



Puma IV Series User Manual



<http://www.GCCworld.com>

NOTICE

GCC reserves the right to modify the information contained in this user manual at any time without prior notice; un-authorized modification, copying distribution or display is prohibited. All comments, queries or suggestions concerning this manual please consult with your local dealer.

Important Information

Thanks for your purchase of GCC *Puma IV Series* Cutting Plotter. For your safety and to optimize the performance of the Puma IV, please read the user manual completely and keep it in a correct location.

PRECAUTIONS IN USE

- For safety concern, please always hold the cutter firmly **from the bottom** when moving it. Do not move the cutter by clasping the depression area on both sides.

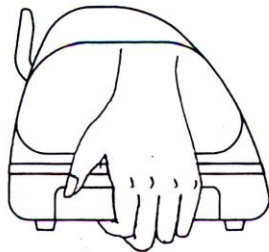

(O)

hold from the bottom

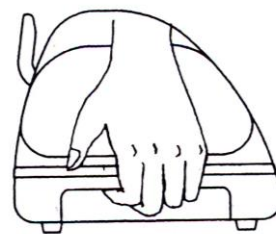

(X)

hold the depression area

- Do not shake or drop the blade holder, a blade tip maybe fly out.
- During operation, keep away from any moving parts of the cutter (such as the carriage, drums). Also be careful that your clothing and hairs do not be caught.
- Always connect the power cable to a grounded outlet.
- Always use the accessory power cable that is provided. Do not wire the power cable so that it becomes bent or caught between objects.
- Do not connect the power cable to branching outlet to which other machines are also connected, or use an extension cable. There is danger of overheating and of misoperation of the machine.
- Keep the tools away from children where they can reach.
- Always put the pinch rollers within position of the white marks.

Contents

Important Information

1. General Information

1.1	Introduction	1-1
1.2	Package Items	1-1
1.3	Product Features	1-2
1.4	Appearance of Puma IV	1-3
1.4.1	The Front View	1-3
1.4.2	The Back View	1-4
1.4.3	The Whole View	1-5
1.4.4	The Left-hand Side	1-6
1.4.5	The Right-hand Side	1-6

2. Installation

2.1	Precaution	2-1
2.2	Stand & Flexible Media Support System (for P4-132LX / P4-132)	2-3
2.3	USB Cable Tie and Saddle	2-7
2.4	Desktop Flexible Media Support System (for P4-60LX / P4-60 only)	2-9
2.5	Blade Installation	2-11
2.6	Cable Connections	2-14
2.6.1	USB Interface	2-14
2.6.1.1	Connecting your GCC cutter	2-15
2.6.1.2	Installing the driver	2-15
2.6.1.3	Driver Un-installation	2-18
2.6.2	RS-232 Interface	2-21
2.6.3	Ethernet Connection	2-21
2.6.4	Data Transmitting	2-26
2.6.5	Printer Sever Shared Setting	2-26
2.7	Software Installation	2-29
2.7.1	GreatCut Installation	2-29
2.7.2	Sure Cuts A Lot Installation	2-34
2.7.2.1	Auto Installation	2-34
2.7.2.2	Manually Activate Software	2-38
2.7.2.3	Re-install Sure Cuts A Lot Software	2-39

3. The Control Panel

3.1	The LCD Panel	3-1
3.2	Menu in On-line Mode	3-2
3.3	Menu in Off-line Mode	3-3
3.4	Menu Items	3-5

4. Operation

4.1	Media Loading	4-1
4.1.1	Loading the Sheet Media	4-1
4.1.2	Loading the Roll Media	4-3
4.2	Tracking Performance	4-6
4.3	Cutting Force and Offset Adjustment	4-6
4.4	When Completing the Cutting Job	4-8

4.5	Puma IV Print Driver setting	4-8
	4.5.1 Puma IV Print Driver setting>Option Page	4-8
	4.5.2 Puma IV Print Driver setting>Paper Page	4-13
4.6	Reference Parameter setting for different materials	4-14

5. Automatic-Aligning System

5.1	Introduction	5-1
5.2	Calibrating the System	5-2
	5.2.1 Media Calibration	5-2
	5.2.2 AAS Calibration	5-2
	5.2.3 AAS II on Puma IV LX	5-3
5.3	Printer Test	5-5
5.4	Registration Mark Offset Range	5-7
5.5	Contour Cutting	5-7
5.6	Tips for AAS	5-9

6. Basic Maintenance

6.1	Cleaning the cutting Plotter	6-1
6.2	Cleaning the Grid Drum	6-2
6.3	Cleaning the Pinch Rollers	6-2

7. Trouble Shooting

7.1	Non-Operational Problems	7-1
7.2	Operational Problems	7-2
7.3	Communication Problems	7-3
7.4	Software Problems	7-4
7.5	Cutting Quality Problems	7-5

Appendix

A-1	Puma IV Specifications	A-1
A-2	Blade Specification	A-2
A-3	CorelDRAW Output Instruction	A-3
A-4	CorelDRAW Plug-In Instruction	A-4
A-5	Illustrator Plug-In Instruction	A-5
A-6	GreatCut Plug-In Instruction	A-6
A-7	SignPal 12 Instruction	A-7
A-8	Sure Cuts A Lot	A-8

Chapter 1 General Information

1.1 Introduction

Puma IV series cutting plotters have been designed to produce computer-generated images or perform contour cutting on sheets or rolls of vinyl media.

This manual covers the following models of Puma IV series cutting plotters:

• P4-60LX / P4-60	for media width: 70mm (2.76") ~ 719mm (28.3")
• P4-132LX / P4-132	for media width: 70mm (2.76") ~ 1470mm (57.87")

1.2 Package Items

The package of the Puma IV model contents the items listed below, please check carefully. If you find any item missing, please consult your local dealer for further assistance.

Standard Item	Quantity																								
1. Cutting Plotter	1																								
2. Stand Set (for P4-132LX / P4-132 only, optional for P4-60LX / P4-60) <ul style="list-style-type: none"> ● 2 piece of T-shape stand ● 1 piece of stand beam ● 20 pieces of M6 screws ● 1 piece of M5 L-shape hexagon screw driver ● 1 piece of Installation Guide for Stand Set 	1																								
3. Flexible Media Support System Package <table border="1" style="width: 100%; border-collapse: collapse;"> <thead> <tr> <th>Items</th> <th>P4-60LX / P4-60</th> <th>P4-132LX / P4-132</th> </tr> </thead> <tbody> <tr> <td>1 set of Roll Media Flange (2 pieces)</td> <td></td> <td>√</td> </tr> <tr> <td>1 set of Roll Holder (2 pieces)</td> <td></td> <td>√</td> </tr> <tr> <td>1 set of Roll Holder Guide Bushes (4 pieces)</td> <td></td> <td>√</td> </tr> <tr> <td>1 set of Roll Holder Support (2 pieces)</td> <td></td> <td>√</td> </tr> <tr> <td>32 pieces of M6 screws</td> <td></td> <td>√</td> </tr> <tr> <td>1 piece of M6 L-shape hexagon screw driver</td> <td></td> <td>√</td> </tr> <tr> <td>1 piece of Roll Base</td> <td>√</td> <td></td> </tr> </tbody> </table>	Items	P4-60LX / P4-60	P4-132LX / P4-132	1 set of Roll Media Flange (2 pieces)		√	1 set of Roll Holder (2 pieces)		√	1 set of Roll Holder Guide Bushes (4 pieces)		√	1 set of Roll Holder Support (2 pieces)		√	32 pieces of M6 screws		√	1 piece of M6 L-shape hexagon screw driver		√	1 piece of Roll Base	√		1
Items	P4-60LX / P4-60	P4-132LX / P4-132																							
1 set of Roll Media Flange (2 pieces)		√																							
1 set of Roll Holder (2 pieces)		√																							
1 set of Roll Holder Guide Bushes (4 pieces)		√																							
1 set of Roll Holder Support (2 pieces)		√																							
32 pieces of M6 screws		√																							
1 piece of M6 L-shape hexagon screw driver		√																							
1 piece of Roll Base	√																								

<p>4. Accessories</p> <ul style="list-style-type: none"> ● 1 piece of User's Compact Disk ● 1 piece of AC power Cord ● 1 piece of data cable (USB cable: 3m) ● 1 piece of Ethernet cable ● 1 set of Blade Holder Assembly (Installed in tool carriage of the cutting plotter) ● 1 piece of Blade (Installed in Blade Holder) ● 1 piece of Safe Blade ● 1 piece of Cutting Pad ● 1 piece of Tweezers ● 1 piece of Promise Card 	<p>1</p>
--	-----------------

1.3 Product Features

The following are the main features of the Puma IV LX / Puma IV series cutting plotters:

- Triple-port connectivity provides you with greater flexibility
- Up to 500 gram cutting force
- Up to 1020 mm per second (40.16 ips) cutting speed (at 45° direction)
- Guaranty 5-meter tracking
- User-friendly and multi-language control panel
- Enhanced Automatic-Aligning System for automatic contour cutting

1.4 Appearance of Puma IV

1.4.1 The Front View (Figure 1-1)

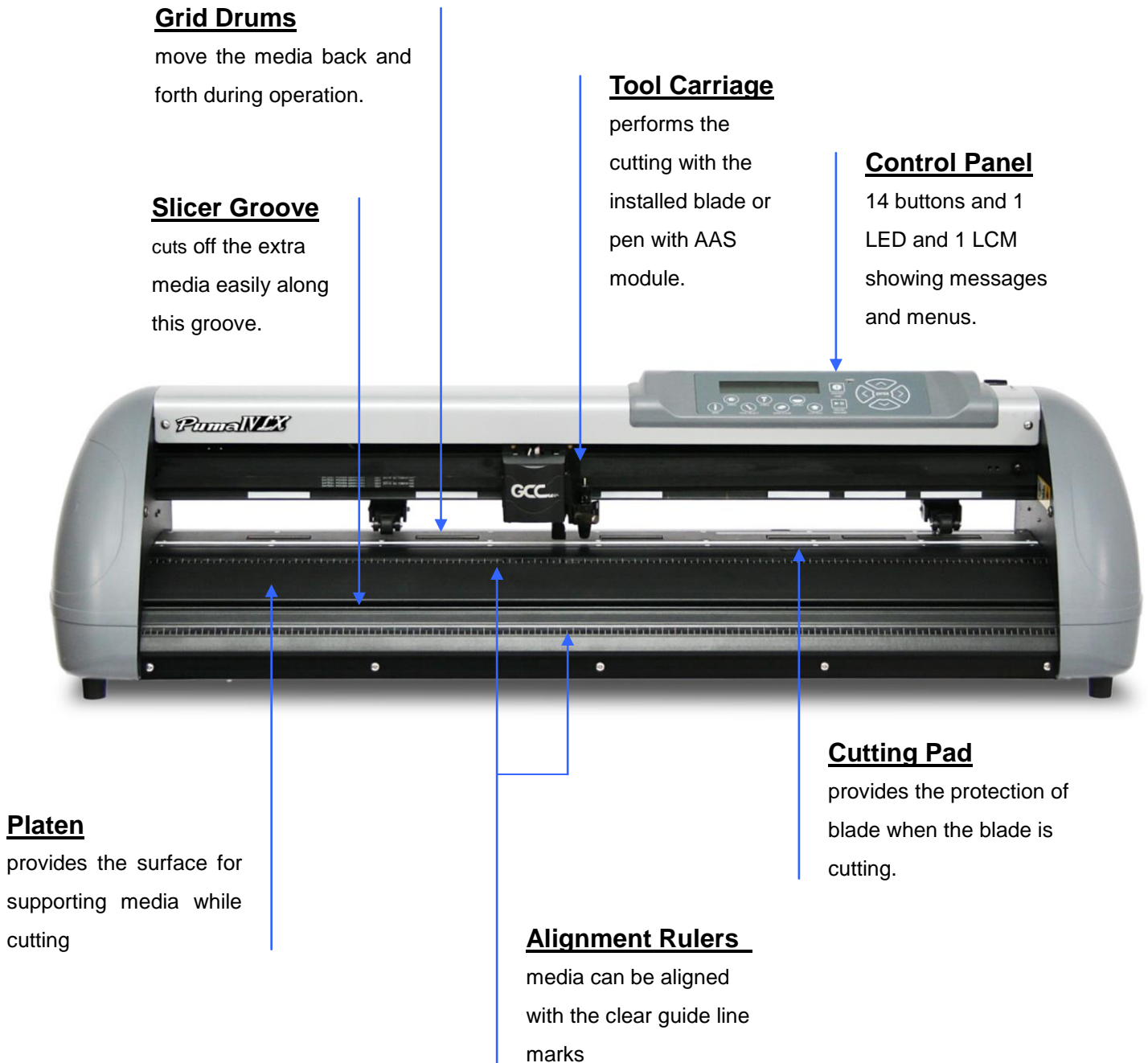

Figure 1-1

1.4.2 The Back View (Figure 1-2)

Lever

raises or lowers
the pinch rollers.

Pinch Rollers

hold the media during cutting.



Figure 1-2

1.4.3 The Whole View (Figure 1-3)

**Stand for Puma IV 60 is an optional item.

**Stand for Puma IV 132S is a standard item.

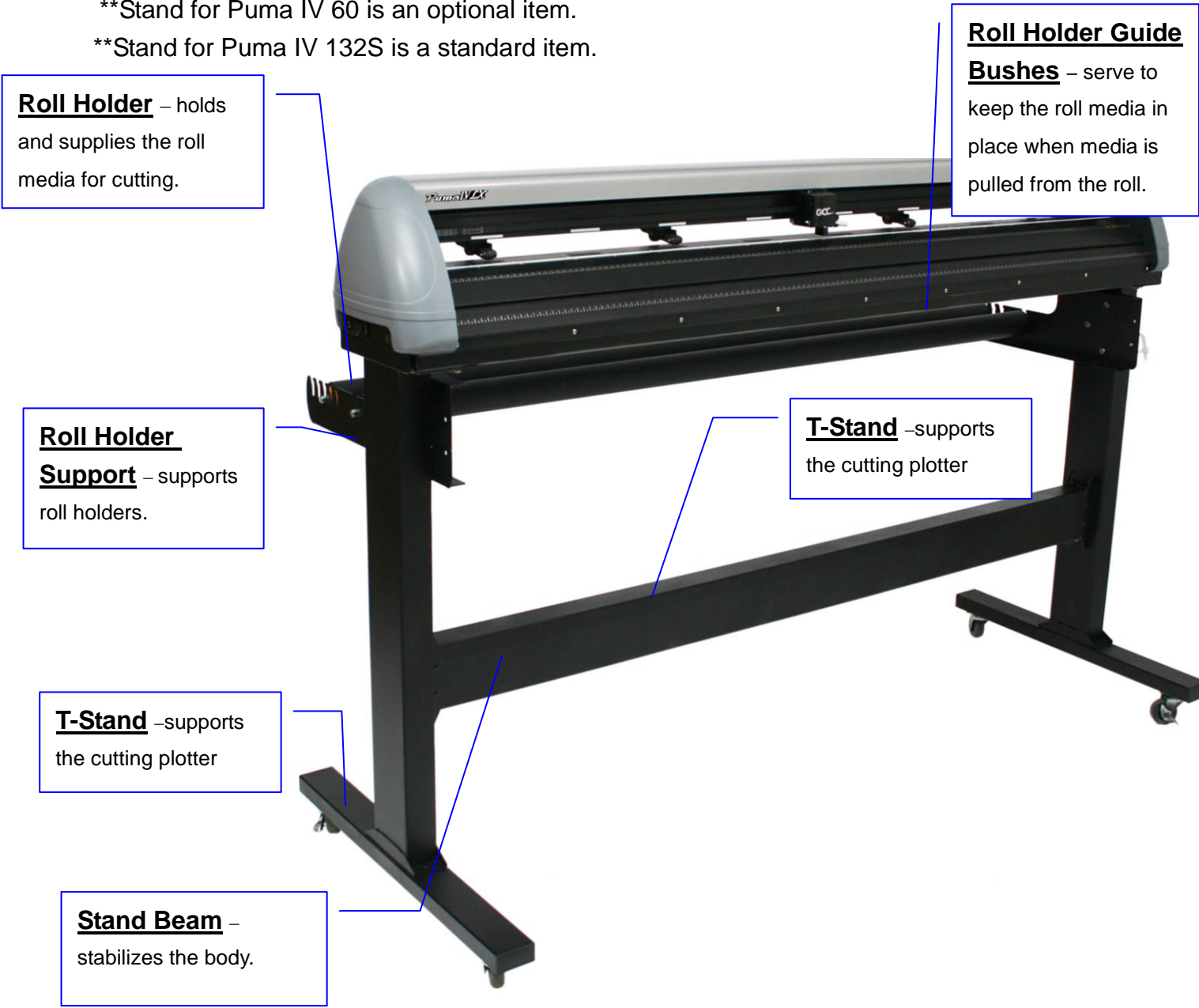

Figure 1-3

1.4.4 The Left-hand Side (Figure 1-4)

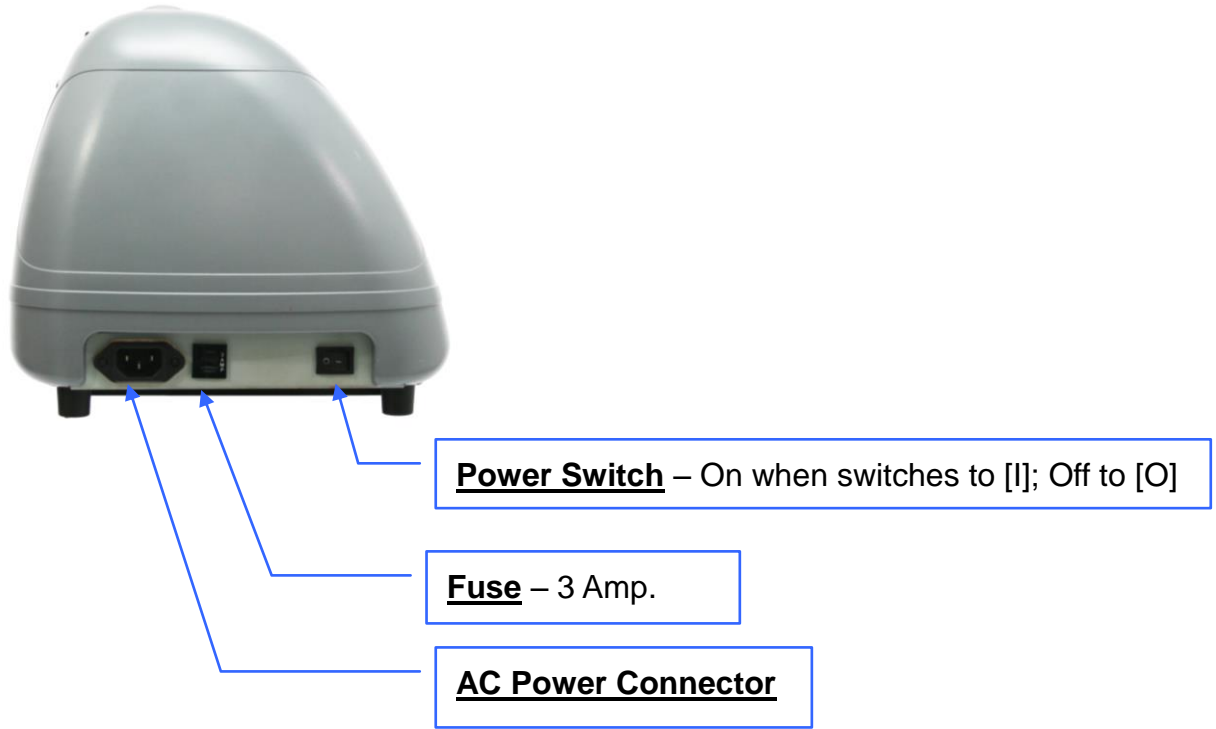

Figure 1-4

1.4.5 The Right-hand Side (Figure 1-5)

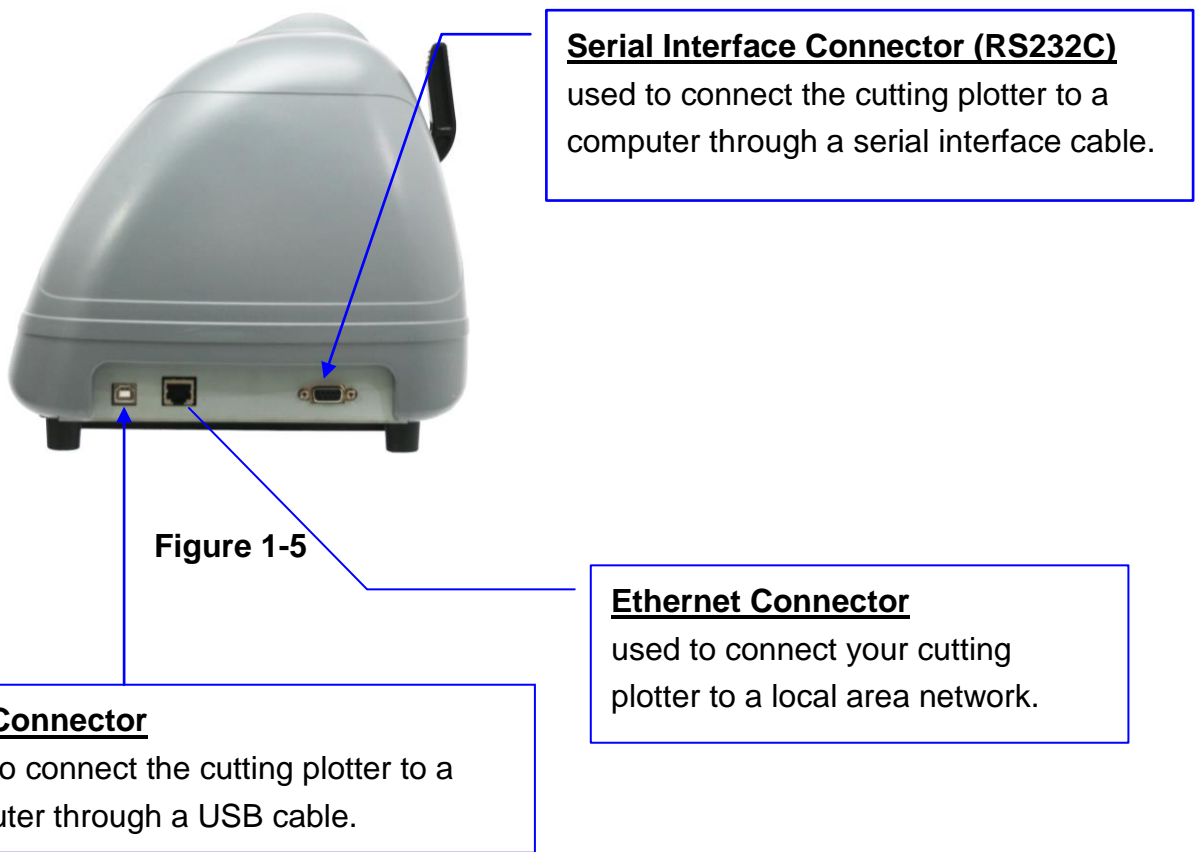

Figure 1-5

Chapter 2 Installation

2.1 Precaution

Notice 1

-
- ❖ Carefully handle the cutter to prevent any injuries.
 - ❖ Make sure the power switch is off before installing the cutting plotter.
-

Notice 2 A proper place for installation the cutting plotter

Please select a proper location that meets the following conditions.

- ❖ The machine can be approached easily from any direction.
 - ❖ Keep at least 60 cm space in front and behind the machine.
 - ❖ Make sure the cutter is placed on a flat, level and sturdy surface
 - ❖ The operation temperature should be between **15 and 30°C (60-86°F)** in the workshop.
 - ❖ Keep the relative humidity between **25% and 75%** in the workshop.
 - ❖ Protecting the machine from dust and air current.
 - ❖ Preventing the machine from direct sunlight.
-

Notice 3 Connecting the Power Supply

Check the plug of the power cord to see if it matches the wall outlet. If not, please contact your dealer.

- ❖ Insert the plug (male) into a grounded power outlet.
 - ❖ Insert the other end (female) of power cord into the AC connector of cutting plotter.
-

Notice 4 Tightening or Loosing Screws with Screwdriver

Whether manual or electric screwdriver, be careful not to use excess torque force when tightening or loosening screws. When tightening or loosening iron and stainless steel screws, please refer to the following screw torque standard table, other materials screws are not included.

Screw diameter	Torque value (kgf-cm)
	Torque standard for high hardness materials
M3	6
M4	16
M5	30
M6	50

2.2 Stand & Flexible Media Support System (for P4-132LX / P4-132)

Please follow procedure below to assemble stand and media support system.

Step 1 Please examine supplied items in the accessory box of stand carton before you install:

Stand is a optional item for Puma IV 60 LX / Puma IV 60, Item List :

- 2 piece of T-shape stand
- 1 piece of stand beam
- 20 pieces of M6 screws
- 1 piece of M5 L-shape hexagon screw driver
- 1 piece of Installation Guide for Stand Set

Step 2

- Remove the plotter body and the accessories from the shipped carton.
- Place the stand beam upright on the T-stand and follow the number **1** **2** to assemble (See Figure 2-1 & 2-2).
- There is hexagon socket head screws fasten on the T-stand on both side taken as locating pins.

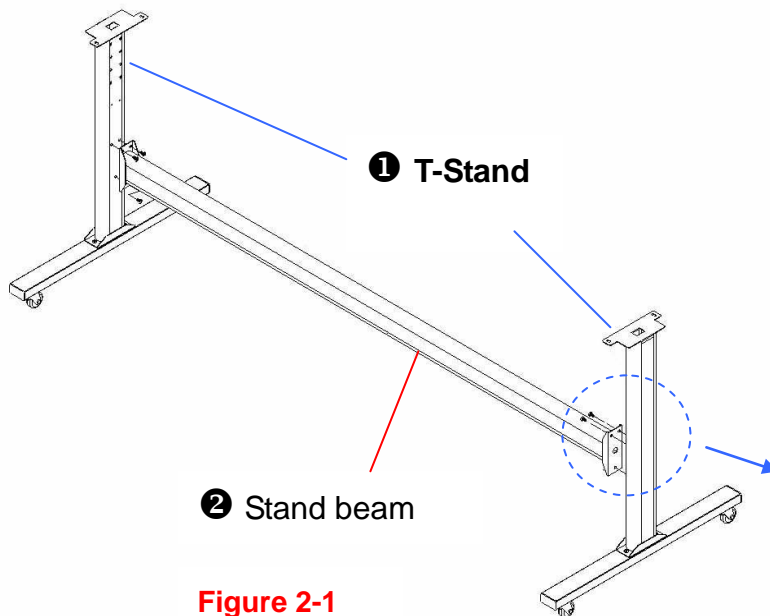

Figure 2-1



Figure 2-2

Step 3 Position the stand beam perpendicularly to part ❶ and put the screws into the holes and tighten them as Figure 2-2. Then the complete picture of stand will be like Figure 2-1.

Step 4 Remove the cutting plotter from the carton. Position your stand under the plotter, on the bottom of the plotter, there is one hole on each side in the position corresponding to the locating pins, so the locating pins can be located into the holes. Then insert the screws into the holes on the stand to fix the plotter and tighten them up as shown in Figure 2-3.

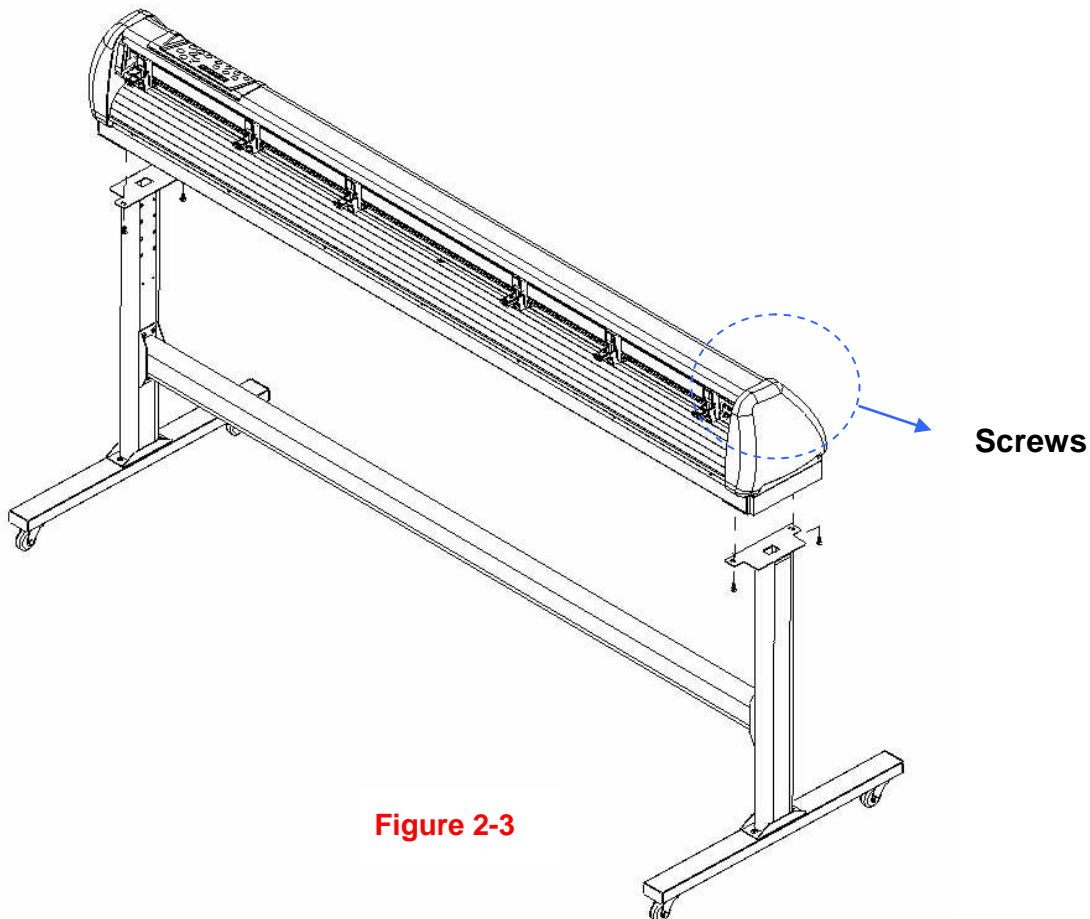

Step 5

Insert the roll holder support with the screws into the holes of the stand, and then tighten them up as shown in Figure 2-4. You could decide roll holder support's position by inserting into different holes.

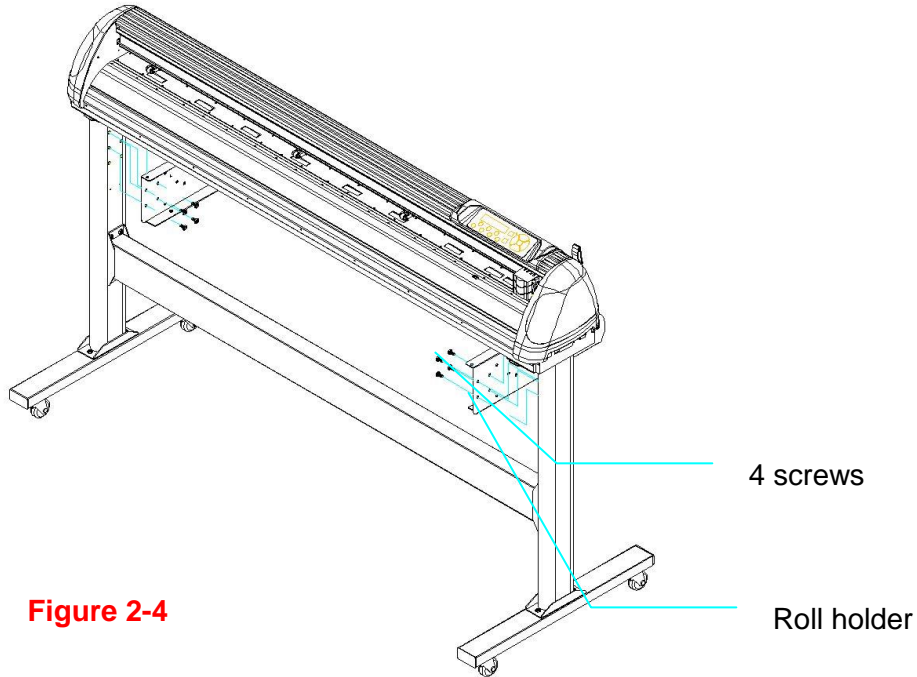

Figure 2-4

Step 6

Place two roll holders onto the roll holder support and ensure the white protrusion is wedged in the groove. (Figure 2-5)

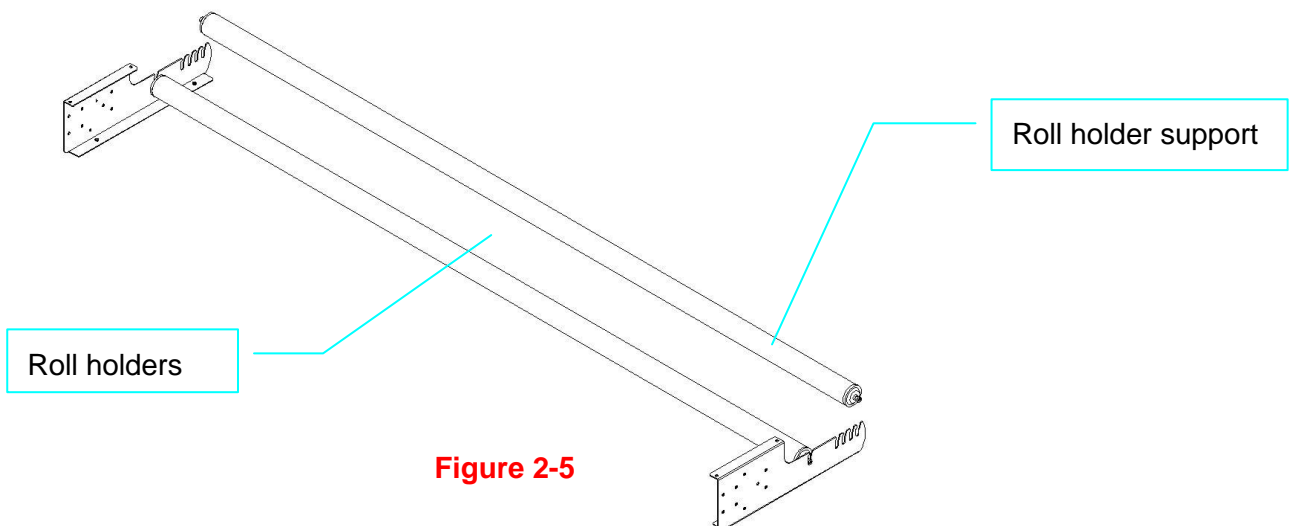

Figure 2-5

Step 7

Lastly, the complete picture will be shown like below. (Figure 2-6)

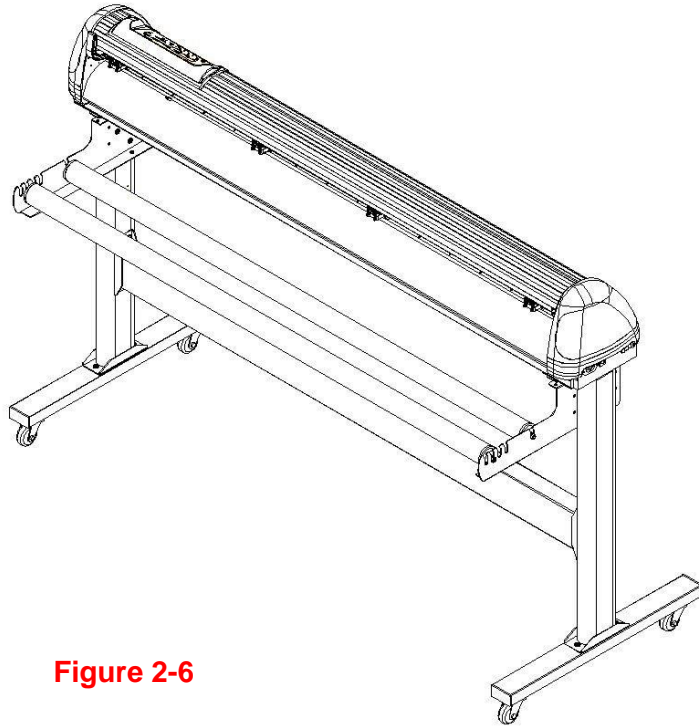
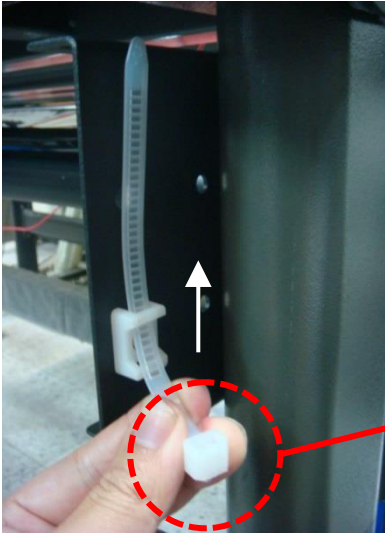

Figure 2-6

2.3 USB Cable Tie and Saddle

The USB cable tie and saddle assembly for the stands with Flexible Media Support System only.

Step 1 Insert the cable tie into the upper hole of cable saddle from bottom to top.



This side up

Step 2 Place the USB cable into the cable tie and tighten the cable tie.

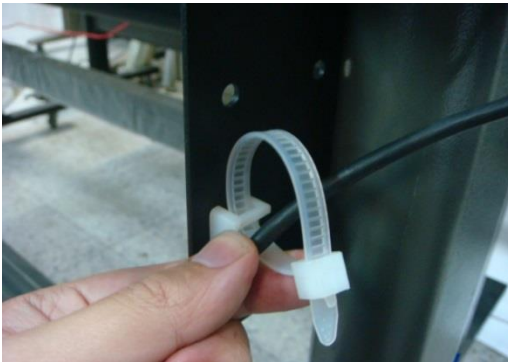

Step 3 Insert the cable tie end into the lower hole of cable saddle to finish the job.



Untied way: pull out the cable tie → pull up the pin → release the cable tie.

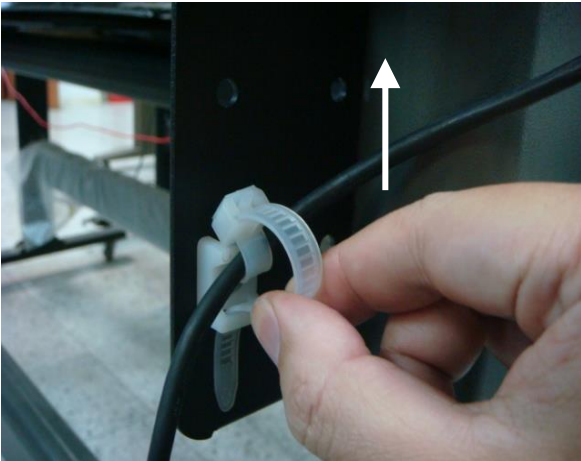

Pull out the cable tie

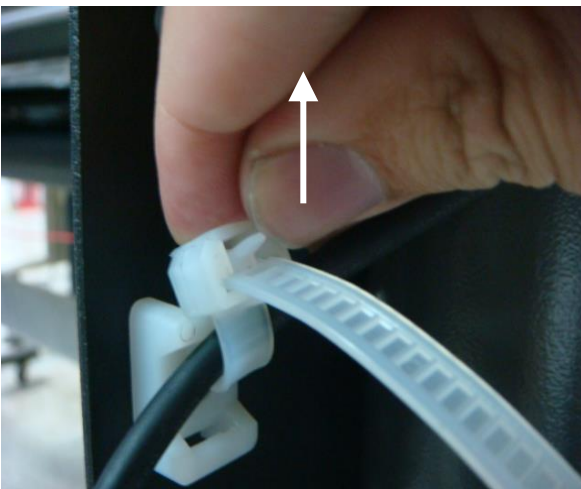

Pull up the pin

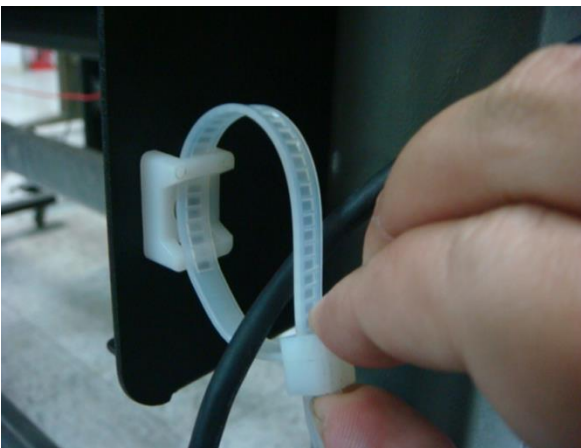

Release the cable tie

2.4 Desktop Flexible Media Support System (for P4-60LX / P4-60 only)

Step 1

Check three spacer supports on the back of the machine.

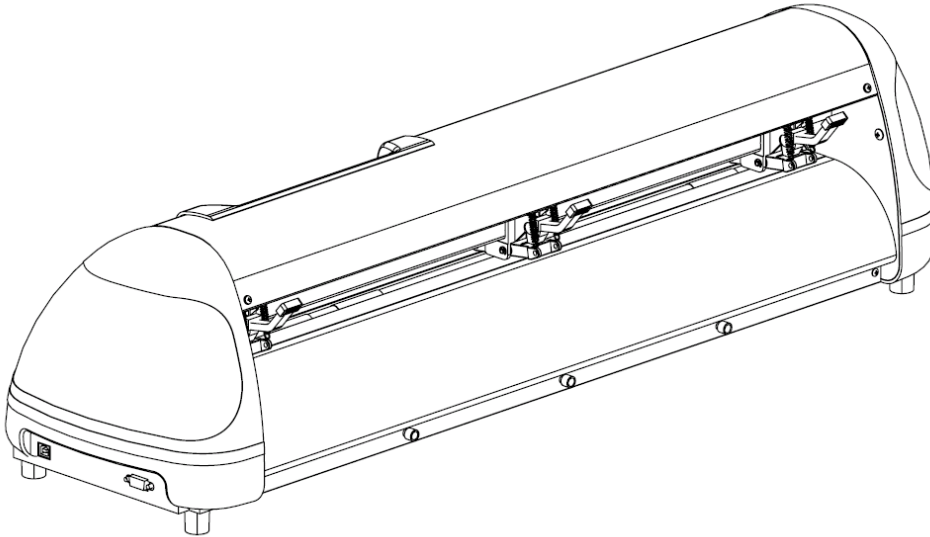

Step 2

Insert the left and right roll holder base into the spacer supports on the left and right side when 2 inches roll media is used.

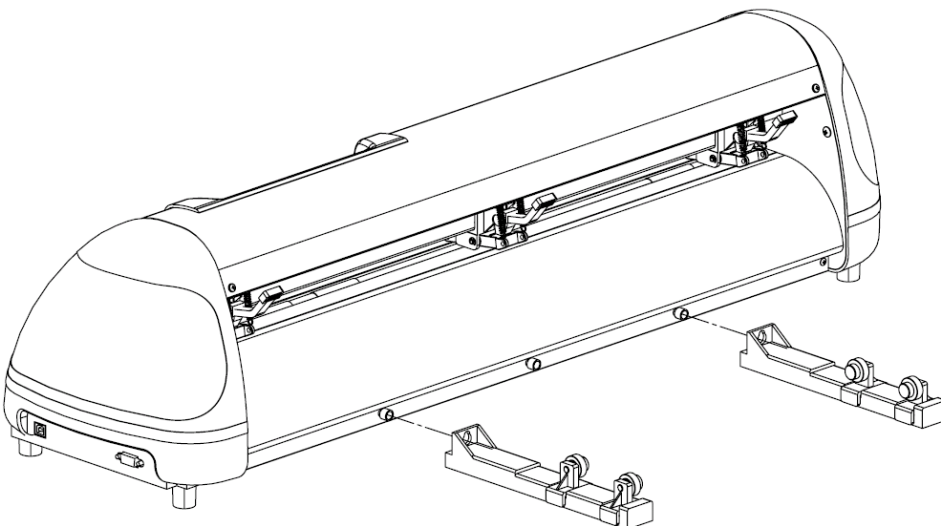

Step 3

Press the roll holder base and the installation is complete.

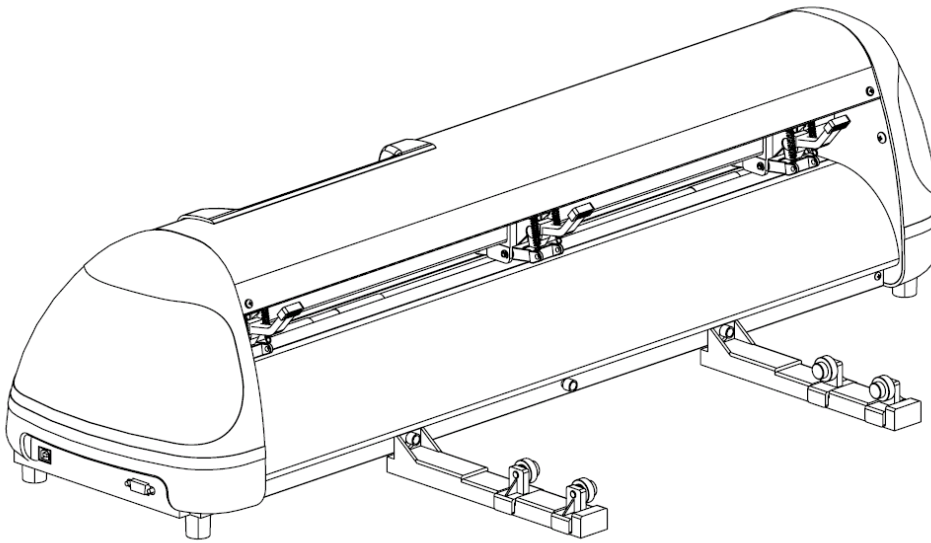

Note: Insert the left roll holder base into the middle spacer support and right roll holder base into the right one when 1 inches roll media is used.

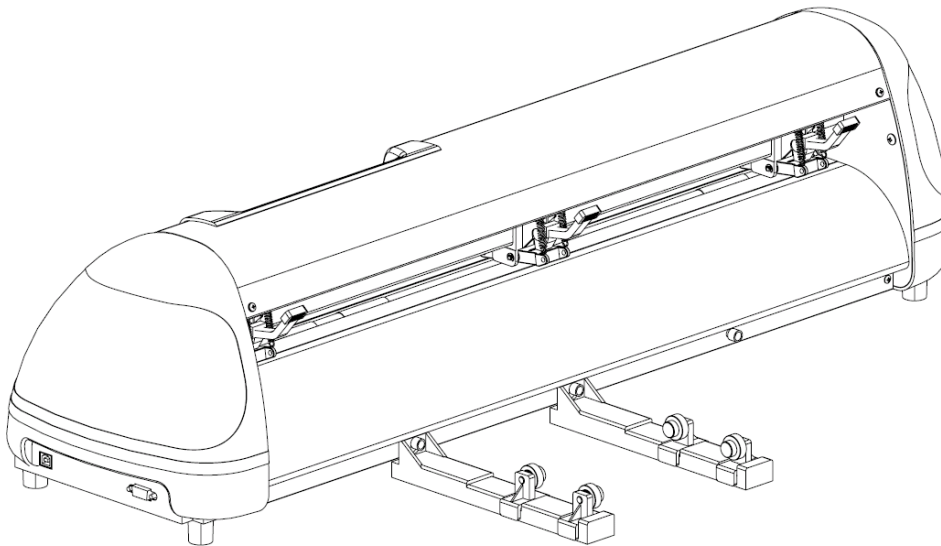

2.5 Blade Installation

! Caution

Do not touch the tip of the blade by your fingers.

! Notice

The blade is a consumable item, which will affect the cutting quality significantly. Please replace with a new blade when having the following situations:

1. The tip of blade is broken.
2. The cutting traces are not as good as they were.
3. Uncut area remains the same even the blade force has been raised significantly.

Figure 2-11 is the picture of the blade holder. Insert a blade into the bottom of the blade holder. Pushing the pin on the top of blade holder can remove the blade. Be sure to keep your fingers away from the blade tip.

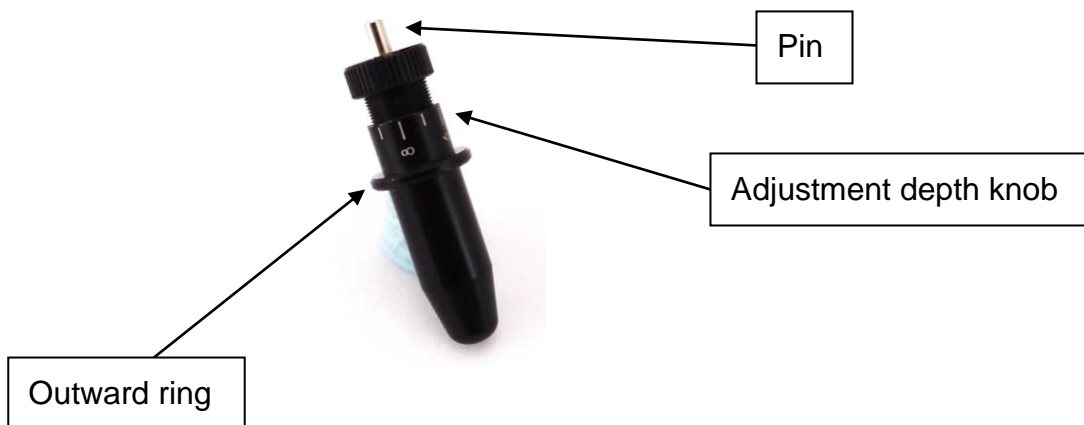

Figure 2-11

Step 1 Install blade. (Figure 2-12)

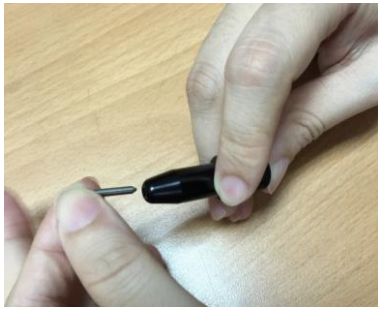

Figure 2-12

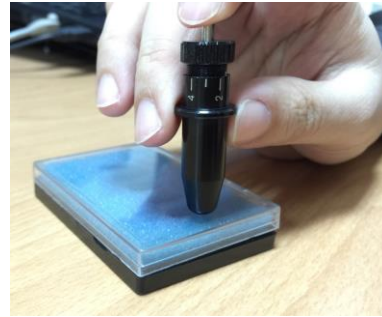

Figure 2-13

Step 2 Push the blade to the bottom of the blade holder. (Figure 2-13)

Step 3 Adjust the blade tip to suitable length by rotating “Blade tip adjustment screw” clockwise or counterclockwise. (Figure 2-14)



Figure 2-14

Tips:

“The proper length” means the blade length is about 0.1mm more than film’s thickness. For example, if the thickness of film is 0.5mm, then the blade length is properly adjusted to 0.6mm and it can completely cut through the film layer without cutting through the paper backing.

Step 4 Insert the blade holder into tool carriage. Please note the outward ring of the holder must put into the groove of carriage firmly (Figure 2-15) and lock the grip. (Figure 2-16)



Figure 2-15



Figure 2-16

Step 5 Reverse steps mentioned above to remove the blade holder.

Step 6 Press the push-pin to remove the blade from the blade holder when replacing blade. (Figure 2-17)



Figure 2-17

2.6 Cable Connections

Puma IV communicates with a computer through **USB (Universal Serial Bus)**, a **Serial port (RS-232C)** or **Ethernet**. This chapter shows you how to connect the cutting plotter to a host computer and how to set up the computer/cutting plotter interconnection.

!! Notice: When USB connection is enabled, serial port will be disabled automatically.

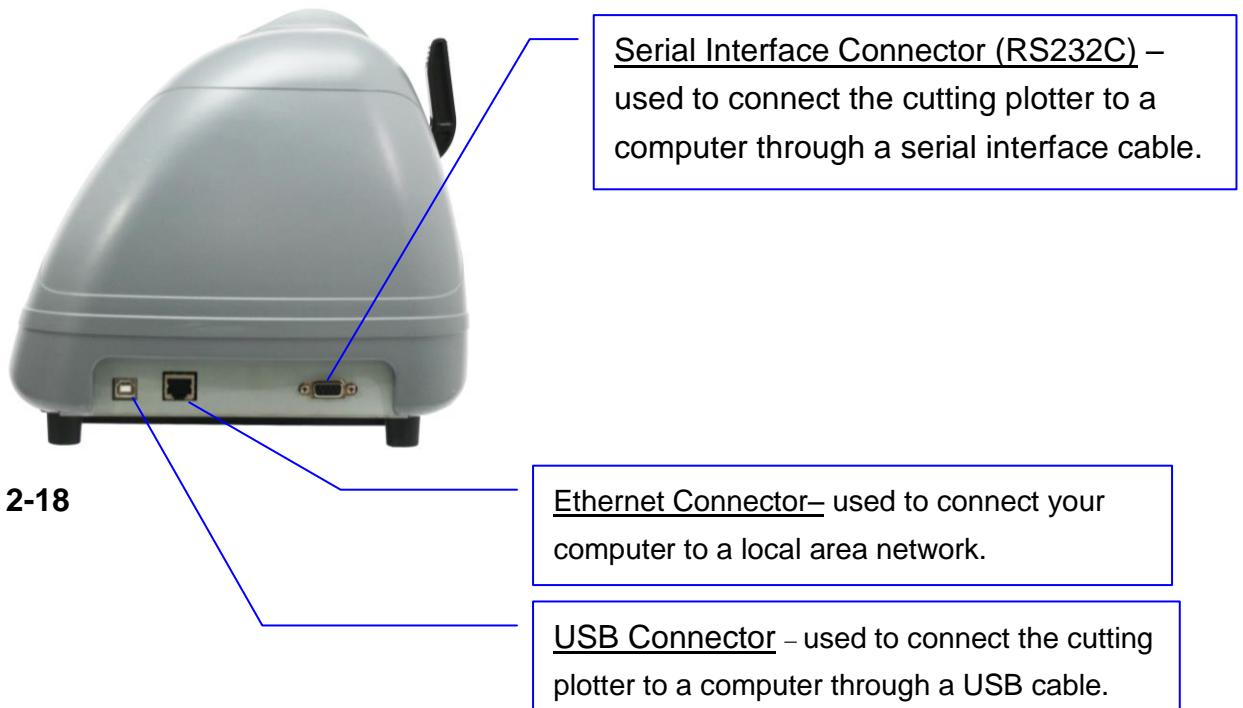

Figure 2-18

2.6.1 USB Interface

Puma IV build-in USB interface are based on the Universal Serial Bus Specifications Revision 2.0 (Full Speed).

2.6.1.1 Connecting your GCC cutter

Turn on the machine.

Connect the USB connector to the machine and then USB driver will installed automatically. It will take a few minutes to find the device. Please **DO NOT** disconnect the USB cable until the installation has completed.

You can double click the USB icon on the taskbar to make sure the USB device is detected.

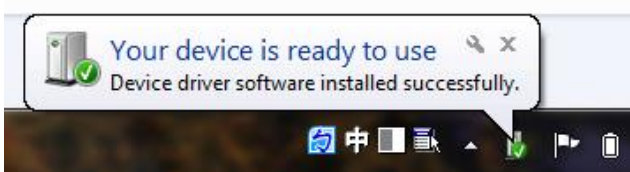

2.6.1.2 Installing the driver

Use the USB One-click Installation for quick driver installation. Follow the simple steps below for driver setup.

Caution!!

- ✓ If you are using Windows 7 and above as your operating system, make sure you log in using the “Administrator” account.

Step 1 Put the installation DVD into your CD-ROM. **Please make sure that the USB device is connected before you start the driver installation.**

Step 2 Choose the model you want to install from the driver list and click on Windows Driver (Win 7 and Above) (Automatic Detection) or Windows Driver (Win 7 and Above) (Manual Selection) to start installing the Driver and AAS plug-in.



Step 3 Click “Next” to start the driver installation.

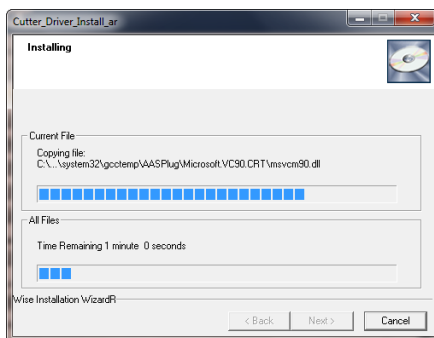

Step 4 If you were Windows 7 and above users, please click on the **red words** to instruct you how to disable Windows Update to allow success driver installation. And then click OK to next step.

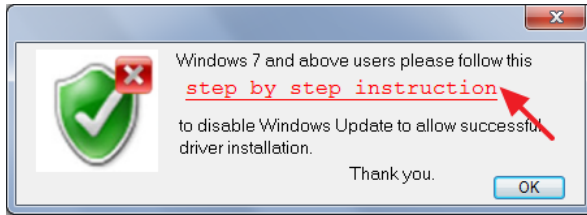

Step 5 Please make sure the cutting plotter is powered on and connected to the USB device, and then click OK to next step.

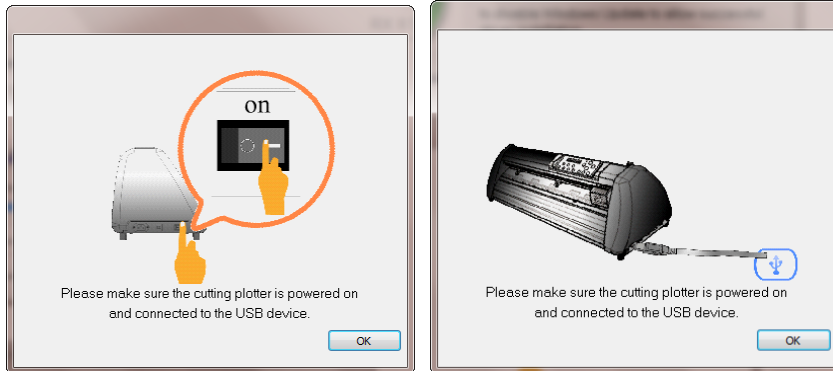

Step 6 Confirm to close all running application programs before you start installing the driver, and then click OK.



Step 7 The installation will take a few minutes to complete and you will see a message below and click on "OK" upon completion. Enjoy your GCC cutter!

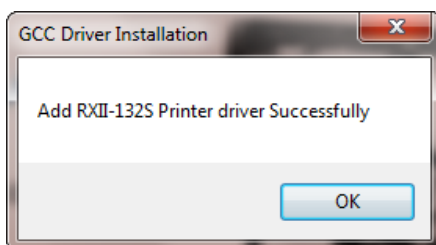

Step 8 If you want to install AASII VBA on CorelDRAW and Adobe Illusatrator, exit CorelDRAW and Adobe Illusatrator program, and then click on "Install."

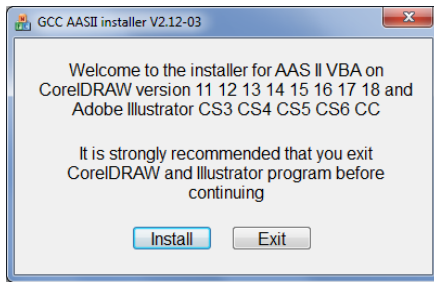

Step 9 Check Install Message to confirm CorelDRAW and AI version and then click OK.

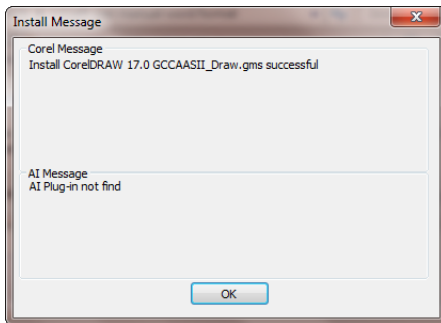

Note:

If the driver is being installed for a second time, the user will be prompted as to whether a second copy of the driver installation is required.

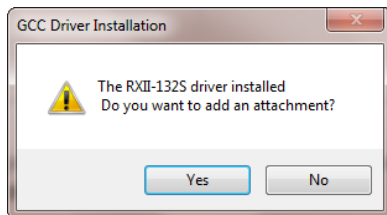

If the user selects yes, a second copy of the driver will be installed.

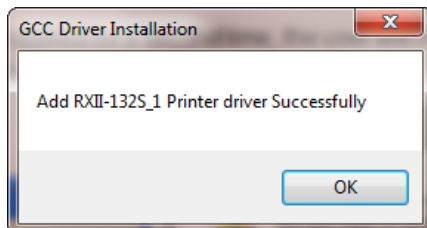

(3) For users who have upgraded Adobe Illustrator or CorelDRAW, please go to the **AAS Installer** page in the **Printer Properties** window and click **“Install”** to access the latest version of GCC AAS Plug-in.

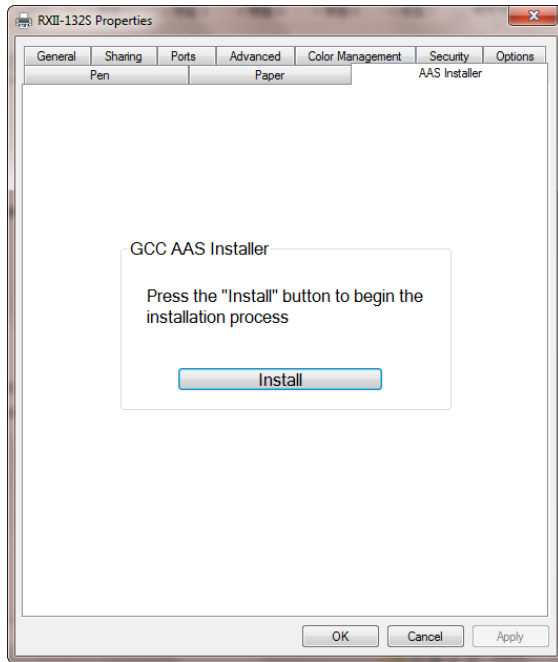

2.6.1.3 Driver Un-installation

You have to remove previous version driver installed on your PC system completely before you can install the latest version successfully. Please refer to below steps.

Step 1 Go to Control Panel\Hardware and Sound\Devices and Printers window. Right click the printer and select **“Remove device.”**

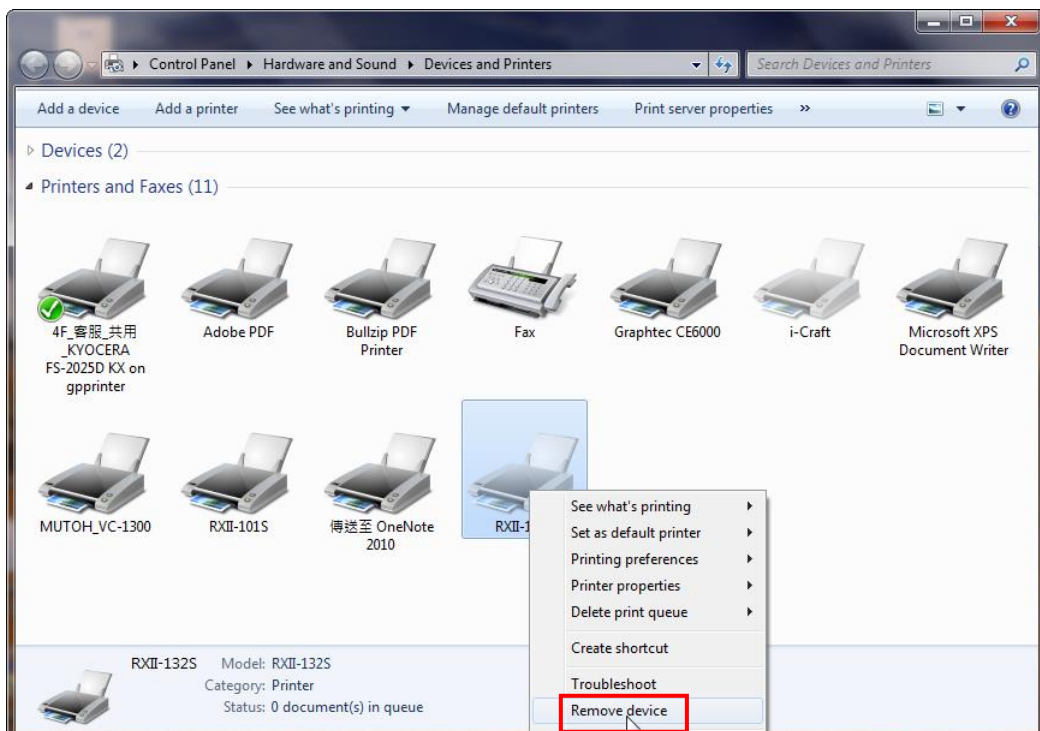

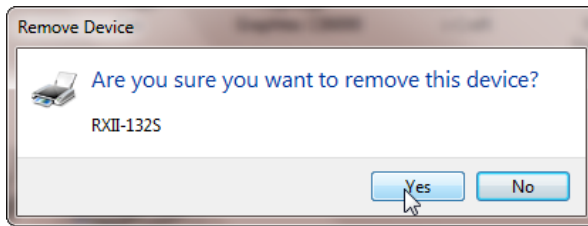

Step 2 After removing the unit, click on any printer on the page and select “**Print server properties.**” (For Win 7 and above)

Or right click on blank space and then select “**Print server properties.**” (For Windows XP)

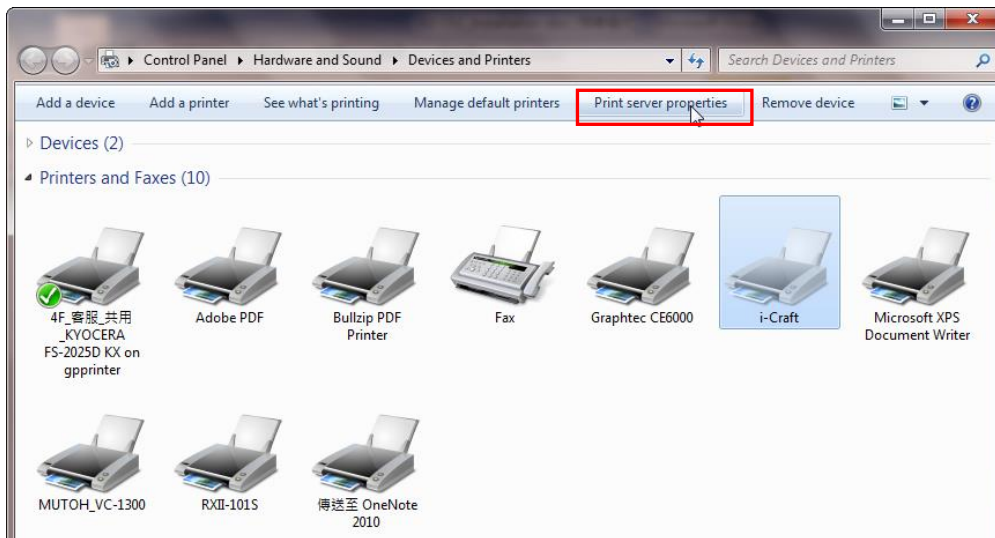

Step 3 Select “Driver” page

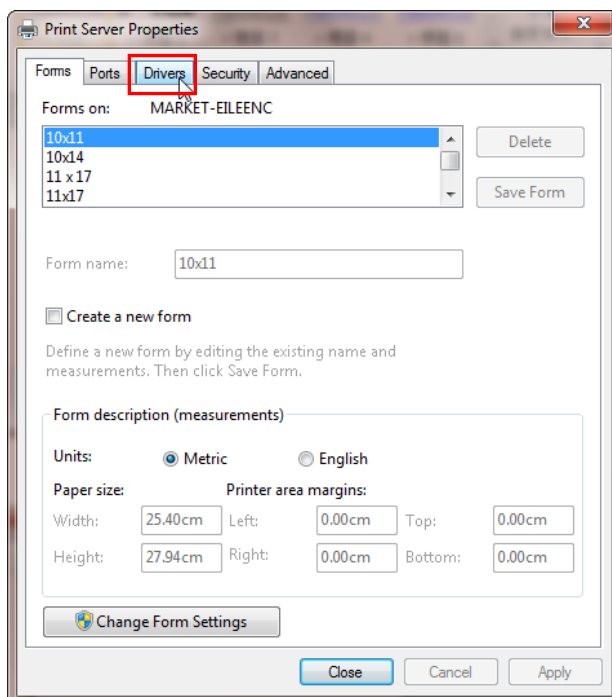

Step 4 Select the model and click on “Remove”.

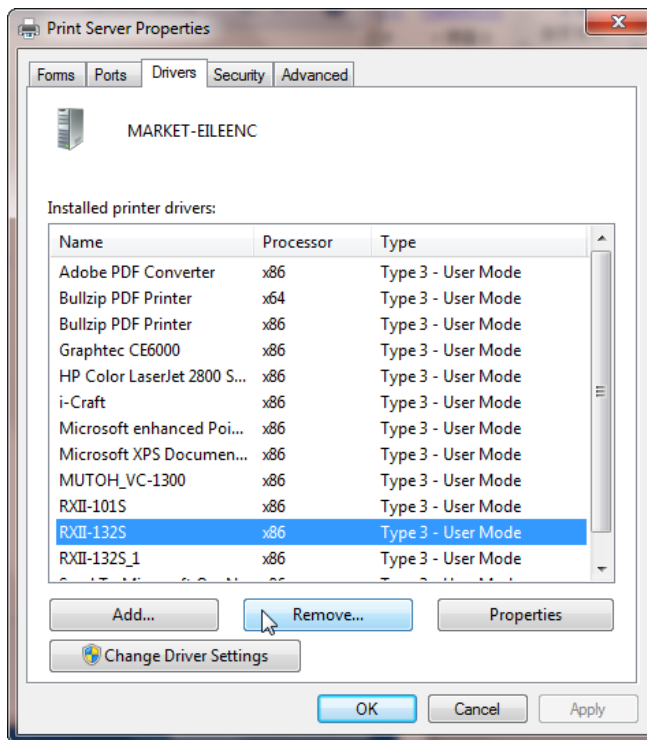

Step 5 Select “Remove driver and driver package” and click OK.

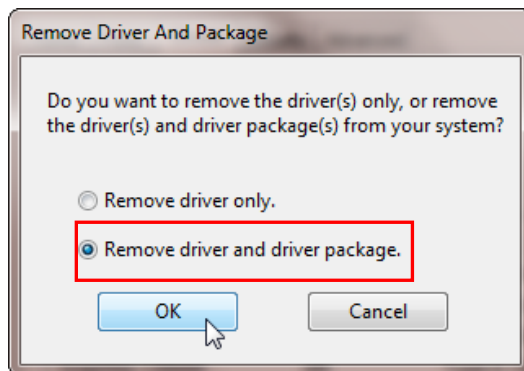

Step 6 Click Yes and then click “Delete” and “OK,” and the driver installed on PC is completely removed.

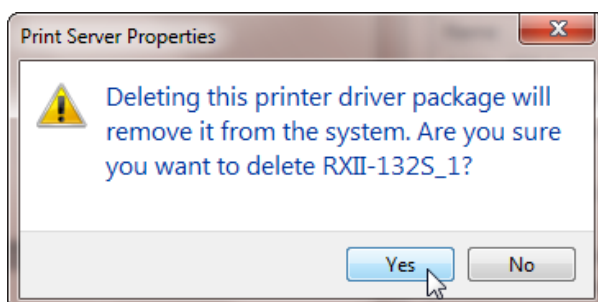

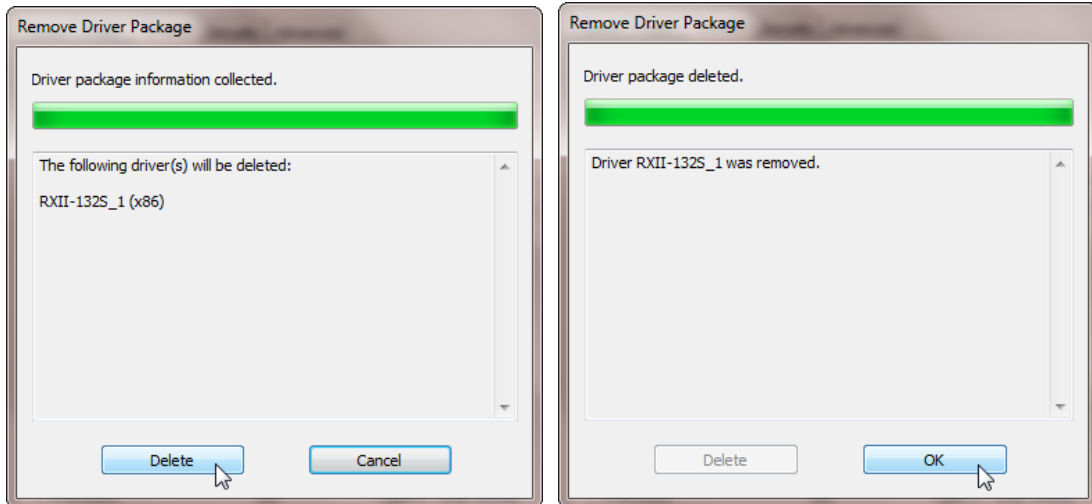

2.6.2 RS-232 Interface

■ Connecting to the RS-232 (Serial) Port

1. For IBM PC, PS/2 users or compatibles, connect the RS-232C cable to the serial connector of the assigned serial port (COM1 or COM2) of your host computer.
2. Set up the communication parameters (Baud Rate and Data Bits/Parity) to match the setting of software package, refer to chapter 3 – “Misc” key description.

Caution!! Please turn off the plotter before plugging the RS-232C

2.6.3 Ethernet Connection

I. Networking Connectivity Setup

Step 1 Connect the LAN port and Ethernet port on GCC cutting plotter with RJ45 Ethernet cable, and turn on the machine.



Step 2 Press **On/Off line** and then **MISC** button on your control panel.

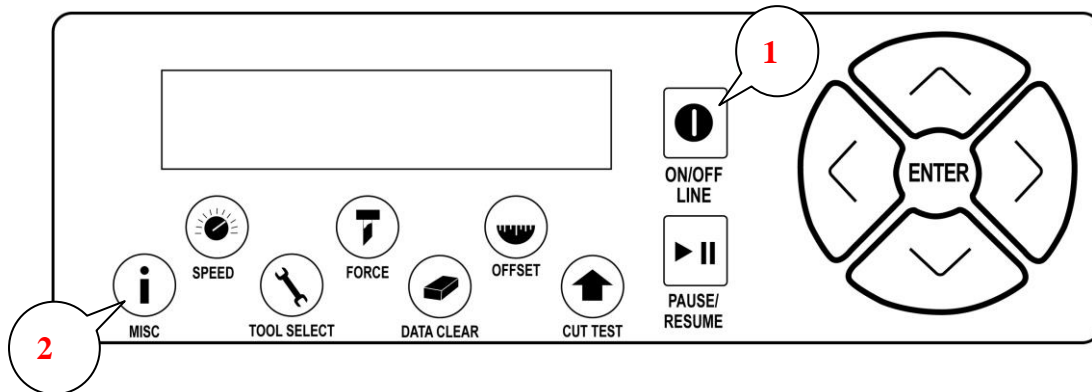

Step 3 Go to the **DHCP** page and select **Enable** through the up and down arrow keys, then press Enter.

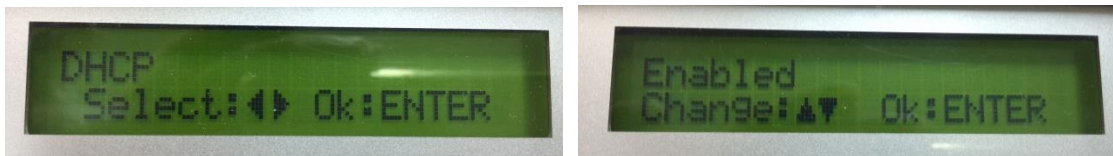

Step 4 The IP Address will be shown on the screen automatically. Please make notes of it.



II. Ethernet Connectivity Setup

There are two ways to output your plot through Ethernet. If you output your plot through GreatCut, please follow the instruction **I. Output through GreatCut**; if you output your plot through Adobe Illustrator or CorelDRAW, please follow the instruction **II. Output through the Ethernet Driver**.

I. Output through GreatCut

GreatCut is a plug-in for CorelDRAW and Illustrator. (GreatCut installation please refer to chapter **2.9.1**)

Instruction of Ethernet settings for GreatCut

Step 1 Open GreatCut and create a new file and cutting line.

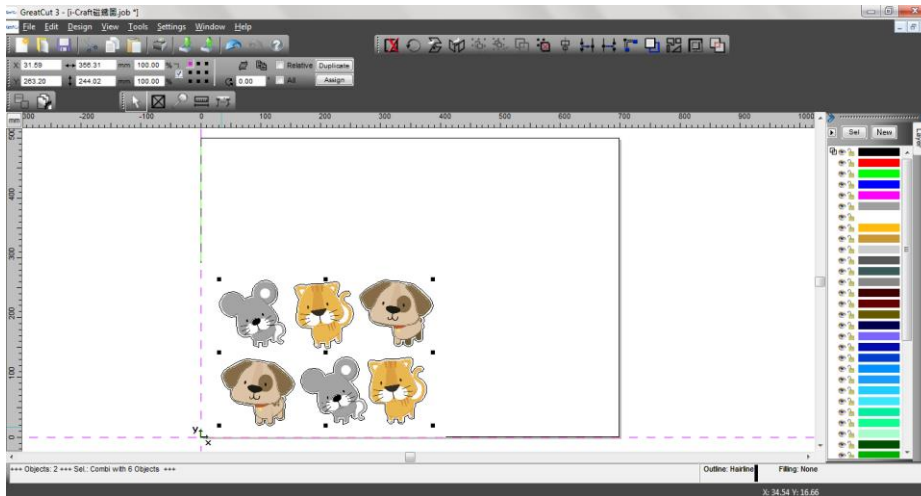

Step 2 Go to **Output Devices** under Settings.

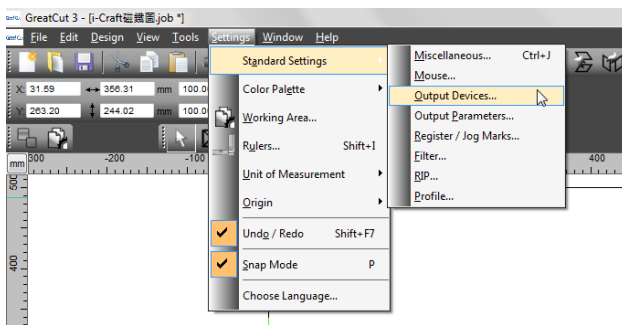

Step 3 Select a model at Driver in Setup Device window

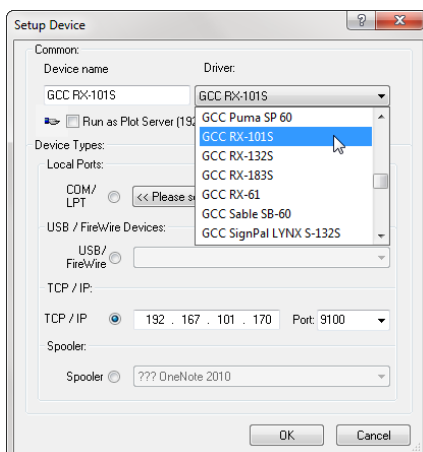

Step 4 Input the IP address you had acquired from the control panel to the TCP/IP. Click OK to complete settings.

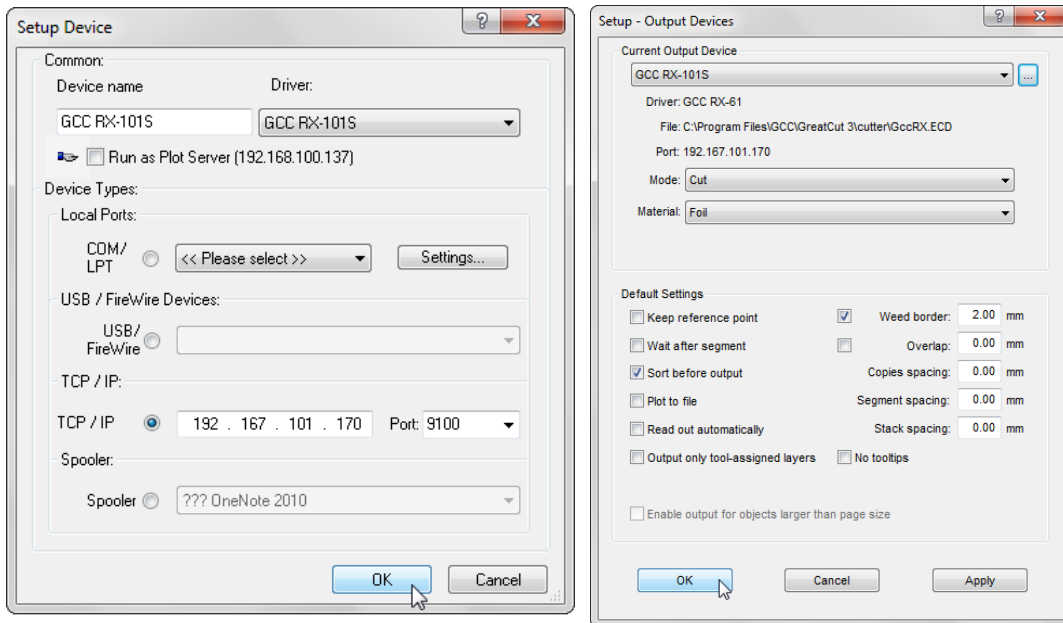

Step 5 Go to **Output** under File to check the settings.

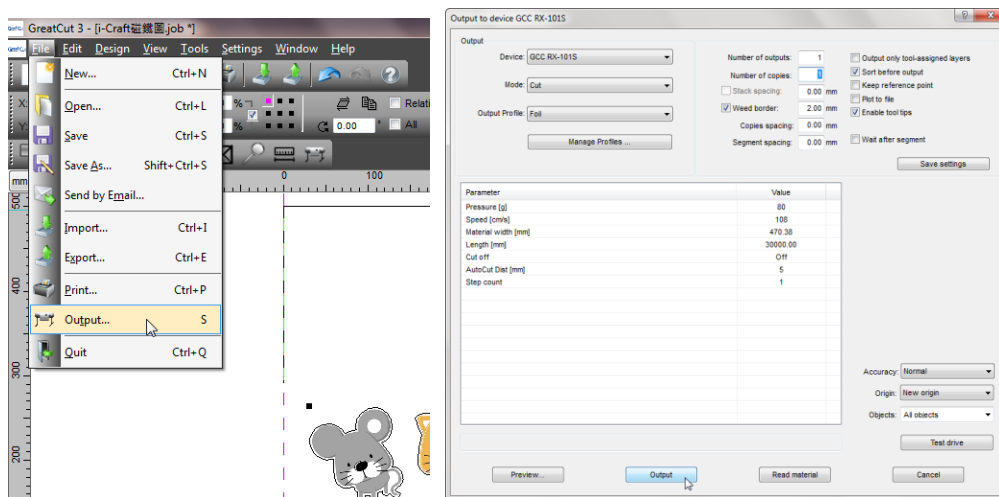

Complete the driver installation process and your GCC Cutting Plotter is now allowed to network.

Note: If you want to add new local device, please go to **Output Devices** under Settings, and press the button on the right of Current Output Device and select **Add local device** (if the device has been installed but you wanted to output through another device, please select **Change** to set the IP address of another device).

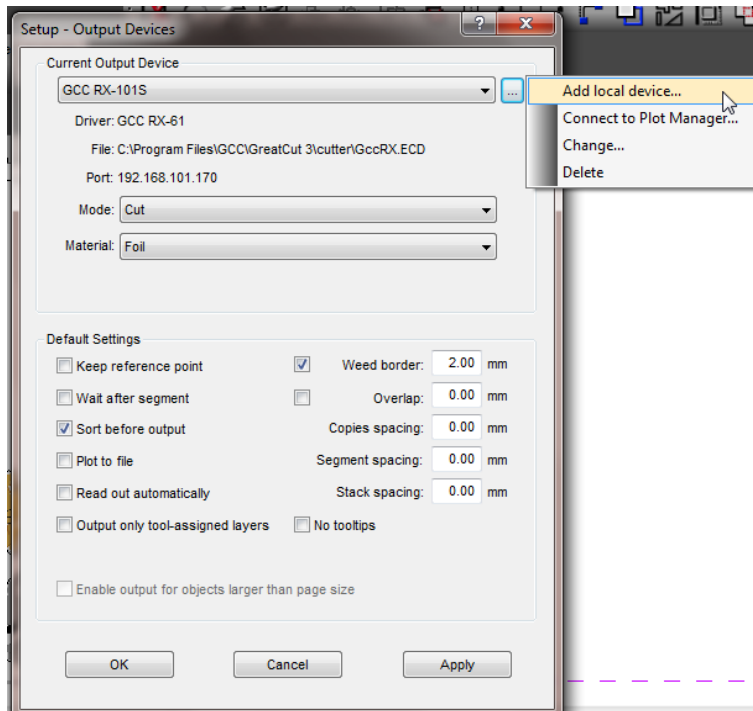

II. Output through Ethernet Driver

Step 1 Connect Ethernet cable to PC and install **Cutter Ethernet driver**. Then click OK to continue.

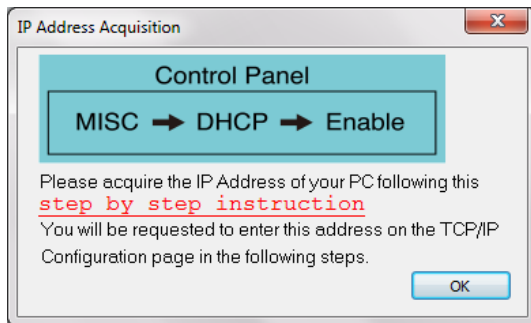

Step 2 Enter the IP Address shown on the control panel and select the model. (Please refer part 1 instruction.)

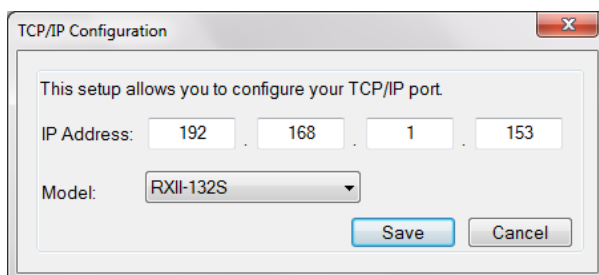

Step 3 The driver is installed. You can output from AI or CoreIDRAW directly now.

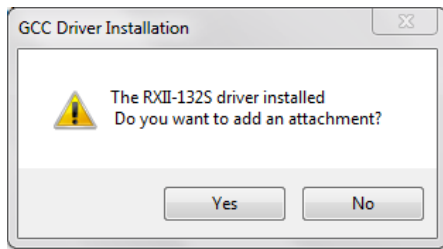

2.6.4 Data Transmitting

There are two options to transmit the data from the computer to the cutting plotter:

Option 1: With proper interface settings, the data can be transmitted from your application software package to the cutting plotters directly.

Option 2: Most cutting software packages are able to emulate **HP-GL** or **HP-GL/2** commands. As long as the file is **HP-GL** or **HP-GL/2** format, the cutting plotter can output the data precisely.

2.6.5 Printer Sever Shared Setting

In "A-PC", set the printer driver as a shared printer, then use B-PC to connect A-PC's printer driver via Intranet.

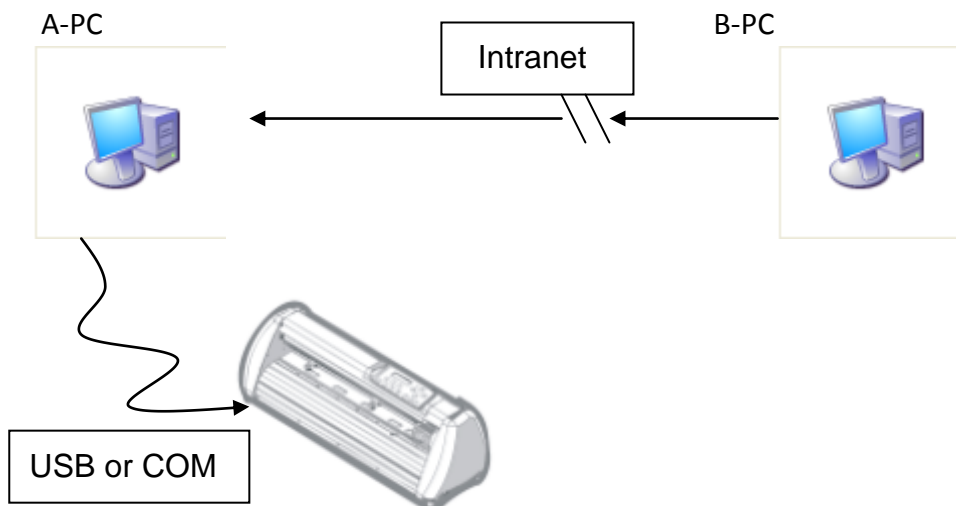

Step 1 Set A-PC's printer driver as a shared printer (Right-click on printer icon, choose "Printer properties". Click "Sharing" tab then check "Share this printer.")

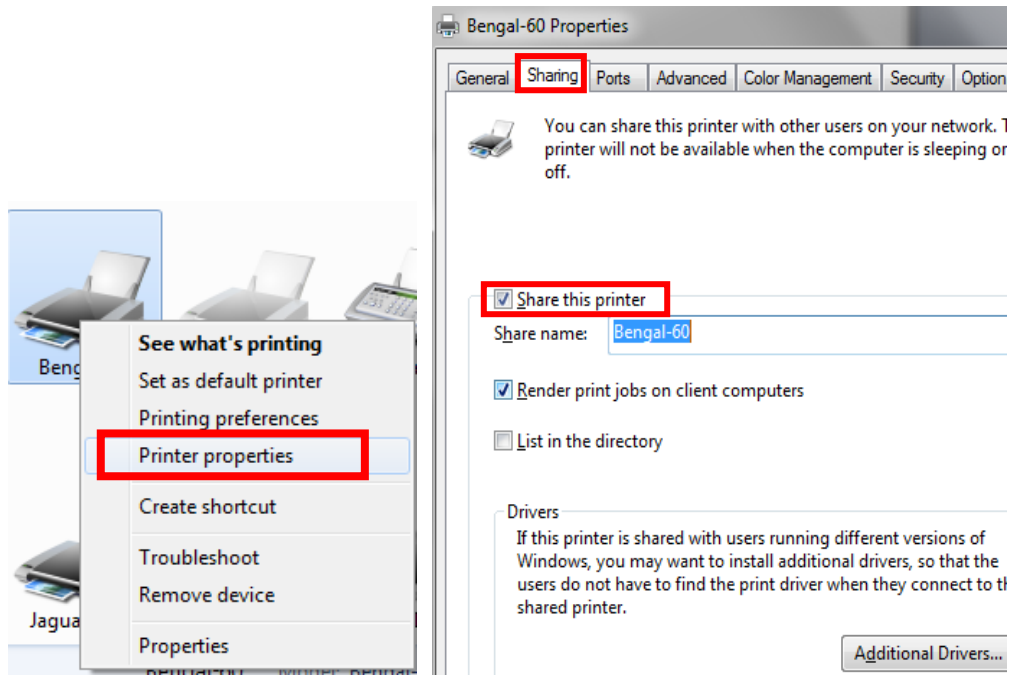

Step 2 Click “Advanced” tab, then choose “Print directly to the printer” option.

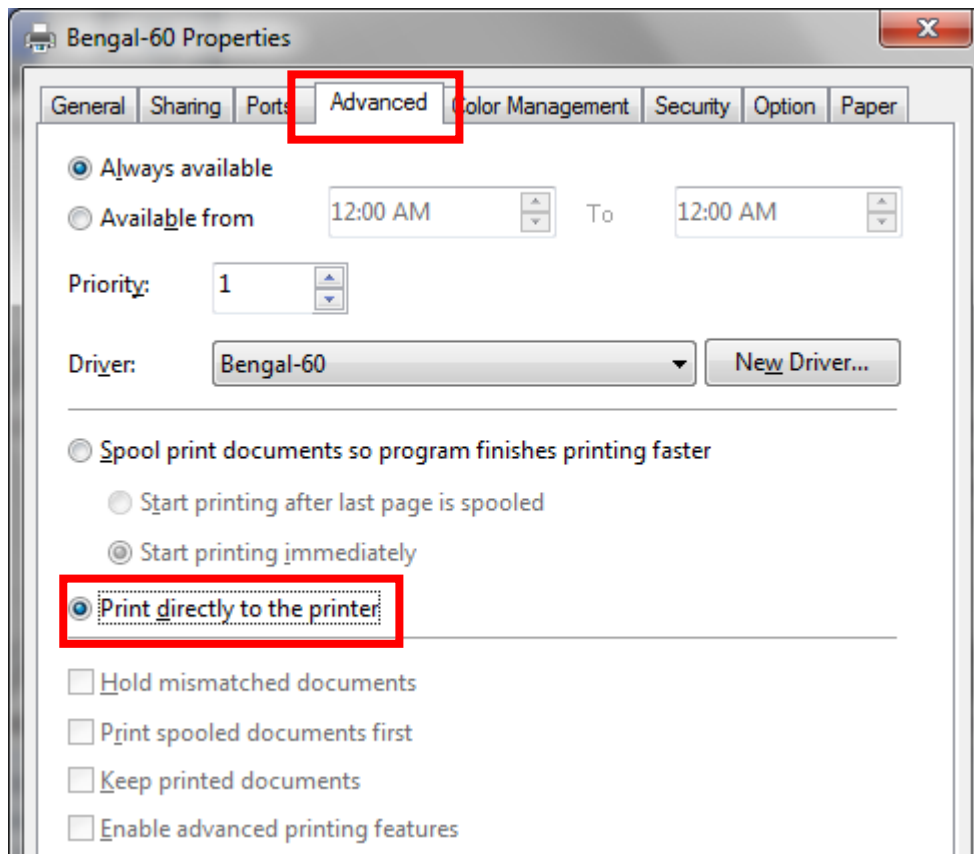

Step 3 Send a job from A-PC to the machine to check if A-PC is connected to the machine.

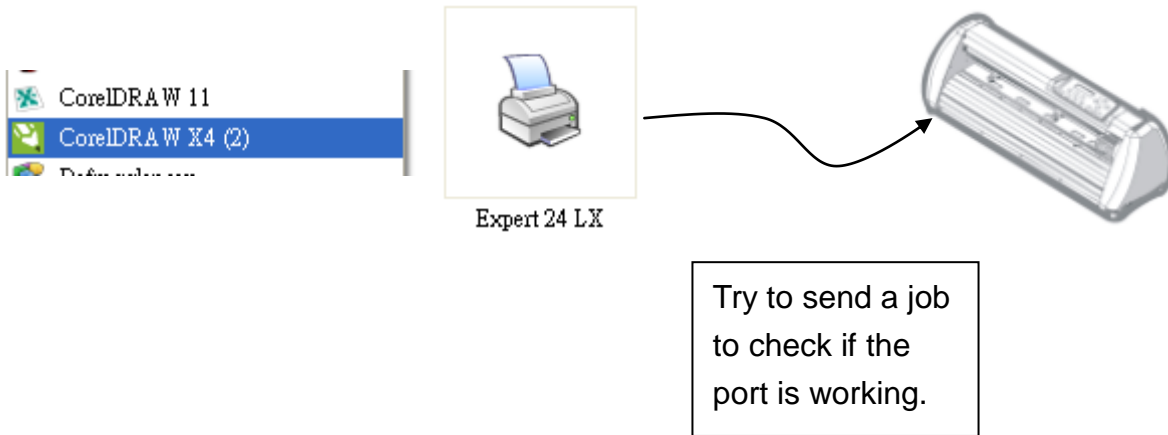

Step 4 Activate A-PC's Printer Driver from B-PC's Network.

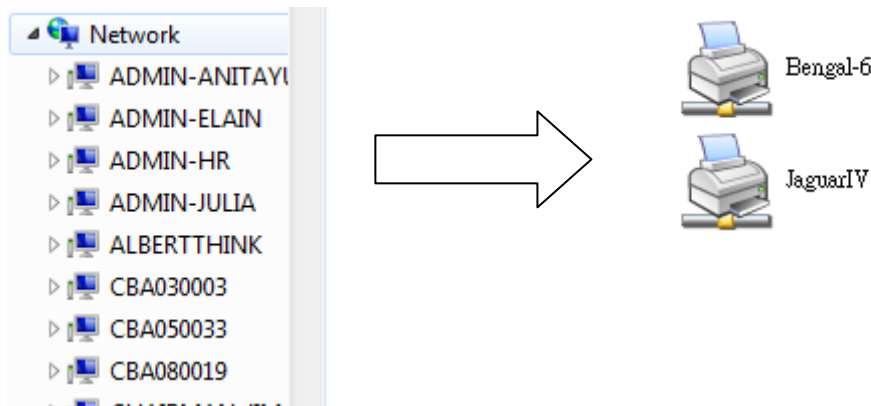

Step 5 Right-click on the printer icon, and select "Connect" to A-PC's printer.

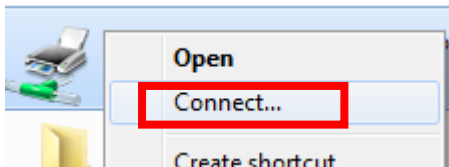

2.7 Software Installation

2.7.1 GreatCut Installation

Step 1 Click GreatCut Registration in installation DVD to go <http://gccvoucher.eurosystems.lu/>, and then enter your voucher code provided when purchasing GreatCut and click “Go on!”

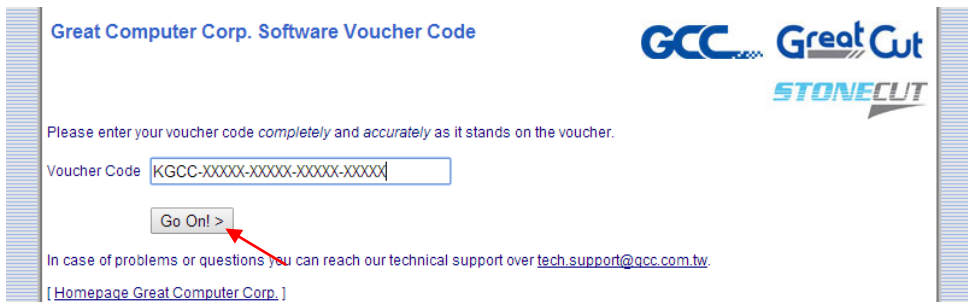

Step 2 Click “Request” to go to registration page.

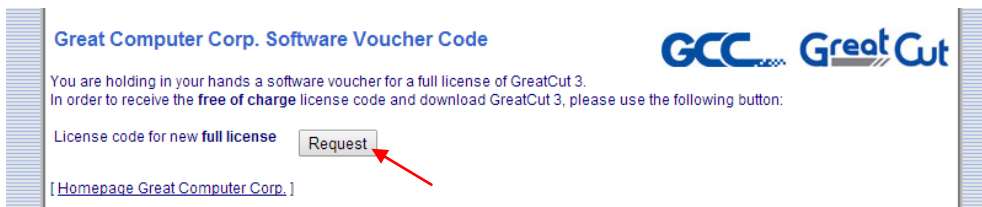

Step 3 Fill in the required information and click “Request license code.”

Software Download GreatCut 3

GreatCut
Software Registration

Last name, first name: Eileen Chen ! Required fields
Would you please use Latin resp. West-European characters!

Company: GCC

Street: 4F-1, No. 236, Fude 2nd Rd., Xizhi Dist. !

PO box: !

City: New Taipei City !

State/Prov.: (only US and Canada) !

Zip (postcode): 22151 !

Country: Taiwan !

Phone: 886266166692 !

Fax: !

eMail address: eileen.chen@gcc.com.tw !
Important: Pay attention to enter your eMail address correctly, because license code is sent to this address!

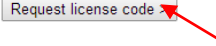

Step 4 The registration is completed; you should receive two emails, one is registration confirmation with activation link and another is your license data with **.ecf** file.

Registration Successful

Thank you, that you decided for GreatCut 3.

An email with further information for GreatCut 3 was sent to the given email address (eileen.chen@gcc.com.tw). Please be patient, as it may last up to 30 minutes until you can receive this email.

If you don't receive an email, please fill out the form on gccvoucher.eurosystems.lu again with a working email address.

[\[Home Great Computer Corp. \]](#)

Step 5 Check your email to see if you receive the activation link and click the link that will direct you the link for GreatCut download.

寄件者: tech.support@gcc.com.tw
收件者: eileen.chen@gcc.com.tw
副本:
主旨: GreatCut 3 - Activation Link

Dear Customer,

thank you, that you decided for GreatCut 3.
Please click the following activation link or enter it in your web browser:

<http://gccvoucher.eurosystems.lu/activate.dml?id=128461259209629vuLFO0aiKeRkh0gg> 

After clicking the link, you immediately will get download links and license data for GreatCut 3.

If you have questions, you can reach our support over tech.support@gcc.com.tw.

Best regards
Great Computer Corp.

Step 6 Or click “Install GreatCut” in installation DVD.



Step 7 Select a destination folder.

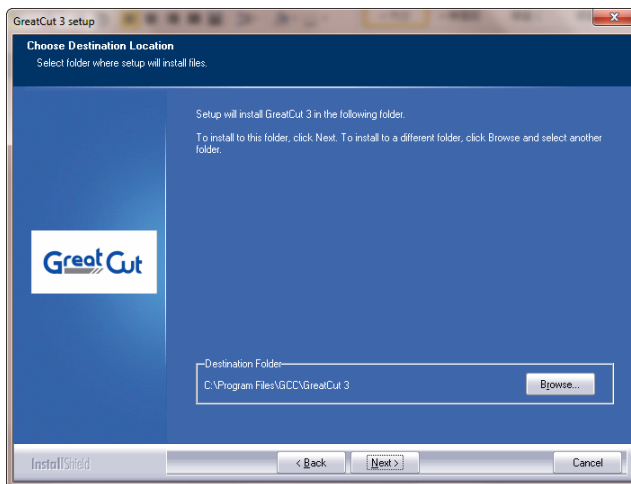

Step 8 Select Typical and click Next.

Note: You may select custom setup to install additional drivers.

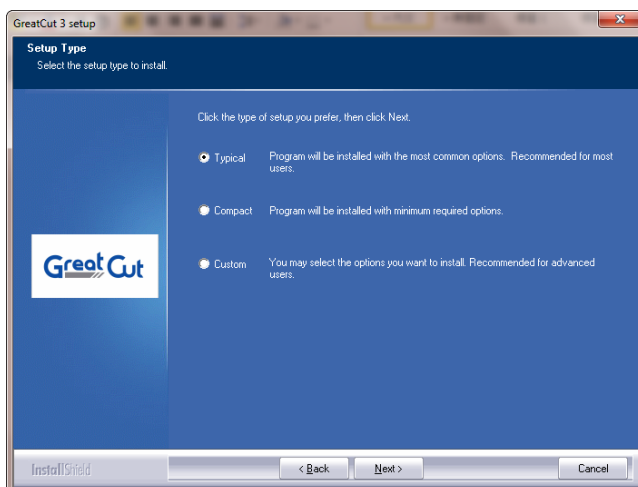

Step 9 Select the folder and click Next.

Default program folder in the start menu is GCC\GreatCut 3.

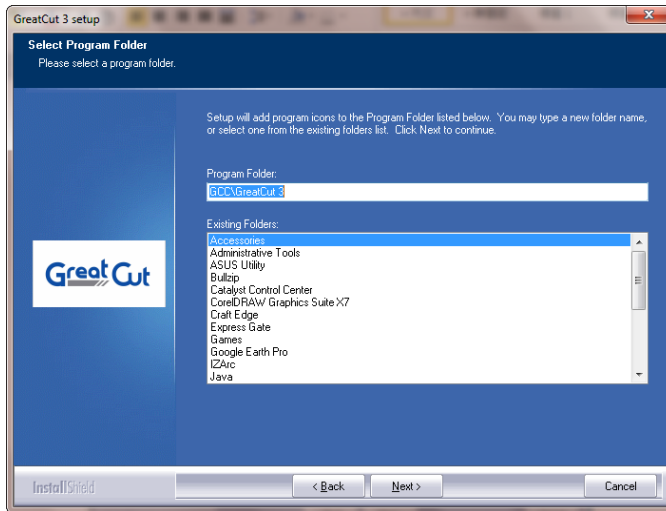
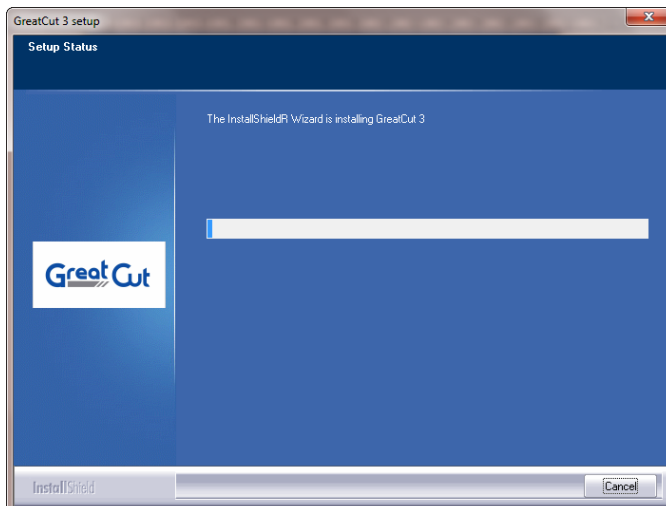
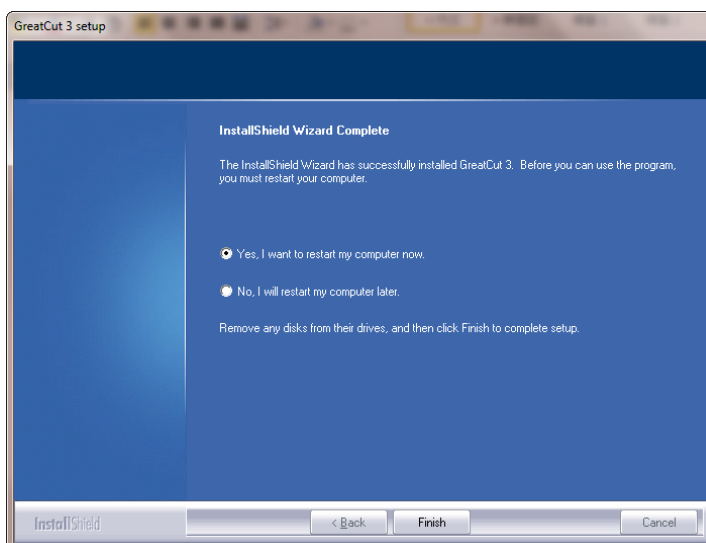
**Step 10** GreatCut is installing.**Step 11** Click Finish to complete installation.

Step 12 Before you launch GreatCut, open the **.ecf** attached to the license data email to install your license data to GreatCut so that you don't need to fill in your information again.

寄件者: RCS-ONLINE <directdownload@eurosystems.lu>
 收件者: eileen.chen@gcc.com.tw
 副本:
 主旨: GreatCut 3 - Receipt and License code

GC16P-1867.ecf (273 B)

GCC Great Cut

1. Please print this eMail.

2. License data for GreatCut 3

The following license code will be activated by copying or saving the attached file to the computer and starting it via double click. Thus the activation is done fully automatic and GreatCut 3 is ready to use.

For a possibly necessary manual input, here the license data (green) again in plain text:

Company / Name:	GCC
eMail:	eileen.chen@gcc.com.tw
Code:	GC16P-BMDL-BVAC-SJFC-VTWY-RHZS
Number of Licenses:	1
Serial No.:	GC16P-1867

Live Update:
 License installed successfully.
 OK

Step 13 If the license do not install successfully, you will need to fill in your license data manually. You can find the details of your license data from the email.

License data:

Note:
 Please fill out the fields of the license data exactly as you received it.

Company / name: [GCC]
 eMail: [eileen.chen@gcc.com.tw]
 Code: [GC16P-BMDL-BVAC-SJFC-VTWY-RHZS]
 System information PIN: [3666223328-0-9-1-57-MARKET-KEIRA2]

OK Cancel

寄件者: RCS-ONLINE <directdownload@eurosystems.lu> 寄件日期: 2015/2/25 (日)
 收件者: eileen.chen@gcc.com.tw
 副本:
 主旨: GreatCut 3 - Receipt and License code

GC16P-1867.ecf (273 B)

The following license code will be activated by copying or saving the attached file to the computer and starting it via double click. Thus the activation is done fully automatic and GreatCut 3 is ready to use.

For a possibly necessary manual input, here the license data (green) again in plain text:

Company / Name:	GCC
eMail:	eileen.chen@gcc.com.tw
Code:	GC16P-BMDL-BVAC-SJFC-VTWY-RHZS
Number of Licenses:	1
Serial No.:	GC16P-1867

Step 14 GreatCut is ready to use now.



2.7.2 Sure Cuts A Lot Installation (Optional Item)

2.7.2.1 Auto Installation

Step 1 Put your installation DVD into your CD-ROM to start the installation. The software is compatible with Windows 7 and above and Macintosh OSX 10.6 and above.

Step 2 Select “Install Sure Cuts A Lot” to start the installation.

Step 3 Press Next to continue.

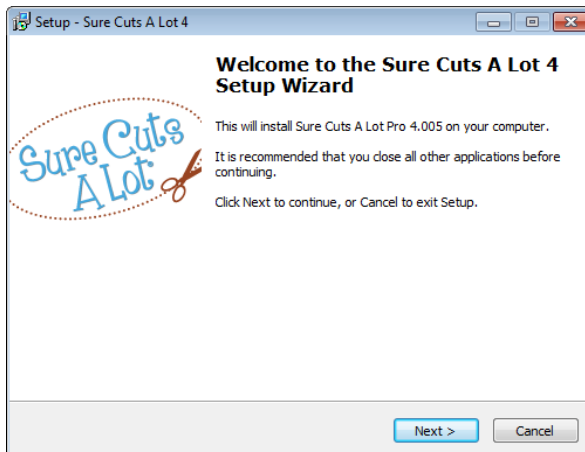

Step 4 Select “I accept the agreement” and press “Next.”

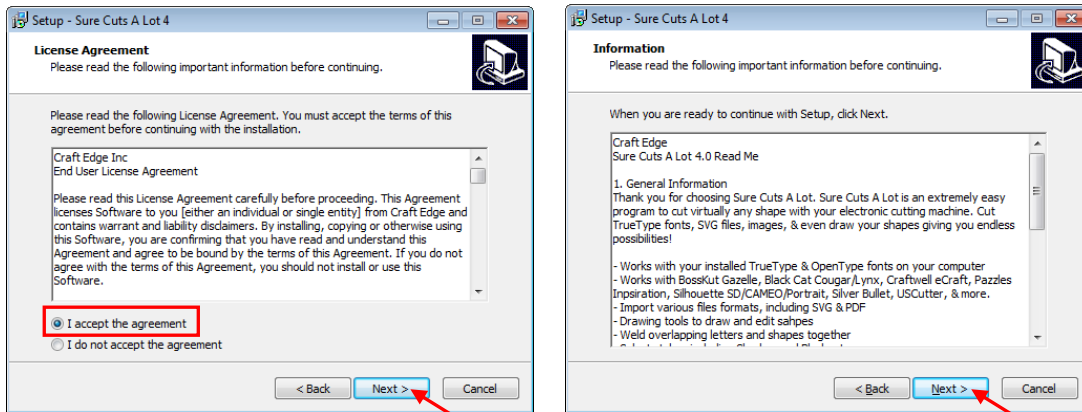

Step 5 Use the default folder (suggested) or select a folder you want to install the Sure Cuts A Lot and press “Next.”

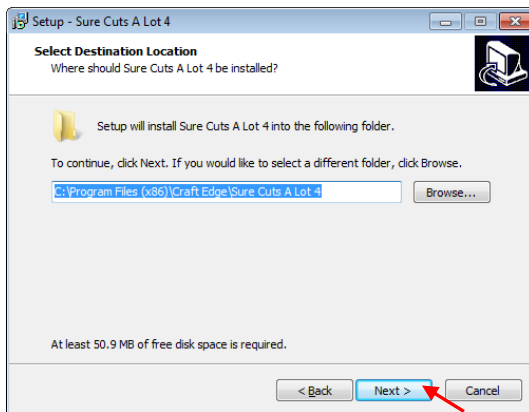

Step 6 Tick “Create a desktop icon” if you want to create a shortcut on your desktop, and tick “Associate scut4 extension” to associate the scut4 extension file with Sure Cuts A Lot software. Then press “Next” to start the installation.

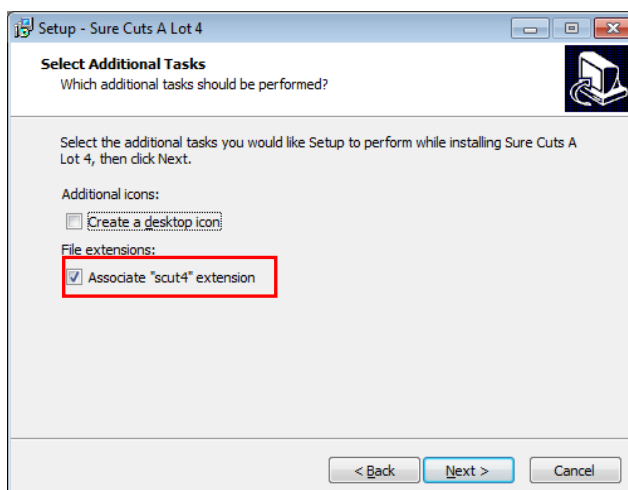

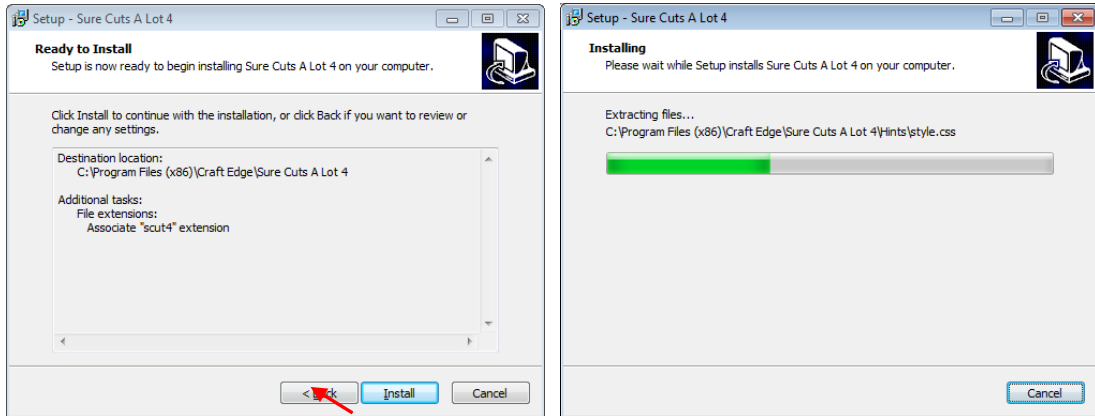

Step 7 Don't tick "Install USB Driver" and tick "Launch Sure Cuts A Lot," and then press "Finish" to complete installation.

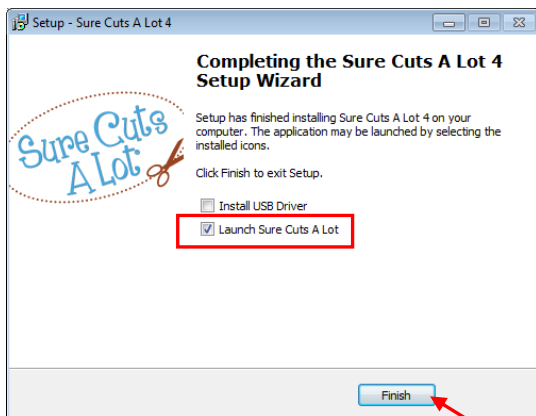

Step 8 Run Sure Cuts A Lot.



Step 9 Press "Activate..." to activate Sure Cuts A Lot. Please make sure it is connected to the internet.

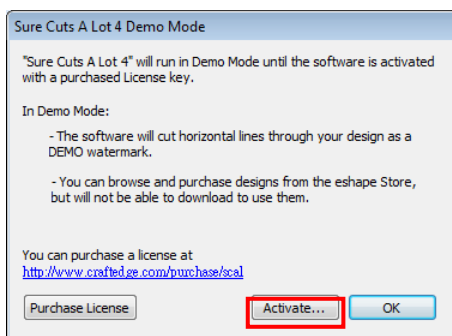

Step 10 Put your name in the Name column and enter the 25-letter software key shown on the DVD front cover to the Serial column and press “OK” to complete the activation.

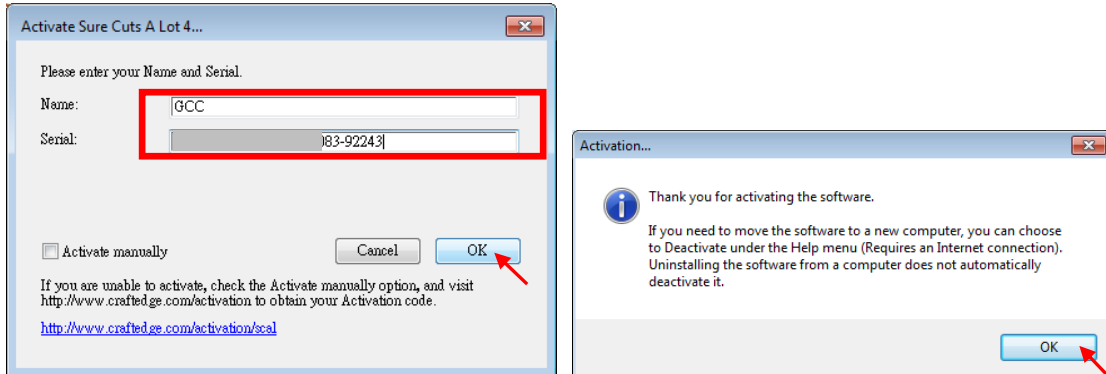

Step 11 Sure Cuts A Lot is ready to use.

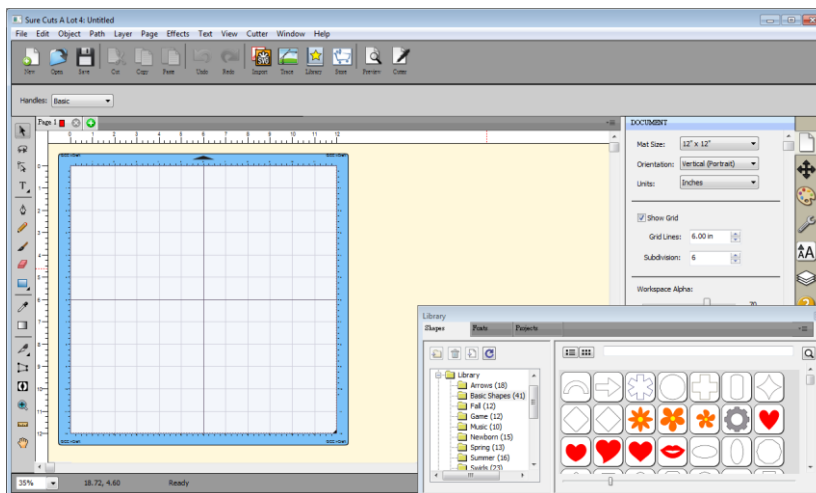

Note

- ✓ If you use a trial version to output graphics, meaning you do not enter the software key to activate the Sure Cuts A Lot mentioned above, there will be two extra lines cut through the design, therefore, make sure the Sure Cuts A Lot software is activated before implementing cutting jobs.

2.7.2.2 Manually Activate Software

If the computer connected to cutter doesn't have internet connection to accomplish above software activation process, you can use "Activate manually" function alternatively to enter the "Activation Code" to start the usage of Sure Cuts A Lot. Meanwhile, you need to find another computer that has internet access to obtain the "Activation Code" in advance following below instructions.

Step 1 Check the "Activate manually" checkbox and you should see the Site Code and Activation Code fields appear. The Site Code field will be pre-filled in and cannot be changed.

Activate Sure Cuts A Lot 4...

Please enter your Name, Serial and Activation Code.

Name: k

Serial: [blurred]

Site Code: 62920-43822-24190-41812

Activation Code: [empty]

Activate manually

Cancel OK

If you are unable to activate, check the Activate manually option, and visit <http://www.craftededge.com/activation> to obtain your Activation code.

<http://www.craftededge.com/activation/scal>

Step 2 Visit <http://www.craftededge.com/activation/surecutsalot> via an internet connected computer. Enter your name, serial (software key, shows on the DVD cover) and site code.

Step 3 Click on the "Generate Activation Code" button, and your activation code will be shown in the Activation Code field.

Activate "Sure Cuts A Lot"

Important: You only need to do the following if you are having trouble activating from within "Sure Cuts A Lot" or do not have an Internet connection on the computer you are trying to activate on.

You must activate in order to use the full version of the software. Generally, you will just need to choose Activate.. from the Help menu in Sure Cuts A Lot and enter your name and serial number. The software will try to activate automatically and you can disregard this web page. **Do not** use this web page if you have not installed the software yet or have not purchased.

If you view the About box in Sure Cuts A Lot and it shows your name and serial number, the software is activated ok.

If you have problems activating automatically, you must use this web page and generate an Activation Code. The Name and Serial information is obtained from your purchase confirmation e-mail. The Site Code is obtained by running the program and choosing "Activate.." and checking the "Activate Manually" option.

Name:
Please enter your full name

Serial:
Must enter with the dashes (example: 12345-12345-12345-12345-12345)

Site Code:

Step 4 Copy and paste the activation code back into the activation dialog box of Sure Cuts A Lot program and hit ok.

2.7.2.3 Re-install Sure Cuts A Lot Software

If you change a new computer, you may need to deactivate your Sure Cuts A Lot software and re-install it on your new device.

Go to "Deactivate..." under Help and press Yes to confirm, then follow the installation procedure and use **the same code** to activate it on another computer.

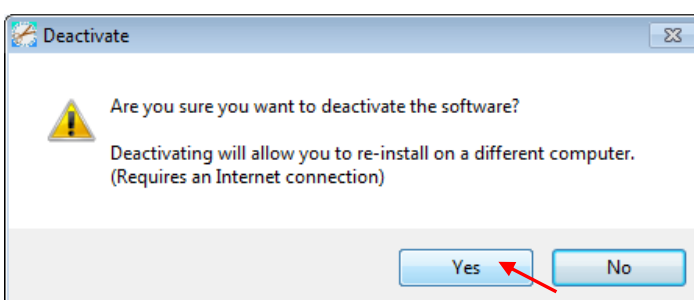
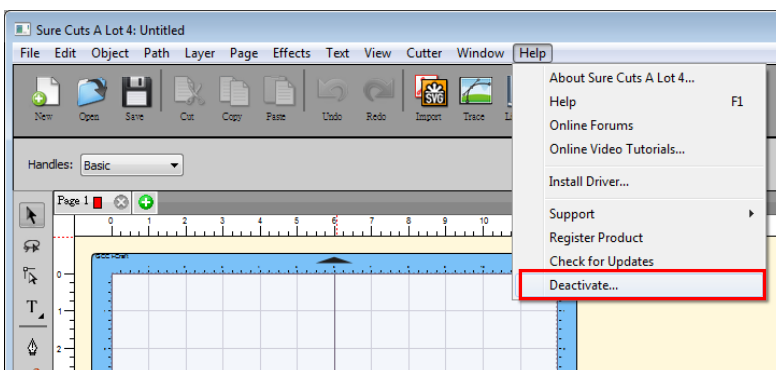

Chapter 3 The Control Panel

This chapter describes the button operations with the LCM menu flowcharts of Puma IV. When the cutting plotter is ready for use as described in Chapter 1 & 2, all functions are under default parameters.

3.1 The LCD Panel

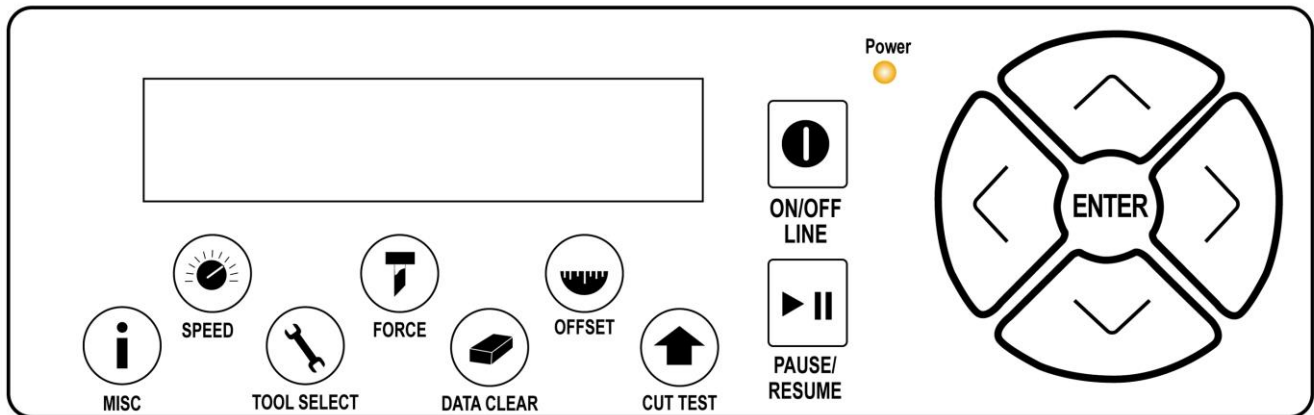

< LCD Control Panel on Puma IV series >

Key	Function
LCD Screen	To display functions and error messages.
Power LED	To indicate the power status (light up: power on; light off: power off)
4 Arrow Keys	To move position, select function, or change setting.
ENTER	To set item or register the immediately preceding input value.
PAUSE/RESUME	To temporarily halt cutting process or to continue
ON/OFF LINE	To switch modes, stop cutting job, or abort changes of settings.
OFFSET	To adjust the value of blade's offset.
FORCE	To adjust the value of cutting force.
SPEED	To adjust the value of cutting speed and quality.
CUT TEST	To perform cutting tests on different media
DATA CLEAR	To clear up buffer memory.
TOOL SELECT	To select tools.
MISC	To set up functions.

Please see details in ["3.4 Menu Items"](#)

3.2 Menu in On-line Mode

Power On Puma IV (LX) in processing

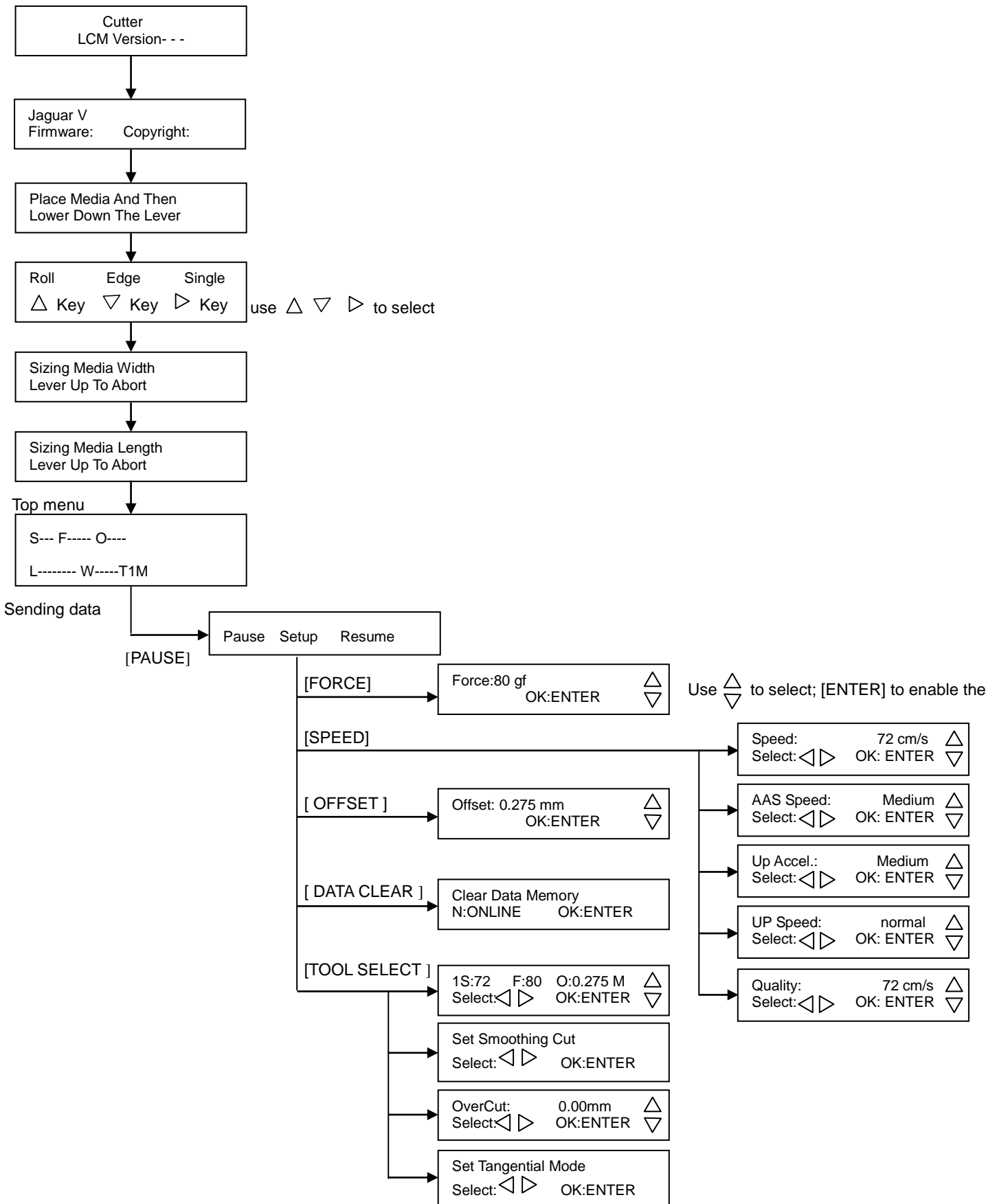

3.3 Menu in Off-line Mode

Press [ON/OFF LINE] to switch to the offline mode

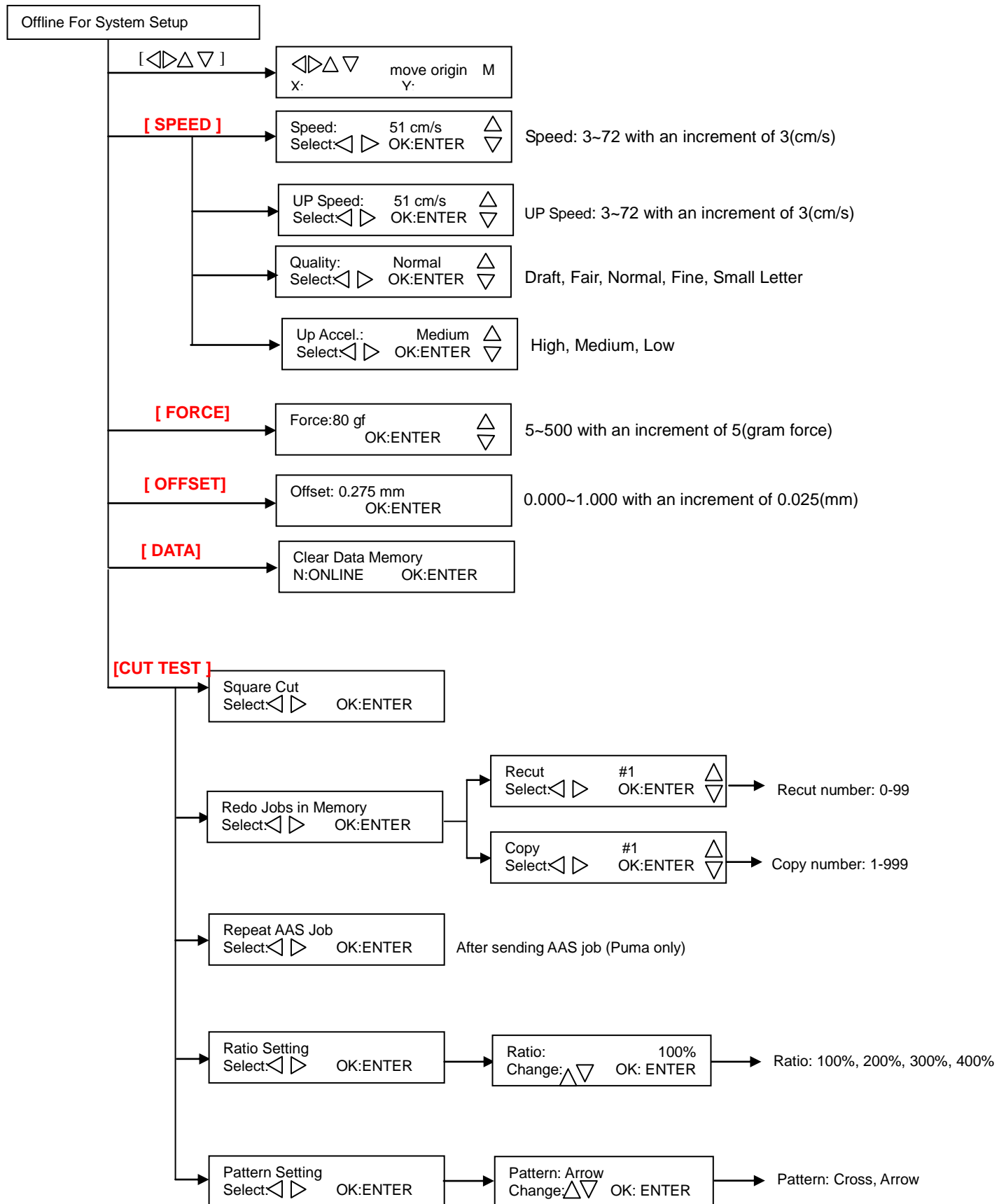

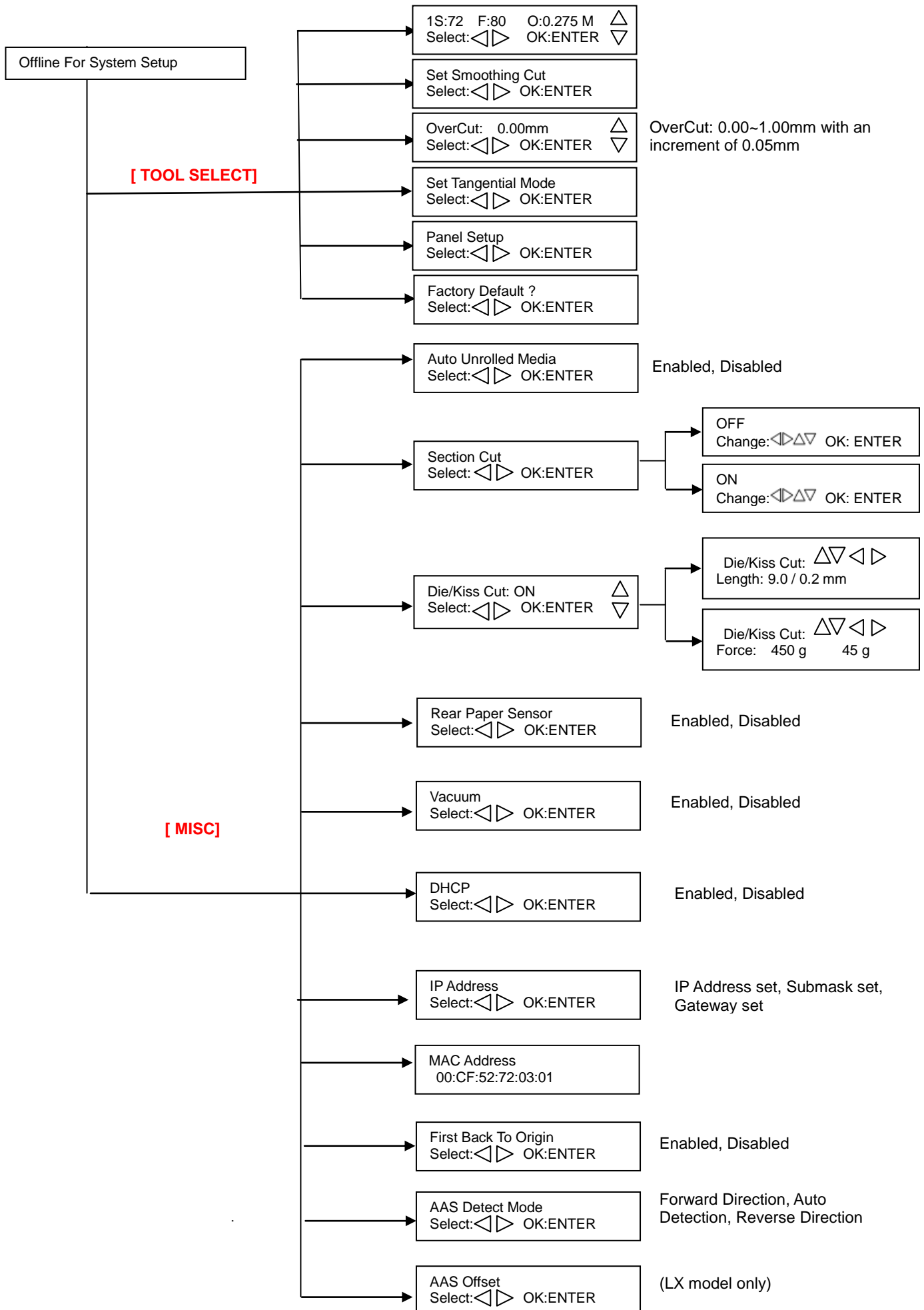

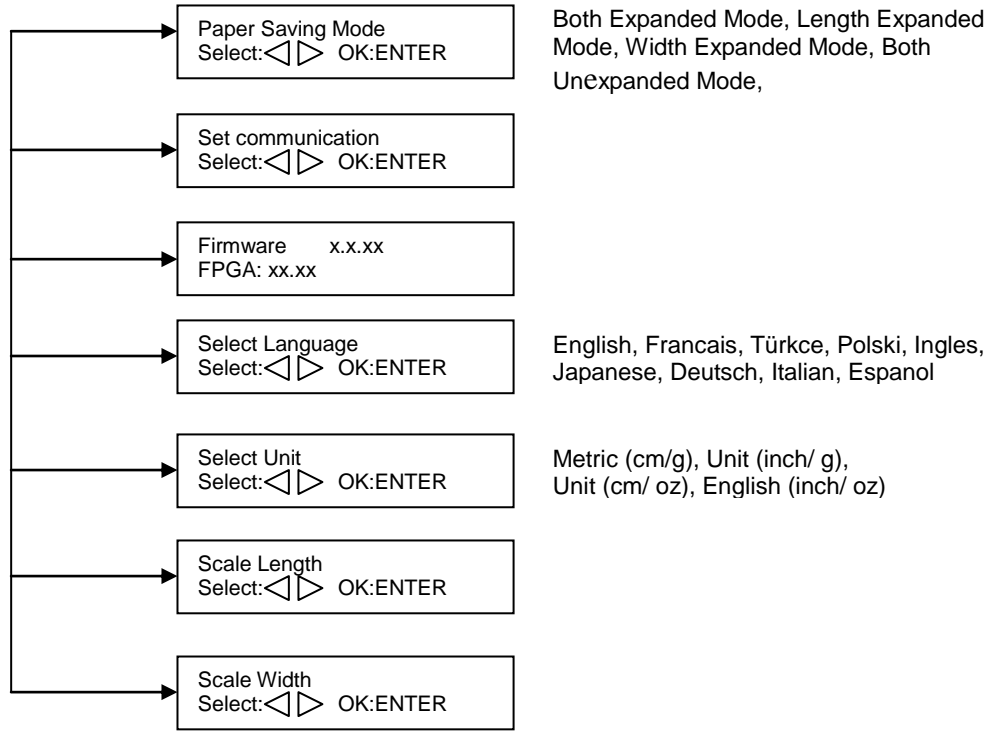

3.4 Menu Items

Below describes the functions of menu items

Menu or Key	Function	Setting	Default
--- Media sizing ---			
Roll	To measure media width.	Maximum Tracking 150 meters	
Edge	To measure media width and pull the media back till the front paper sensor open.	Maximum Tracking 150 meters	
Single	To measure media width and length.	Maximum Tracking 10 meters	
--- POWER ---			
	To indicate the power status.		
[Arrow Keys]			
	1. To move the tool carriage position on X or Y axis. 2. To select functions or change values of settings.		
[ENTER]			
	1. The displayed parameters will be saved automatically. 2. To set a new origin at the present tool carriage position. In "offline" mode, moving the tool carriage to desired position by [Arrow Keys], then press [ENTER] key to set a new origin. While moving with the parameters of XY-axes displayed, press [MISC] key will enable fine-tune movement; press [MISC] key again to disable the function.		
[PAUSE/RESUME]			
	To temporarily halt the cutting process. To resume the process by press [Pause/Resume] key again.		
[ONLINE/OFFLINE]			
	1. To switch between online mode and offline mode. 2. To stop the cutting job or abort the change of setting. Once press this key, the cutting job will be terminated immediately and cannot be resumed.		
[OFFSET]			
	To set or modify the distance between the blade tip and the center axis.	0.000~1.000mm	0.275mm
[FORCE]			
	To set or modify the value of tool force.	5~500gram; 5 gram/per step	80 gram
[SPEED]			
Speed	To set or modify tool speed at horizontal moving.	3~72 cm/sec; 3cm/sec per step	51cm/sec
Up Speed	To set or modify tool speed while the tool move from endpoint to next start point at horizontal moving.	3~72 cm/sec; 3cm/sec per step	51cm/sec
Quality	To set or modify cutting quality. [Slower speeds / higher quality - Faster speeds / lower quality] The Set Cutting Quality Page allows you to adjust and balance vector mode's quality and speed settings based on your specific job. Draft Mode offers the highest output speed, sacrificing quality. Whereas Quality Mode offers the highest quality, sacrificing output speed. Keep in mind that speed and quality are usually at a tradeoff.	Draft, Normal, Fair, Fine	Normal

Up Accel.	To set or modify tool acceleration levels while the tool move from endpoint to next start point at horizontal moving.	High, Medium, Low	Medium
[CUT TEST]			
Square Cut	To perform a cutting test at present blade position. For more information, please refer to “4.3 Adjusting the Cutting Force and Offset” to adjust blade force and cutting speed.		
Redo Jobs in Memory	To redo the cut test jobs saved in memory by recutting or producing cut test copies. Recut number: 0 means limitless. If you want to set number as 0, you should set that between repowering the cutter and putting down the lever.	Recut (number of jobs: 0-99) Copy (number of jobs: 1-999)	Recut
Repeat AAS Job	To repeat AAS jobs automatically without having to operate on the computer side. Please be noted that this feature is mainly applied to the Single paper mode; please ensure a new piece of material you wish to apply this feature on is loaded and the origin repositioned to the first registration mark before starting. When the first AAS job repeat completes, the user will be offered the choice of “Repeat AAS Job Again”, please press “Online/Offline” to return to the main menu. This option will appear after finishing reading all registration marks (Puma only).		
Ratio Setting	To adjust the size of the pattern	100%, 200%, 300%, 400%	100%
Pattern Setting	To provide two patterns for cut test Note: It is recommended to select “Cross” if you are working on thick pieces of materials.	“Arrow” and “Cross” patterns	“Arrow”
[DATA CLEAR]			
	To clear up buffer memory.		
[TOOL SELECT]			
Save Parameter	To save pattern(s) of cutting parameters for later use. There are 4 sets of parameters saved in the panel. Use Page Up and Page Down keys to select the set of parameters you wish to adjust, press “Enter” to confirm (the number shown on the upper left corner will change accordingly). Each set of parameters includes Speed, Force, Offset, Up Speed, Quality and Scaling though the latter three will not be displayed in this section. To adjust or check individual parameters, go back to the responding keys on the panel and press “Enter” to confirm.	Patterns1~4	Pattern 1
Set Smoothing Cut	To enable smooth-cutting function.		Enable
Over Cut	To generate an overcut to facilitate weeding.	0.00mm-1.00mm 0.05mm/per step	0.00mm
Set Tangential Mode	To enable the emulated tangential-cutting mode for thicker media types and small letter cuts. Note: while the Offset value setting at 0.000 mm, “Set Tangential Mode” will automatically be disabled.		Disable
Panel Setup	Accept setup command: To accept commands of the Force, Speed, Cutting Quality, and Offset only via software.		
	Control panel only: To accept commands of the Force, Speed, Cutting Quality, and Offset only via control panel of the cutter.		
Factory Default?	To turn all parameters of the menu items to factory-default settings.		

[MISC]			
Auto Unrolled Media	To avoid paper jam and motor crash by automatically unroll media (50cm and up) before cutting while enabled. . * Auto-unroll only effects on roll/edge media. * Using Single mode to size media will disable this function automatically. * If the length of the rolled media is less than 2 meters or the weight is light, it is recommended to set this mode disabled.		Enable
Section Cut	To divides the long plot data into sectional output jobs to gain higher cutting quality and increase precision. Users can set the section by registration marks or input the value manually.		200mm intervals
Die/Kiss Cut	To perform die cut/kiss cut in one cutting line simultaneously by designating the outline to green color RGB 255 and defining the length and force setting on control panel (Please refer to Chapter 4.9 for details).	Length: 0.2 ~9mm Force: 45 g~ 450 g	
Rear Paper Sensor	To detect if the rear paper sensor is covered to determine the following process; when it is enabled, the cutter will detect if the material has covered the rear paper sensor under the Roll and Edge mode; when disabled, the rear paper sensor will not be functioning. Note: Rear paper sensor only functions under “Roll” and “Edge” mode.	Enable Disable	Enable
Vacuum	To help improve tracking and cutting accuracy by turning on the fans. If you turn off the vacuum system, the fans will remain inactive during cutting or plotting.		Enable
First Back to Origin	To enable the carriage back to the previous origin; when “Enable” is selected, the carriage will not go back to the previous origin while the selection of “Disable” allows the carriage to do so.	Enable Disable	Enable
AAS Detect Mode	To recognize the printed sheet media is fed in forward direction or reversed direction by detecting the registration marks. 1. Forward direction: to detect the registration marks in forward media feeding direction 2. Auto detection: to distinguish the media feeding direction automatically by detecting the registration marks. 3. Reverse direction: to detect the registration marks in reversed media feeding direction		
DHCP	Shows your IP address for TCP/IP Configuration		Disable
IP Address	Shows the IP Address of your cutting plotter.		
MAC Address	Shows the MAC Address of your cutting plotter.		
AAS Offset	To set or modify AAS offset value. (Puma only) You can refer to “5.3 Printer Test” for more details.		
Paper Saving Mode	To save media by four different modes: 1. Length expanded mode 2. Width expanded mode 3. Both expanded mode 4. Both unexpanded mode		Length expanded mode
Set Communication	To build up the communication between host computer and cutter. <i>Baud Rate</i> is to determine the speed of data transmission. <i>Data Bits</i> refers to the size of one block of data. <i>Parity</i> is used to check if data was revived correctly or not. 9600, n, 7, 1, p 9600pbs, 7 Bits with NO Parity 9600, o, 7, 1, p 9600pbs, 7 Bits with ODD Parity 9600, e, 7, 1, p 9600pbs, 7 Bits with EVEN Parity 9600, n, 8, 1, p 9600pbs, 8 Bits with NO Parity 9600, o, 8, 1, p 9600pbs, 8 Bits with ODD Parity 9600, e, 8, 1, p 9600pbs, 8 Bits with EVEN Parity		

	19200, n, 7, 1, p 19200pbs, 7 Bits with NO Parity 19200, o, 7, 1, p 19200pbs, 7 Bits with ODD Parity 19200, e, 7, 1, p 19200pbs, 7 Bits with EVEN Parity 19200, n, 8, 1, p 19200pbs, 8 Bits with NO Parity 19200, o, 8, 1, p 19200pbs, 8 Bits with ODD Parity 19200, e, 8, 1, p 19200pbs, 8 Bits with EVEN Parity		
Firmware Version	To display the version number of Firmware and FPGA code.		
Select Language	To select displayed languages on LCM panel in English, Spanish, Italian, Deutsch, Japanese, Portuguese, Polish, Turkish or French.		English
Select Units	Provide four-unit systems for users convenient.	cm/s; inch/oz; cm/oz; inch/gram	Metric
Scale Length	Fixed scaling, for maintenance only.		
Scale Width			

Chapter 4 Operation

4.1 Media Loading

4.1.1 Loading the Sheet Media

To load the media properly, please follow the procedures listed below:

Pull the lever upward to raise the pinch rollers. (Figure 4-1)



Figure 4-1

Load your media on the platen and slide it under the pinch rollers from either the front side or the backside. The **alignment rulers** on the platen extension will help you to adjust the media precisely.

Note:

Be sure that the media must be covered by the paper sensors on the platen when loading the media. At least one of the two paper sensors should be covered. Once the media covers the sensor, the cutting plotter will size width and length of media automatically.

Then move the pinch rollers manually to the proper position. Be sure the pinch rollers must be positioned above the grid drum. The **white marks** on top trail will help you position pinch rollers when media on the platen. (Figure 4-2)

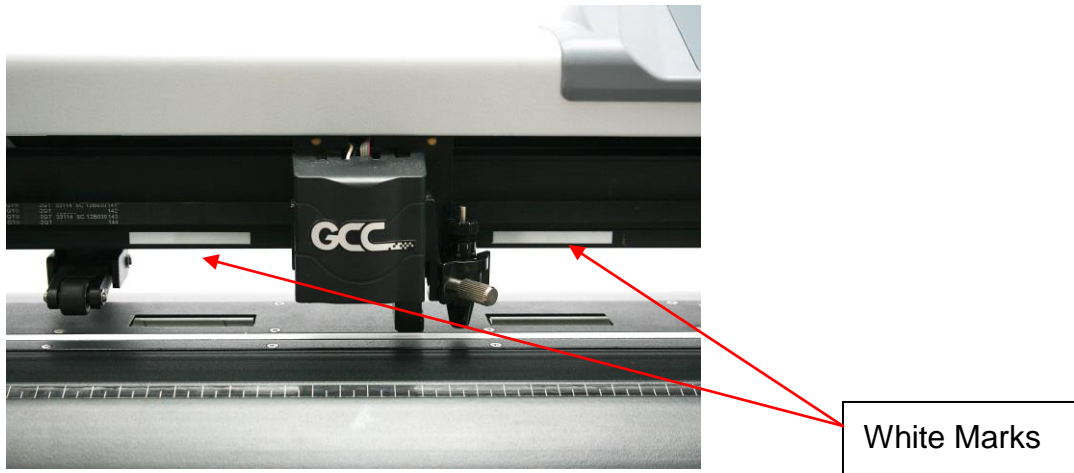

Figure 4-2

Push the lever downward to lower down the pinch rollers.

Turn on the power; the machine will be initialized. Then follow the instruction of LCM to measure the size of the media.

Note:

Move the pinch roller by applying force at the rear portion of the pinch roller support. Do not move it by holding its front rubber roller.



Figure 4-3 correct way to move pinch rollers

4.1.2 Loading the Roll Media

Step 1

Firstly, put the roll media guide bushes on two roll holders. (Figure 4-4)

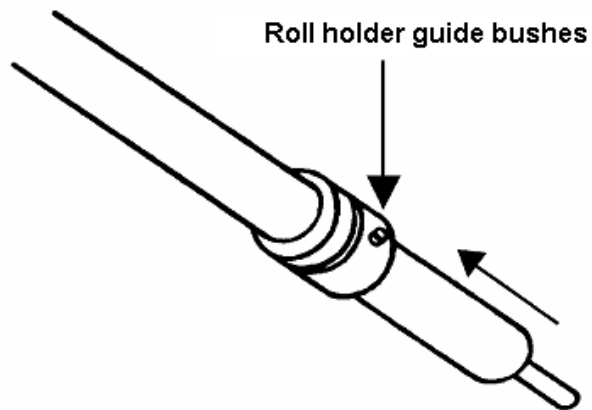

Figure 4-4

Step 2

Option A (Use the media flange)

Insert a roll media flange at the end of each roll media and tighten the thumbscrew until the roll media is firmly gripped. (Figure 4-5)

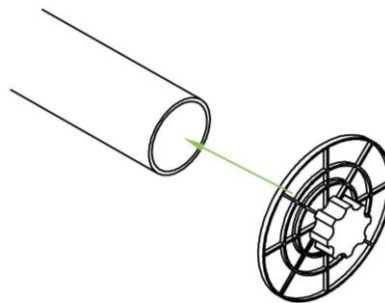

Figure 4-5

Then put the roll media on the roll holders. Adjust the position of the roll media ensure that the media flange is able to run in the groove of roll holder guide bushes. (Figure 4-6)



Figure 4-6

Option B

Insert the two roll holders into the roll media support set, and then place the roll media directly between the two roll holders. (Figure 4-7)

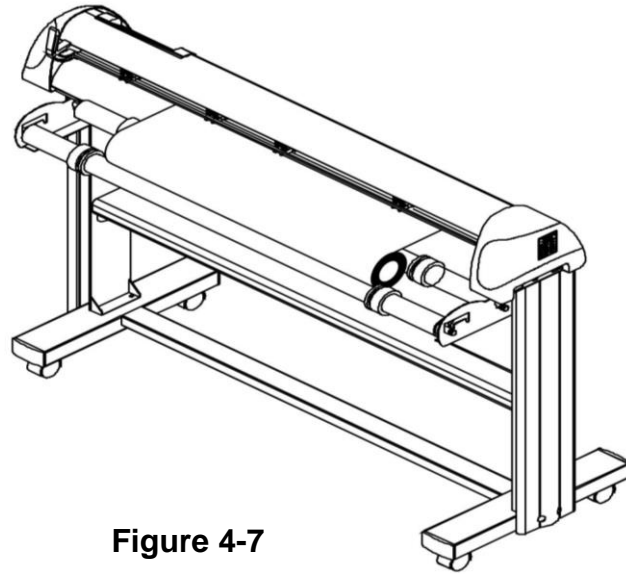

Figure 4-7

Step 3

Load the media on the platen. After loading the roll media, flatten the media on the platen and hold the front edge of the roll media firmly (Figure 4-8)

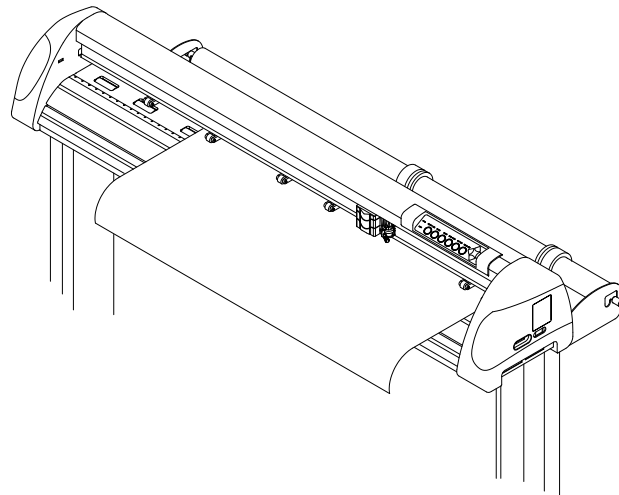

Figure 4-8

Step 4

Then turn the roll downward to make an equal tension across the media. (Figure 4-9)

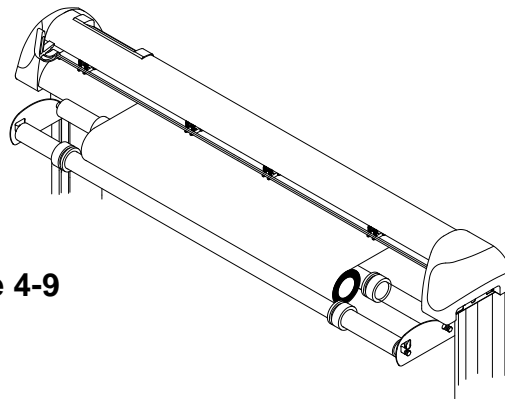

Figure 4-9

Step 5

Move the pinch rollers to the precise location and be careful that the pinch rollers must be positioned above the grid drums.

Step 6

Push the lever downward to lower down the pinch rollers.

Step 7

Fixes roll holder guide bushes on the roll holder to secure the roll media.

Step 8

Turn on the power switch and select Roll, Edge or Single mode appropriate for one time setup, or set to Default Roll in Sizing Setting and Roll type sizing will be performed when the machine is turned on. Then the cutting plotter is ready to work.

Step 9

Unloading media: Reversing steps mentioned above to remove the media.

For the users of Puma IV 60 LX / Puma IV 60, you can also use the “Roll Base” (a standard accessory of Puma IV 60 LX / Puma IV 60) to feed a roll media. Please adjust the position of roll base to get a good cutting result. (Figure 4-10)

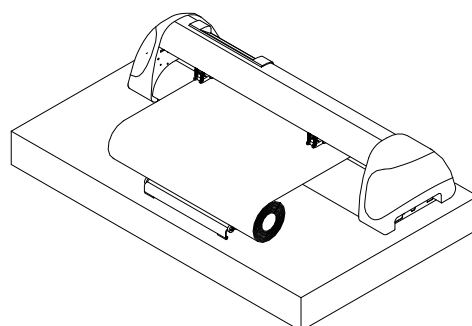
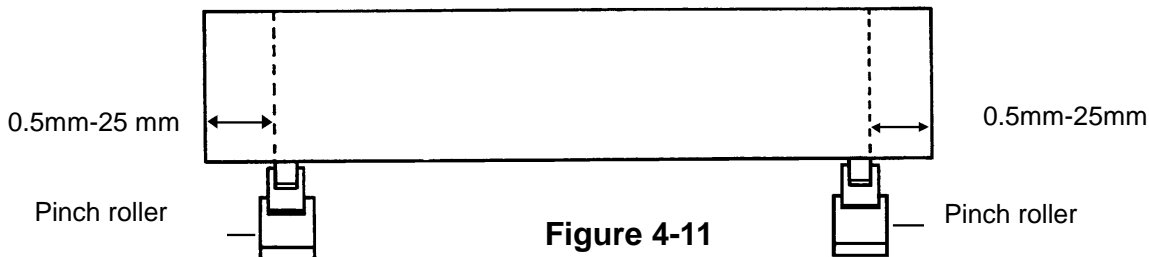

Figure 4-10

4.2 Tracking Performance

In order to achieve the best tracking performance for a long plot, please leave the margin of 0.5mm~25mm in the left and right edges of the media.(Figure 4-11)



4.3 Cutting Force and Offset Adjustment

Before sending your designs from computer to Puma IV for cutting, please make “Cut Test” to adjust cutting force and offset value.

The “Cut Test” should be repeated several times until the optimum settings are achieved.

Please follow procedure below to optimum the cutting force and offset settings.

Step 1

After sizing the media, press [CUT TEST] button to select the “Square Cut”, and press [ENTER KEY] to confirm.

The default cutting force and offset value of the cutting test are 80gf and 0.275mm respectively.

Step 2

Press [ARROW KEY] to move the tool carriage to the position where you would like to cut. Then, press the [ENTER KEY] to make a “Cut Test”.

Note: At the same time, the new origin is also set at the cut test position.

Step 3

When the “Cut Test” is completed, a pattern appears (please refer to Figure 4-12). Peel off the pattern to see if it can be easily separated from the media base. If the output result is good, the cutting force is set appropriately. If not or it cut through the back paper of media, press [FORCE KEY] to adjust the tool force until an optimum force is obtained.

Step 4

If the pattern appears to be BB or CC layout (see Figure 4-12), press [OFFSET KEY] to adjust the offset value until AA pattern is shown.

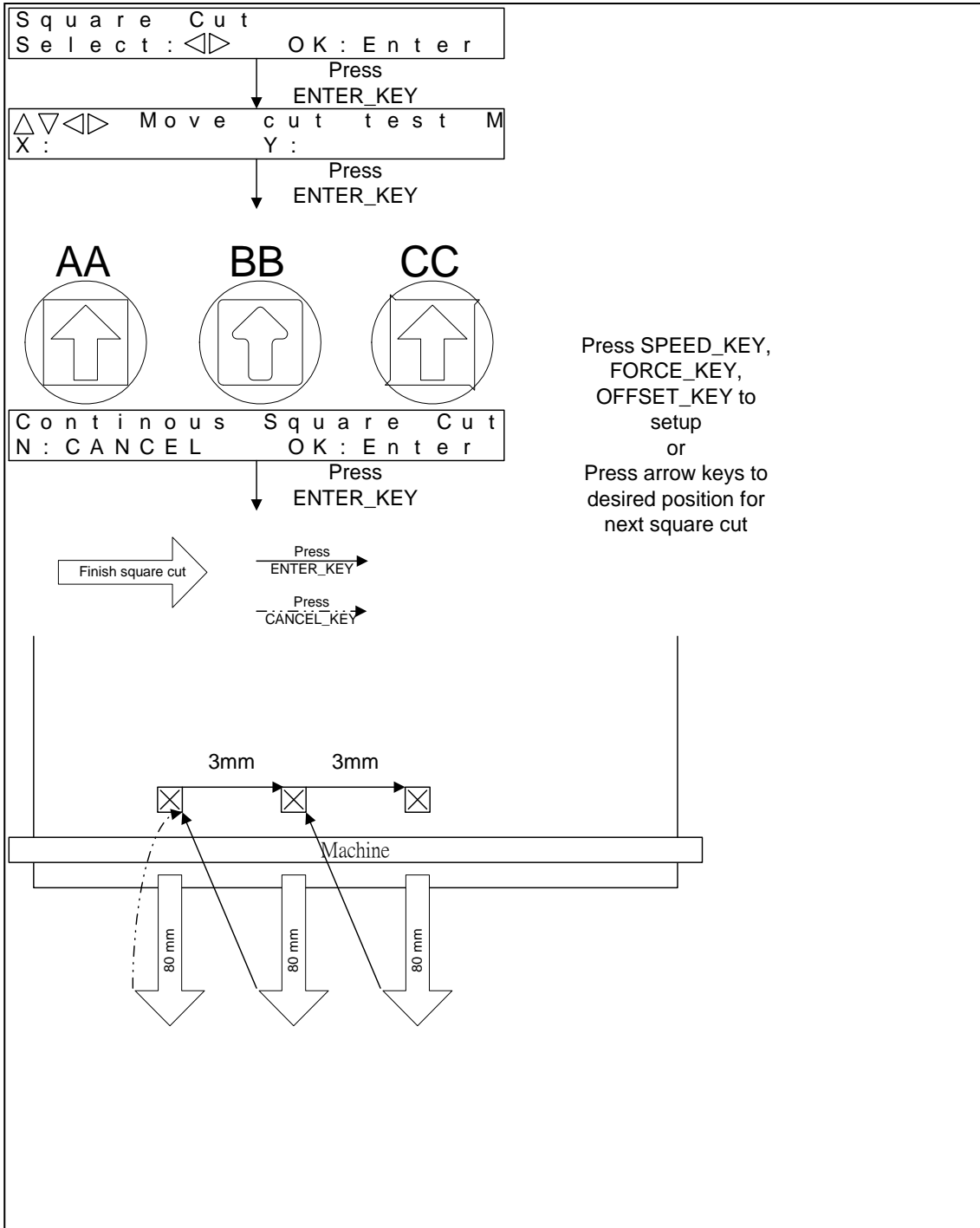

Figure 4-12

4.4 When Completing the Cutting Job

After completing the cutting job, raise the sheet-loading lever, and then remove the material. You can also cut off the finished job by the Safe Blade (a standard accessory) along the knife guide. (Figure 4-13)



Figure 4-13

4.5 Puma IV Print Driver setting

4.5.1 Puma IV Print Driver setting > Option Page

Setting: You can adjust the following settings, depending on your application or results you would like to achieve.

Quality:

[Small Letter / Fine / Normal / Fair / Draft]

The Cutting Quality setting function allows you to adjust and balance vector mode's quality and speed settings based on your specific job. Draft Mode offers the highest output speed, sacrificing quality. Whereas Small letter Mode offers the highest quality, sacrificing output speed. Keep in mind that speed and quality are usually at a tradeoff.

Use Plotter Setting:

The parameter settings will be set according to those set from the control panel.

Back to home:

The carriage will return to the original position when this option is selected.

Section Cutting:

Users can output long picture by section cutting which could make cutting more stable and get superior cutting quality. Users can set the section by registration marks or input the value manually. When cutting plotter finishing cutting in section 1, it will continue to cut in section 2.

The picture is shown as below:

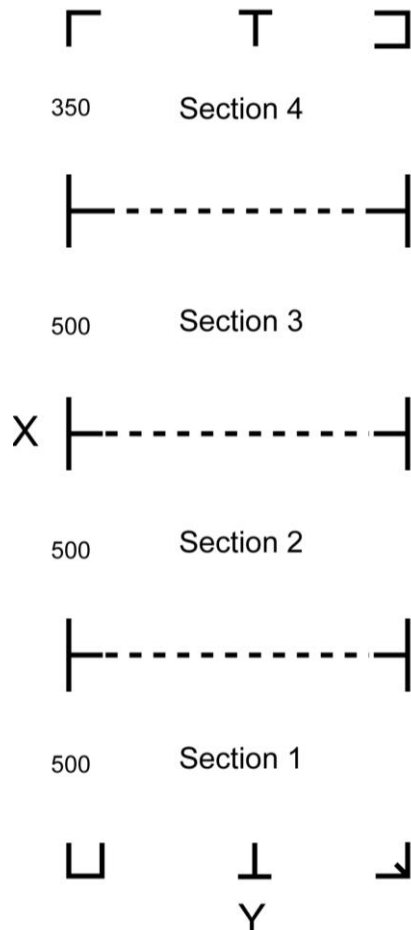

File Function:

The file function section allows users to set the parameters of Speed, Force, Offset and Quality for later use. This section is useful when performing repeated jobs on a variety of objects, allowing you to save your frequently used cutter parameters and load them in the future.

- **Save:** This function will save current print driver parameter settings to a file under the specified location on your computer. (Saved parameter setting files will be tagged with the Puma series extension)
- **Load:** This function allows you to load previously saved print driver parameters.
- **Original:** This function will load the print driver's original factory parameter settings.

- **Save To Default:** This function allows you to save your current print driver parameters as the default startup settings.
- **Delete:** This function will delete the file you select from the Custom Media section, whereas the settings in Default section cannot be deleted. Please note the delete function only removes the list shown in Custom Media section, it does not remove the file from your hard drive, if you wish to completely remove the file from your hard disk, you will have to manually delete the file from your operating system.
- **Custom Media:** This section lists the files for the parameter settings that you have recently created and worked. You can save more than 50 files to simplify your cutting job.
- **Default:** This section contains the reference settings that are applicable with the verified materials to achieve the best cutting results. Please note that the setting value might need to be adjusted according to different suppliers of materials.

Die Cut:

The Die Cut function must be activated with the Kiss Cut function to avoid the falling of cut-through materials and material jam beneath the carriage. Die Cut helps you to cut through the backing of the material while Kiss Cut cuts through only the top layer but not the backing. This will leave only tiny bits of the backing attached to the top layer, creating complete individual patterns with backing sheets (see figure 1 and 2).

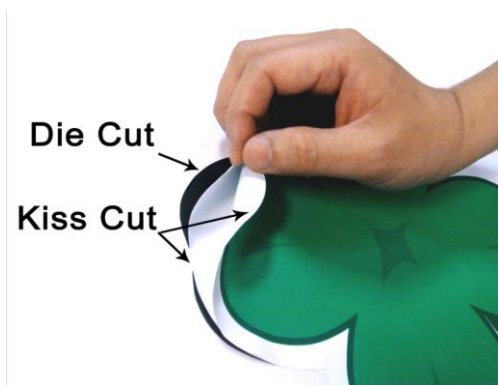
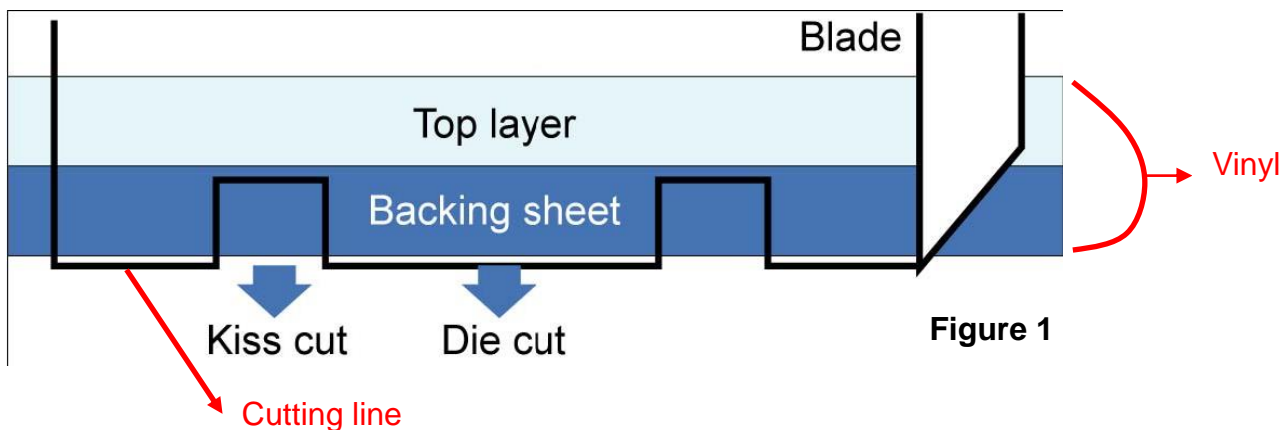

To activate the Die Cut function, go to “Option”, tick “Die Cut”, and enter the amount you wish for the “Length” and “Force” of both Die Cut and Kiss Cut, then click “OK” (see figure 3).

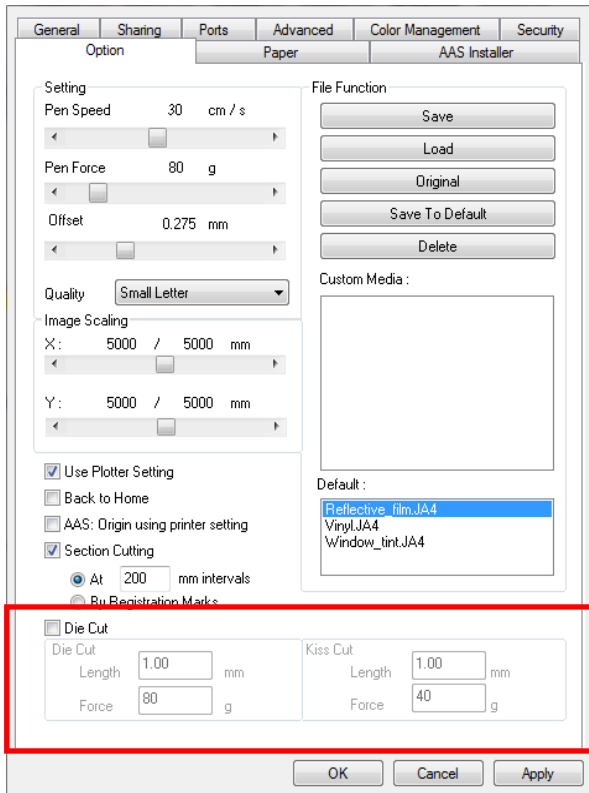

Note:

The length setting for the cutting line of Die Cut is in the range of 0-2000mm whereas that of Kiss Cut is 0-100mm.

Figure 3

When the job is completed and you untick the Die Cut function, you will be able to adjust the pen speed, pen force, and offset in the section on the top following normal operating procedures (see figure 4).

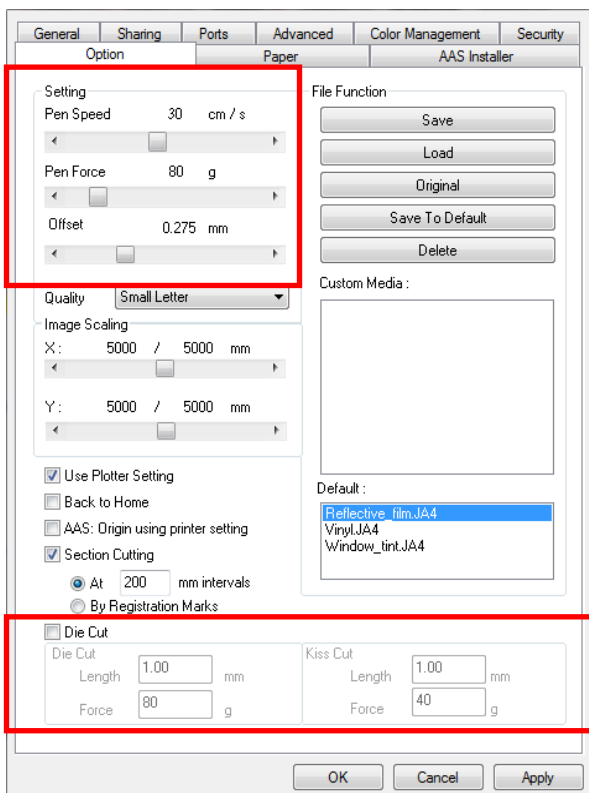

Note:

the extension of the blade has to be set to cut through both the top layer and the backing in the very beginning. You then adjust the tool force for the best cutting performance.

Figure 4

4.5.2 Puma IV Print Driver setting > Paper Page

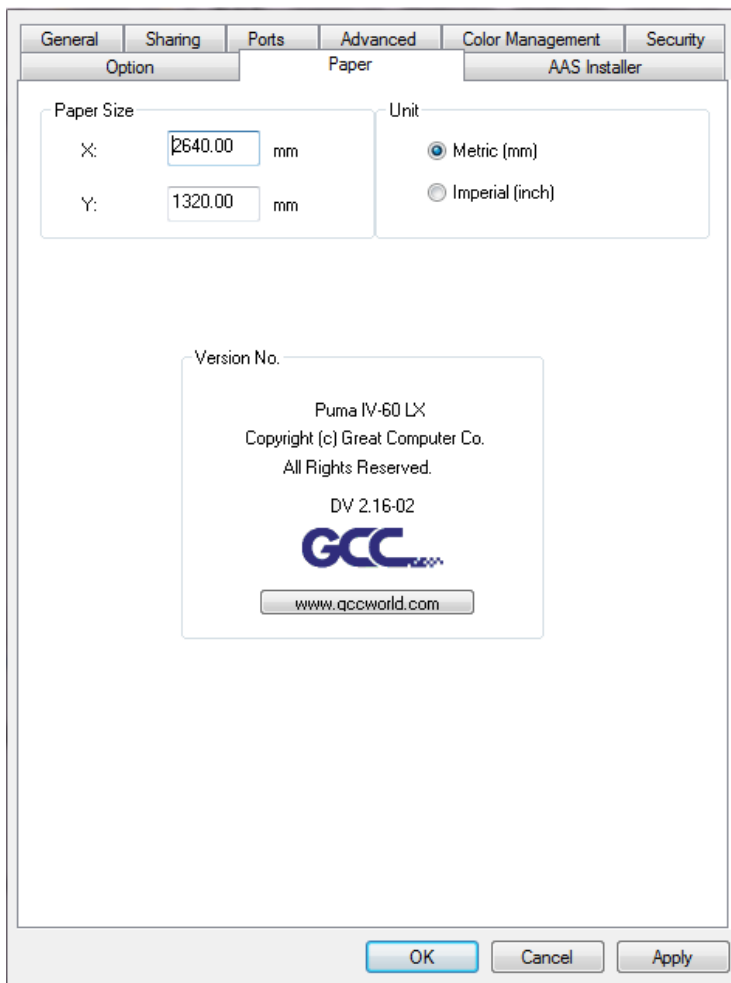

Paper Size (Paper Page) [DEFAULT SETTING: Y = the width of machine; X will be automatically set to be twice the length of Y]

The paper size represents your total work area. The X value represents the length and the Y value represents the width. The paper size should be set as the same as your image so you can get a better cutting quality.

Unit (Paper Page) [DEFAULT SETTING: Metric (mm)]

Here you can set your preferred measurement standard in which you would like use with the Jaguar V print driver. You can choose between metric or imperial standards.

4.6 Reference Parameter setting for different materials

The following reference parameter is used on GCC verified materials shown in the table.

Material	Personalized/ Wall stickers	Vehicle stickers	Window decoration	Window tint
Blade	red	red	red	red / yellow
Blade tip length (mm)	0.28	0.27	0.25	0.09
Force (g)	105	85	95	70
Speed (cm/sec)	72	60	65	72
Offset (mm)	0.25	0.25	0.25	0.25
Recommend model	RX, Jaguar, Puma, EX, AR	RX, Jaguar, Puma, EX, AR	RX, Jaguar, Puma, EX, AR	RX, Jaguar, Puma, EX, AR
Material	Stencil	Reflective film	Flock	Cardboard
Blade	red / green	green	green	green
Blade tip length (mm)	0.3	0.5	0.3	0.3
Force (g)	180	380	135	165
Speed (cm/sec)	15	3	30	30
Offset (mm)	0.25 / 0.5	0.5	0.5	0.5
Recommend model	RX, Jaguar, Puma, EX, AR	RX, Jaguar, Puma, EX	RX, Jaguar, Puma, EX, AR	RX, Jaguar, Puma, EX, AR
Material	Magnets	Protective tint	Rhinestone	Sandblast mask
Blade	green	green	green	blue
Blade tip length (mm)	0.8	0.3	0.8	0.27
Force (g)	580	320	190	85
Speed (cm/sec)	3	3	15	60
Offset (mm)	0.5	0.5	0.5	0.25
Recommend model	RX, Jaguar	RX, Jaguar, Puma, EX	RX, Jaguar, Puma	RX, Jaguar, Puma, EX, AR
Material	Small text (vinyl)			
Blade	black			
Blade tip length (mm)	0.27			
Force (g)	thick: 150 thin: 90			
Speed (cm/sec)	9			
Offset (mm)	0.175			
Recommend model	RX, Jaguar, Puma			

4.7 How to set die/kiss cut through plug-in software for Adobe Illustrator and CorelDraw

Die/kiss cut function allows you to define two cutting parameter in one cutting line, you can set through plug-in software for Adobe Illustrator and CorelDraw directly instead driver setting by designate the line to green color RGB 255 and then set the length and force from the control panel.

1. Select an outline that you want to do die/kiss cut in working area.

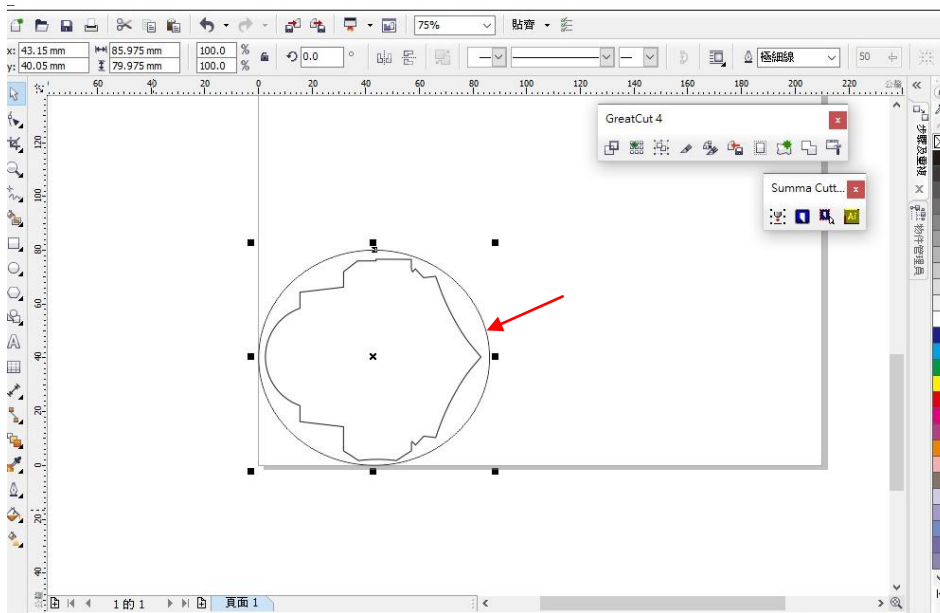

Figure 4-27

2. Change the color to **green color code RGB 255** then click “OK”
(Note: Only green color code RGB 255 is identified as die/kiss cut function, please don't select other color otherwise the function cannot work)

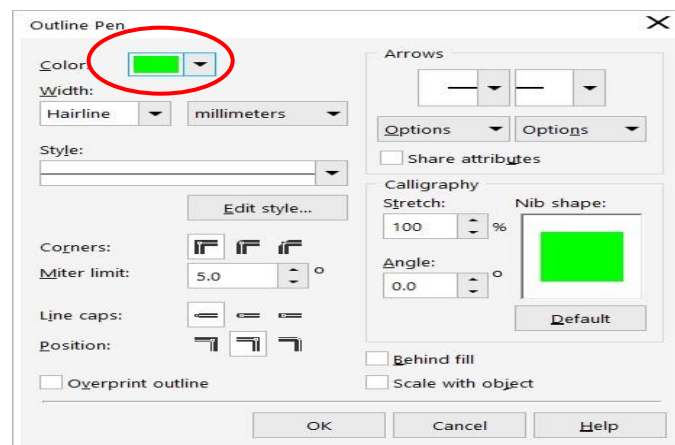

Figure 4-28

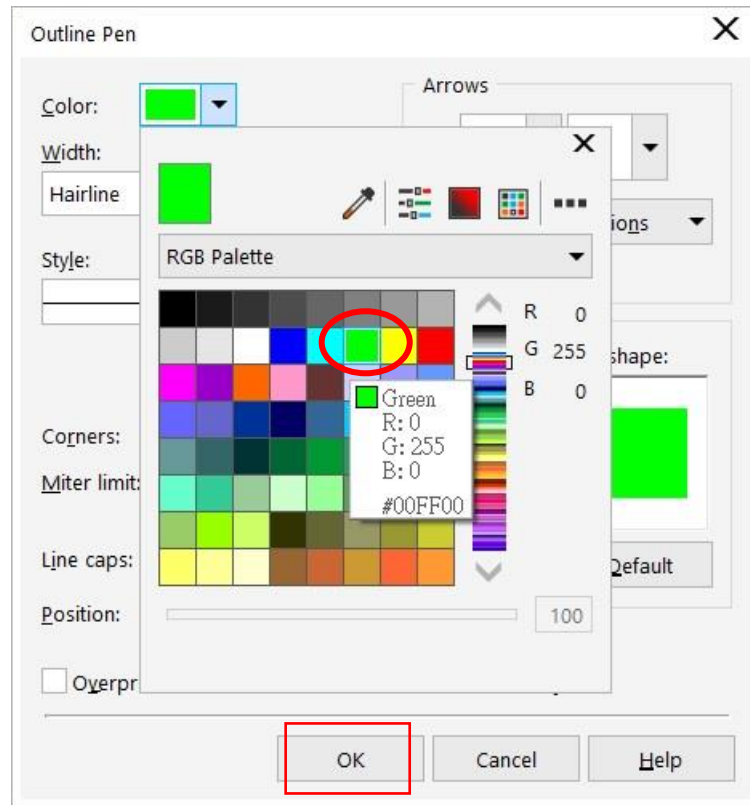

Figure 4-29

3. Outline color has been changed to Green.

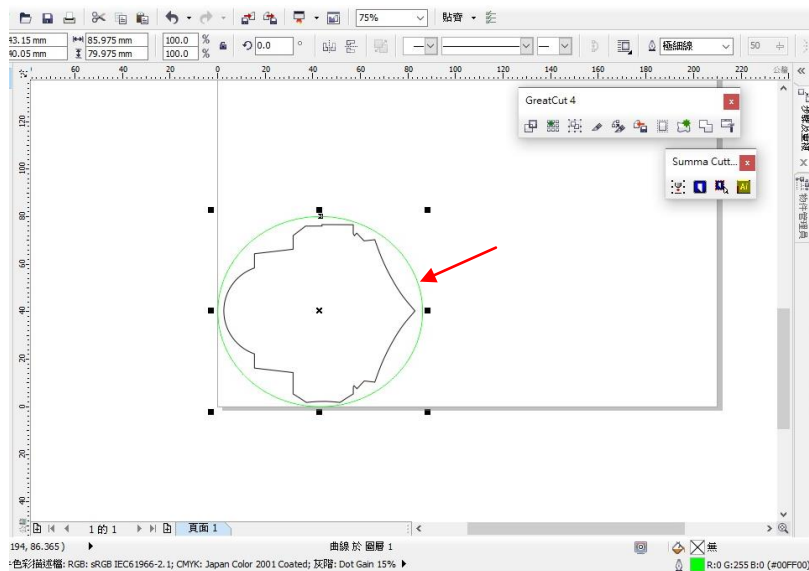
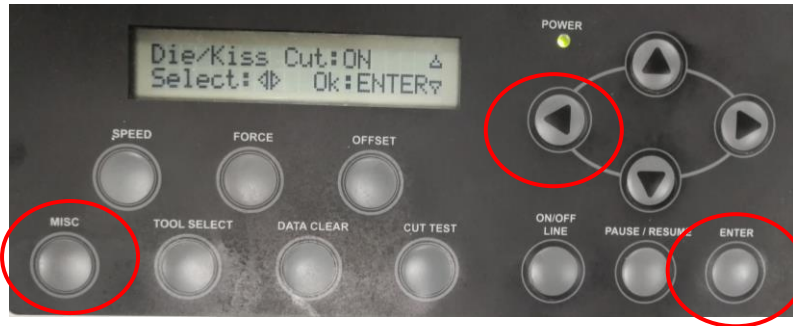
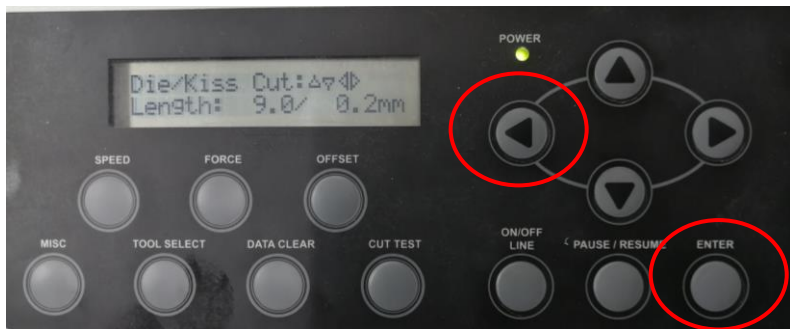

Figure 4-30

4. Select “ On/Off Line” > “MISC”, use arrow key to select “Die/Kiss Cut” function then press “Enter”.



5. Click the left arrow key to the next page to adjust the length value (0.2mm ~ 9.0mm) then click "ENTER".



6. Click the left arrow key to the next page to adjust the force value (45g ~ 450g) then click "ENTER" and finish the setting.



Chapter 5 Automatic-Aligning System

Please note that this chapter is only an instruction to AASII. **Puma IV LX models** feature AAS function, but **Puma IV models** don't. If you are **Puma IV models** user, please skip this chapter. For step-by-step instructions, please refer to the following chapters: A-4 CorelDRAW Plug-In, A-5 Illustrator Plug-In, A-6 GreatCut Plug-In.

5.1 Introduction

The Puma IV LX models cutting plotters feature a standard Automatic-Aligning System (AAS II) to guarantee precise contour cutting quality by detecting the registration marks printed around the graphic.

Notice

- Avoid any kind of light source horizontally illuminating the AAS module.

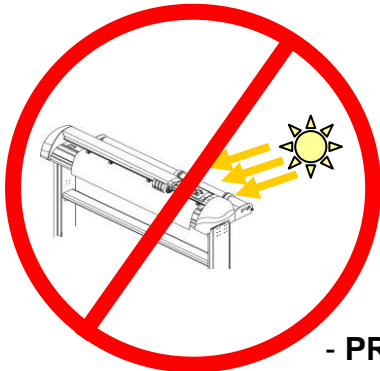

- PROHIBITED

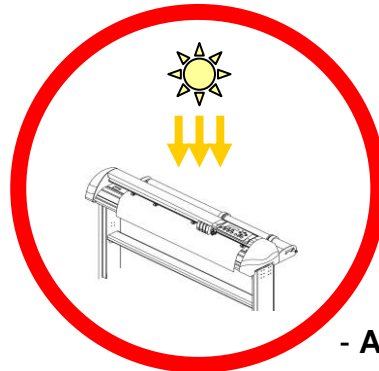

- ACCEPTABLE

- DO NOT take off the cover of AAS module while in operation.



- PROHIBITED

5.2 AAS Calibrating the System

The AAS system has one calibration procedures to ensure maximum accuracy of AAS operation. To operate the AAS you need to learn about the method of media feeding firstly. (Refer to 4.1 Media Loading.)

5.2.1 Media Calibration

Media Calibration is to ensure the sensor being able to recognize the registration marks. The factory default works on a wide range of materials. However, certain types of materials may not work properly. Performing a media calibration may become necessary while working with such materials to change the sensitivity of AAS for greater reliability. Media calibration adjusts the media feeding according to media type for better accuracy during cutting.

■ When to use

We suggest white media for best cutting result. It is not necessary to perform media calibration every time unless the registration marks on the printed media become undetectable in AAS sensing process.

5.2.2 AAS Calibration

The first registration mark is designed to be different in order to identify the origin for AAS auto-detection. The following precaution must be aware for registration marks to be read automatically.

- Type of media
- Registration mark pattern
- Reading range required for detection the registration marks
- Position for registration marks and medium

The registration marks have to be:

- Created by cutting software like SignPal or GCC CoreIDRAW plug-in
- In black color (printing quality of registration marks is essential; incorrect, misaligned colors, blurry or smeared printout might leading to inaccurate cutting result)
- Length: The length of marks
 - Range: 5mm~50mm
 - Optimized Setting: 25mm
- Thickness: The line thickness of marks
 - Range: 1mm~2mm
 - Optimized Setting: 1mm

- Margin: The distance between marks and images
 - Range: 0mm~50mm
 - Optimized Setting: 5mm

The cutter can not detect the marks while:

- Cutter carriage is not located near the outside area of first mark before detecting (See the picture in page 5-7 for auto-detecting area of first mark.)
- Medium thickness is more than 0.8mm
- Transparent medium is used
- Non-monochrome drawing. The marks can't be read if is printed on colored medium
- Dirty or creased medium surface

5.2.3 AAS II on Puma IV LX

There are three types of AAS II mark patterns: 4-Point Positioning, Segmental Positioning, and Multiple Copies. Note that before print out your designs by inkjet printers, the registration marks have to be created on your graphic designs by cutting software like SignPal, EasySign or GCC CorelDraw plug-in. Hand-made marks or drawings won't be reorganized by GCC cutting plotters. For more details about registration mark setting in cutting software, please refer to **Appendix A-4 CorelDraw Plug-In, A-5 Illustrator Plug-In, A-6 GreatCut Plug-In.**

1. 4-Point Positioning

This is the basic mark pattern that AAS II will auto detect four registration marks and contour cut images inside those marks.

- Command: Esc.D1;(XDist);(YDist):
- Layout: 4 registration marks at the 4 corners around the design

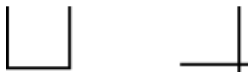

2. Segmental Positioning

In addition to 4 original points, the intermediate registration marks are added on both X axis and Y axis to help contour cut accurately, especially for cutting large images.

- **Command:** Esc.D2;(XDist);(YDist);(XStep);(YStep):
- **Layout:**

In-between distance on X: 200~600mm, default 300mm

In-between distance on Y: 200~600mm, default 300mm



3. Multiple Copies

The function is used to duplicate images to let you cut quantities of images at a time. The AAS II sensor will automatically scan registration marks for each individual image to ensure the contour cutting precision.

■ **Command:** Esc.D3;(XCopies);(YCopies);(Space):

■ **Layout:**

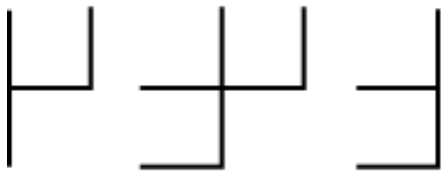
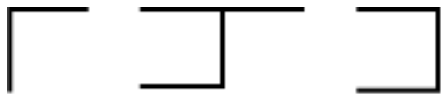

5.3 Printer Test

Before performing AAS contour cutting, it's recommended to print out a test file that you can find in the enclosed Installation DVD to make sure the AAS II cutting accuracy of Puma IV.

There are two testing files for AASII:

1. AAS II_X_Y_Offset_Caberation_A4 .eps (A4 size)
 2. AAS II_X_Y_Offset_Caberation_600_600 .eps (Default setting, it is recommended for testing)
- Print out the testing graphic. (Please use high precision printer)
 - Load the graphic to Puma IV LX models and sent the file to test the cutting job
 - If there are any adjustments to be made, you can change the offset value by following the steps:
 - Measure the offset values from the printed line and the actual cutting line.
 - Enter the AAS Offset under MISC function for the values you just measured, then press Enter
 - Test the cutting again
 - AAS II offset X and Y value is defined as following:
Horizontal line is defined as X and vertical is defined as Y (when facing the cutting plotter)
 - When the actual cutting line and the printed line need to be changed towards the direction of origin mark, then simply add the negative value of the offset. If the direction is from the opposite of the origin mark, then enter positive values for the offset (see the following figures). This method applies to both X and Y axes.

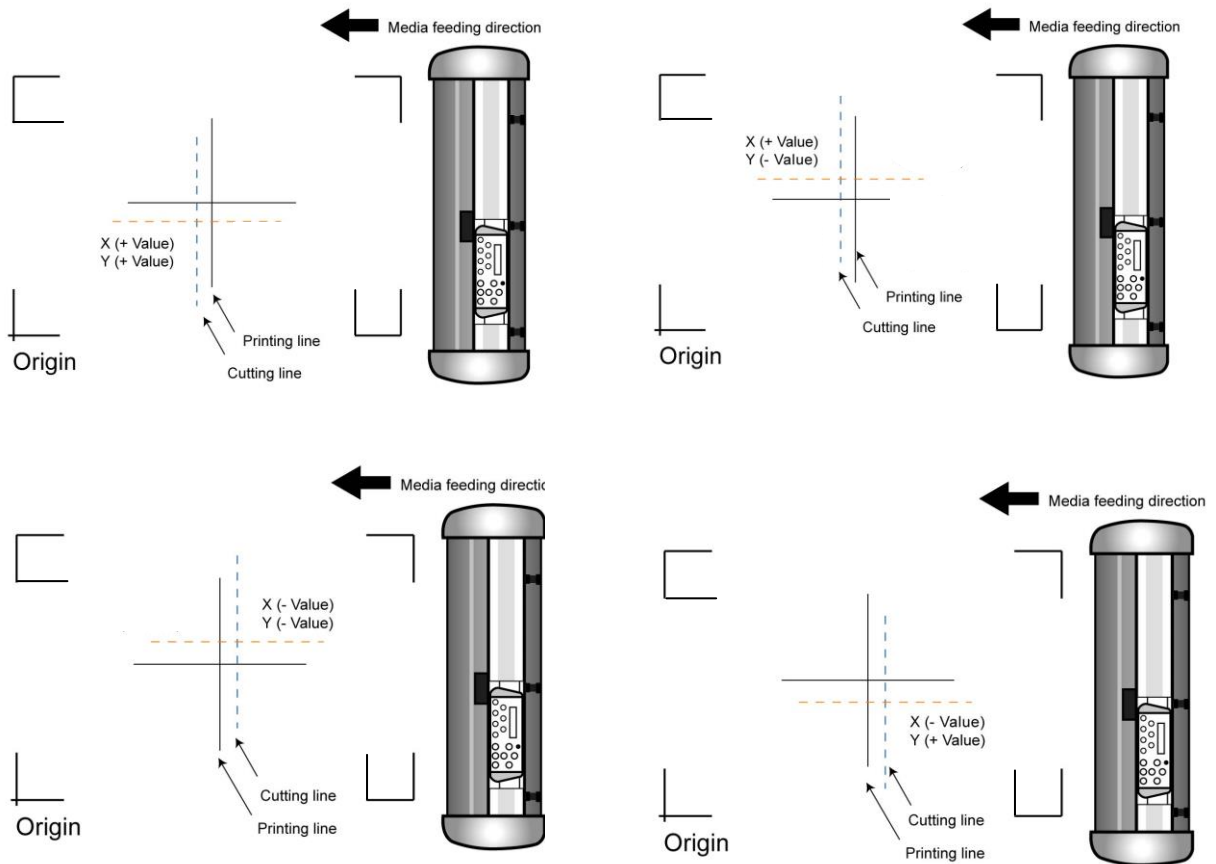
**Note:**

- Before adjusting the AAS II settings, please proceed scaling for width and length.
- The blade offset value isn't set for this test graphic, please set it according to the blade you use.
- If you have any question, please contact us or your local distributor for assistance.

5.4 Registration Mark Offset Range

Please correctly load your media (refer to the alignment ruler on the platen) to make sure the registration marks are successfully detected. Deviation exceeds the range below will lead to detection failure.

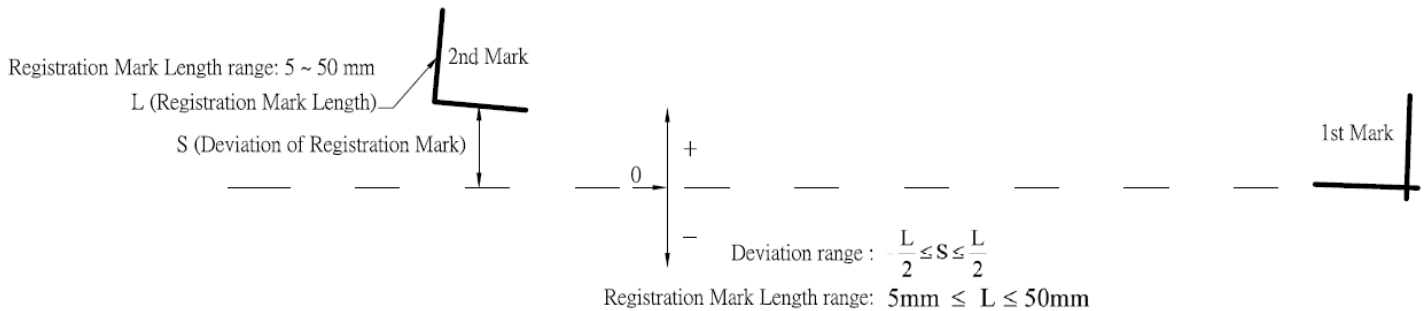

5.5 Contour Cutting

For accurate contour cutting with AAS function, please proceed the following steps:

Step 1 Creating Graphics

- Create the graphic that you want to print and cut in your software.



- Create a contour for cutting around the graphic.



TIPS1: Leave some space between the graphic and contour line.

TIPS2: Create the contour in a separate layer and assign a different color for it.

- Add registration marks around the graphic.

Note:

The Multiple Copies function is also available. It automatically copy the graphic and registration marks.

Step 2 Placing the Registration Marks

- The AAS Layout Instruction:

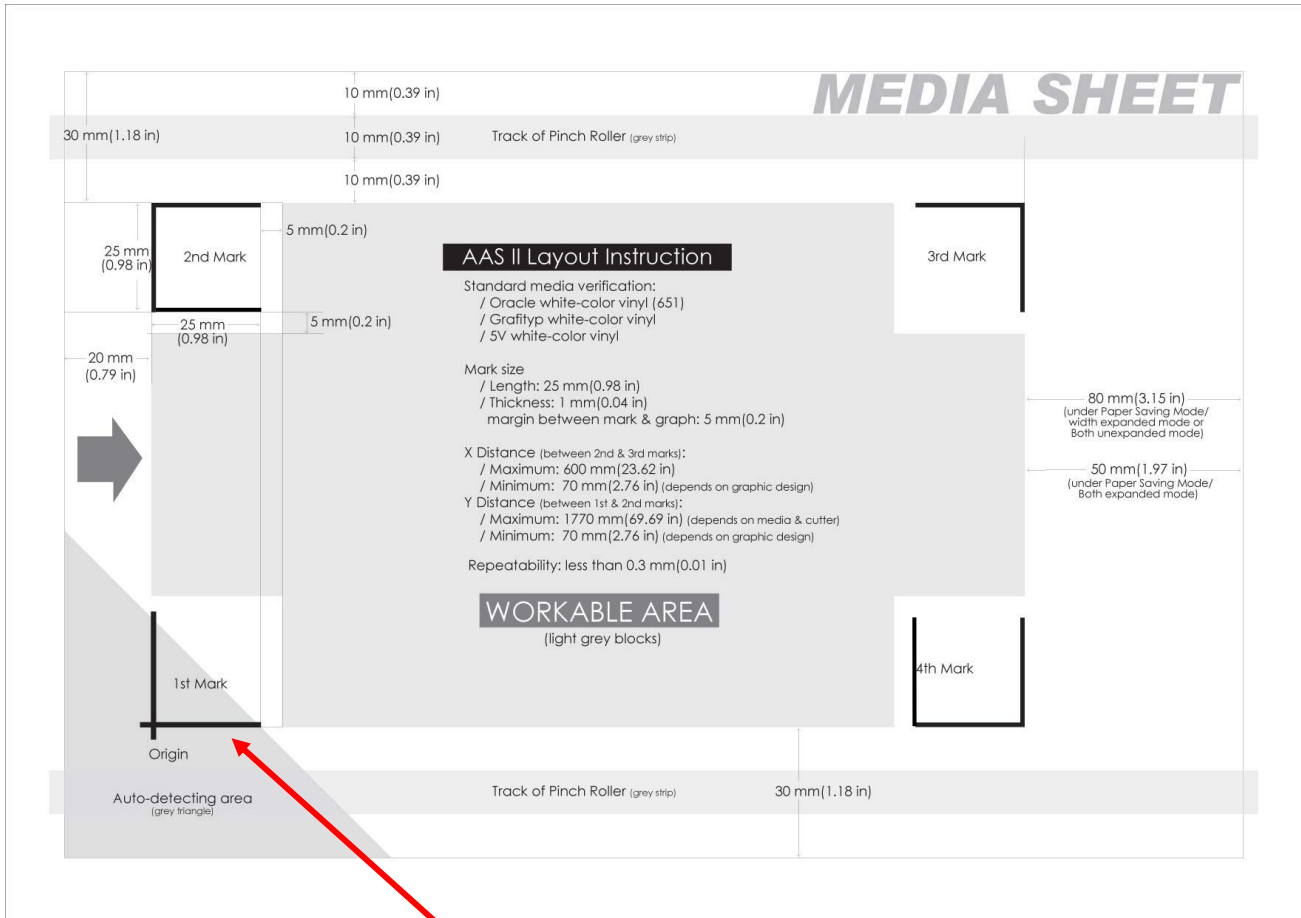

* Auto-detection function on the 1st mark covers the grey area

- Suggested 30mm margin on both left and right sides of media sheet.
- Suggested 20~30mm margin on top of media sheet, and at least 50mm margin on the bottom edge to prevent sheets dropping or any error occurred while media sizing.

Step 3 Print the Graphics

- Print the graphic and the marks with your printer

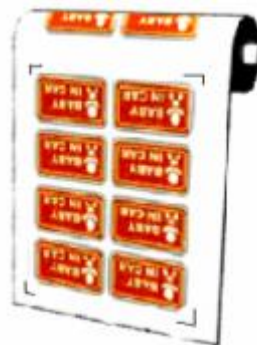

(Scaling = 100%).

- When printing on a roll media, make sure the orientation as following:

Step 4 Load the printout onto cutter

- The Origin Mark is different from the rest registration marks. Please make sure the media is fed with correct direction.

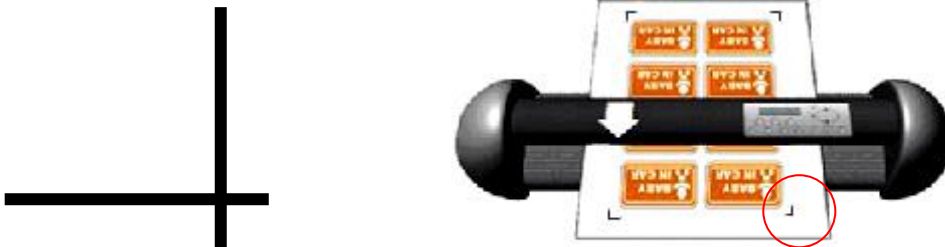
**Step 5 Cut the Contour**

- Send out the command from software to perform the contour cutting job.

5.6 Tips for AAS

For getting better results of contour cutting, there are some tips below for your reference.

- Keep light sources simple and avoid illuminating from the sides of cutter.
- Before operating AAS, change the maximum paper size in Puma IV driver property.

Step 1 Find the **Puma IV LX model** in the “Printer & Fax” folder of your PC.

Step 2 Open the Properties window and select the “Paper” tab.

Step 3 Change the maximum Paper Size of X to **1200mm**.

- Adjust the cutting speed to between 300~600mm/sec.
- Avoid the registration marks locating on the tracks of pinch rollers.
- Make sure the edge of the media is not bent up when detecting registration marks.

Chapter 6 Basic Maintenance

This chapter explains the basic maintenance (i.e. cleaning the cutting plotter) required for the cutting plotter. Except for the below mentioned, all other maintenance must be performed by a qualified service technician.

6.1 Cleaning the Cutting Plotter

In order to keep the cutting plotter under good condition and best performance, you need to clean the machine properly and regularly.

Precaution in Cleaning



- ✧ Unplug the cutting plotter before cleaning
- ✧ Never use **solvents, abrasive cleaners or strong detergents** for cleaning. They may damage the surface of the cutting plotter and the moving parts.

Recommended Methods

- ❖ Gently wipe the cutting plotter surface with a lint-free cloth. If necessary, clean with a damp cloth or an alcohol-immersed cloth. Wipe with water to rinse off any residue and dry with a soft, lint-free cloth.
- ❖ Wipe all dust and dirt from the tool carriage rails.
- ❖ Use a vacuum cleaner to empty any accumulated dirt and media residue beneath the pinch roller housing.
- ❖ Clean the platen, paper sensors and pinch rollers with a damp cloth or an alcohol-immersed cloth, and dry with a soft, lint-free cloth.
- ❖ Wipe dust and dirt from the stand.

6.2 Cleaning the Grid Drum

- ❖ Turn off the cutting plotter, and move the tool carriage away from the area needed to be cleaned.
- ❖ Raise the pinch rollers and move them away from the grid drum for cleaning.
- ❖ Use a bristle brush (a toothbrush is acceptable) to remove dust from the drum surface. Rotate the drum manually while cleaning. Refer to Figure 6-1

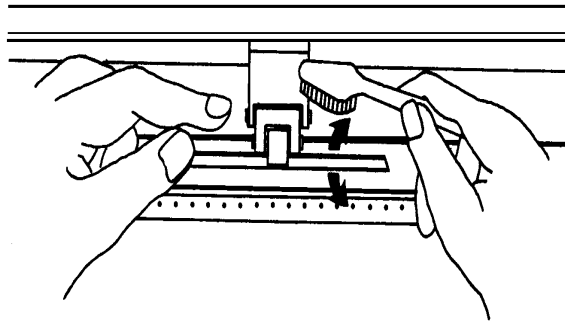

Figure 6-1

6.3 Cleaning the Pinch Rollers

If the pinch rollers need a thorough cleaning, use a lint-free cloth or cotton swab to wipe away the accumulated dust from the rubber portion of the pinch rollers. To prevent the pinch rollers from rotating while cleaning, use finger to hold the pinch rollers not to rotate.

If needed to remove the embedded or persistent dust, use the lint-free cloth or cotton swab moistened with rubbing alcohol.

Note: The daily maintenance of your cutting plotter is very important. Be sure to clean up the grid drum and pinch rollers regularly for better cutting accuracy and output quality.

Chapter 7 Trouble Shooting

This chapter is to help you correct some common problems you may come across. Prior to getting into the details of this chapter, please be sure that your application environment is compatible with the cutting plotter.

Note:

Before having your cutting plotter serviced, please make sure that the malfunction is in your cutting plotter, not the result of an interface problem or a malfunction in your computer or a software problem.



Why doesn't the cutting plotter operate?

Possible Causes:

7.1 Non-Operational Problems

Check the following first:

- Does the AC power cord plug in properly?
- Does the AC power cord connected to the power connector properly?
- Does the power LED still illuminate?

Solutions:

If the LCM is able to display the message, the cutting plotter should be in a normal condition. Switch off the cutting plotter and turn it on again to see if the problem still existing.

If the LCM is not able to display any message, contact the technician from your dealer.

7.2 Operational Problems

Some mechanical problems or failure during operation will cause some problems. The error messages shown on the LCM present the problem first, and followed by recommended actions. If the problem still exists after the recommended actions have been done, have your cutting plotter serviced.

**Error, Check Media
Or Drum or X Motor**

This message indicates that there might be a problem on the **X axis**. Check if the drum is working well and if the media is well loaded. Correct the problem and re-power on to reboot system.

**Error, Check Media
Or Y Motor**

This message indicates that there might be an obstruction to carriage relating to a problem on the **Y axis**. Correct the problem and re-power on to reboot system.

**Error, Check Carriage
Sensor or VC Motor**

This message indicates that the blade up/down sensor malfunction. Re-power on to re-boot system. If the problem still exists, find a serviceman.

**Graph Was Clipped.
Data In Buffer**

This message indicates that the cutting exceeds the cutting limit. Reload larger media or re-scale the plot to a smaller size; then press the key followed by the display of LCM to continue.

7.3 Cutting Plotter/Computer Communication Problems

The messages showed below present problems in relation to cutting plotter/computer communication.

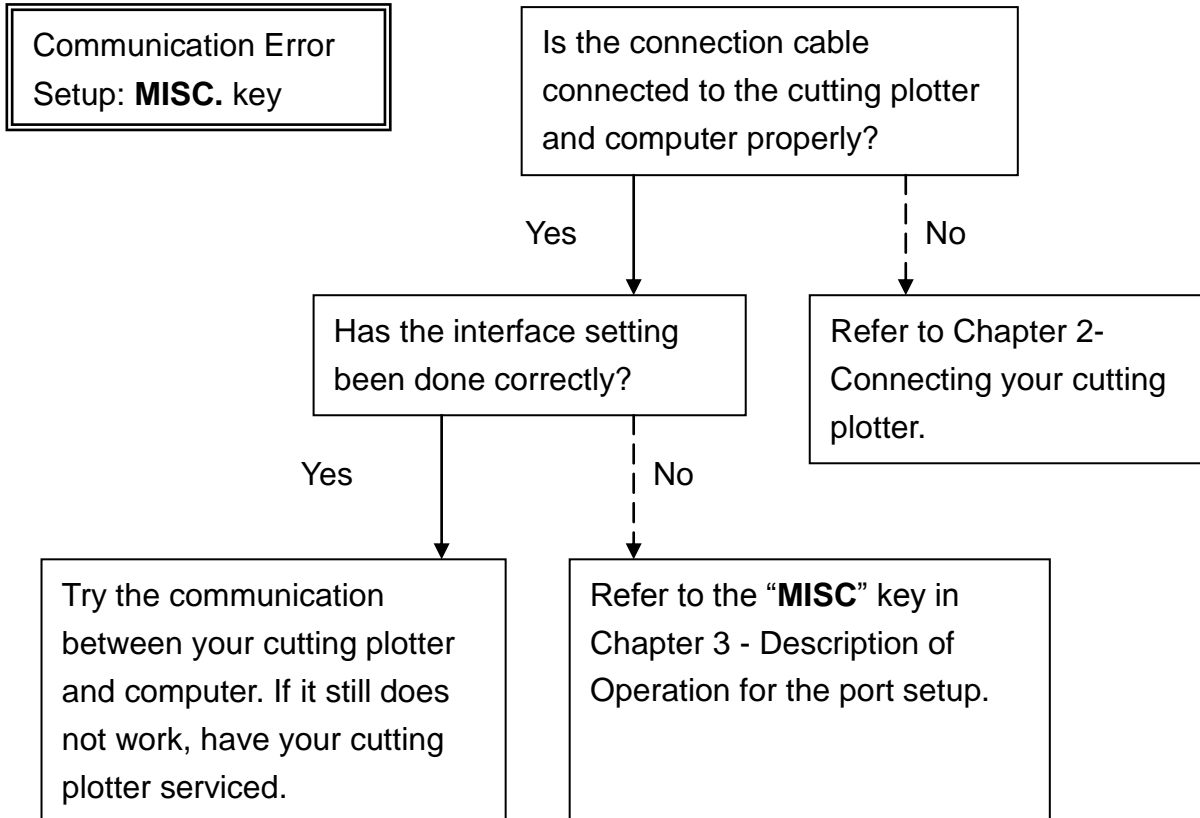

Note:
The computer also needs to set up compatible communication parameters to the cutting plotter set up.

HP-GL/2 Cmd. Error

If your cutting plotter can not recognize the HP-GL/2 or HP-GL commands, please check the HP-GL/2 or HP-GL commands applied to your cutting plotter are used properly.

7.5 Cutting Quality Problems

Note: The daily maintenance of your cutting plotter is very important. Be sure to clean up the grid drum and pinch rollers regularly for better cutting accuracy and output quality.

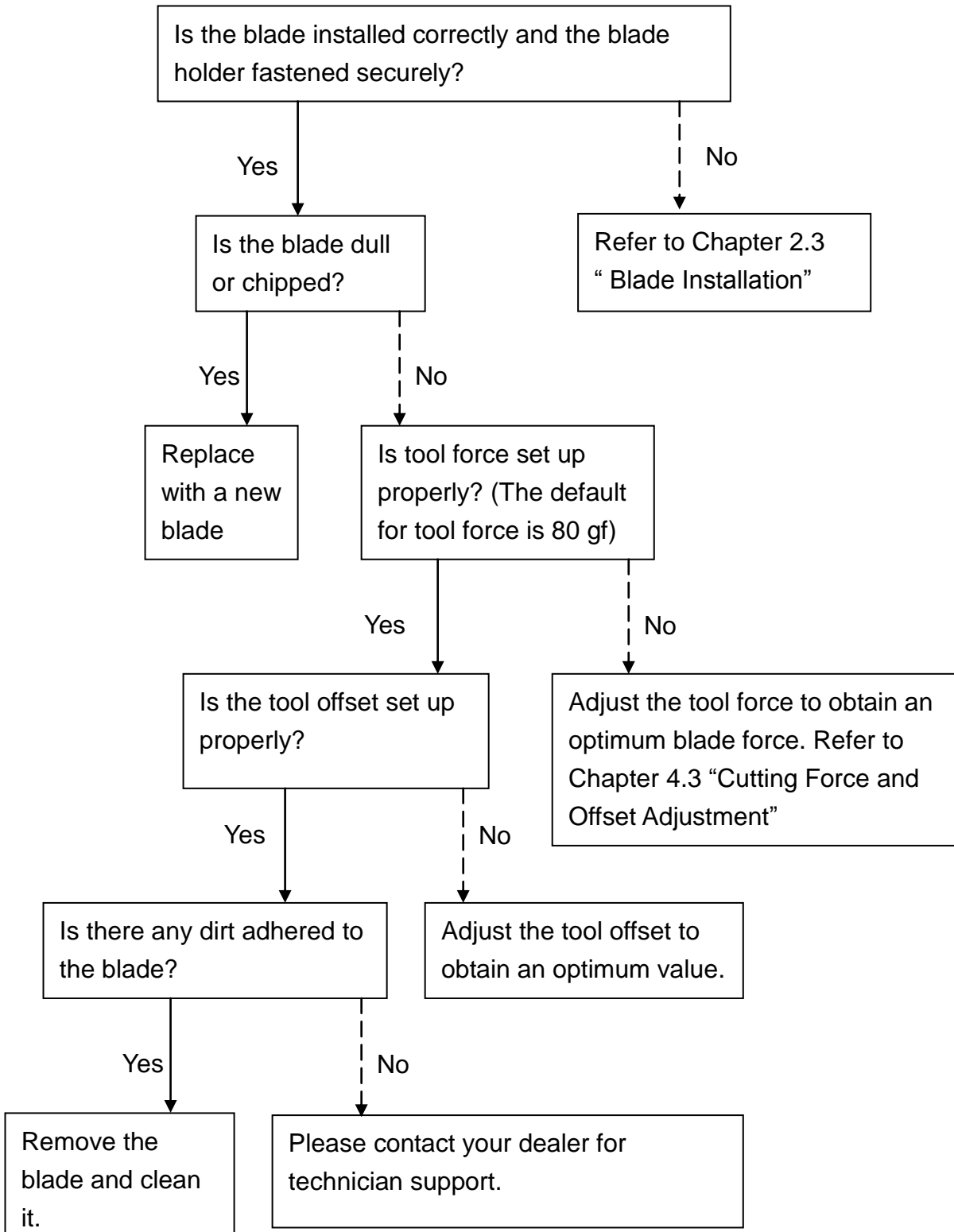





Puma IV Specification

Model Name/No.	P4-60(LX)	P4-132(LX)
Operational Method	Roller-Type	
Max. Cutting Width	600 mm (23.6 in)	1300 mm (51.18 in)
Max. Cutting Length	50 m(164 ft)	
Max. Media Loading Width	719 mm (28.3 in)	1470 mm (57.87 in)
Min. Media Loading Width	50 mm (1.97 in)	
Acceptable Material Thickness	0.8 mm (0.03 in)	
Number of Pinch Rollers	2	4
Motor Drive	DC Servo Control	
Cutting Force	5~500 g	
Max. Cutting Speed	1020 mm /sec (40.16 ips) (at 45° direction)	
Offset	0~1.0 mm (with an increase of 0.025 mm)	
Mechanical Resolution	0.009 mm (0.00035")	
Software Resolution	0.025 mm (0.00098")	
Distance Accuracy	±0.254 mm or ±0.1% of move, whichever is greater	
Repeatability	±0.1mm within 3 meters (* certified media)	
Automatic-Aligning System	Available on Puma IV LX models, including Segmental Positioning and Auto Rotation functions	
Memory Buffer	32 MB / 16 MB (when using AAS)	
Interfaces	USB 2.0 (Full Speed), Serial (RS-232C) and Ethernet	
Type of Command	HP-GL, HP-GL/2	
Control Panel	LCD (20 digits x 2 lines), 14 Keys, 1 Power LED	
Diameter of Blade	2.5 mm	
Dimension (HxWxD) mm	220x 879x258 8.67 x34.61x10.16 in	1065 x 1632 x 620 (including stand) 41.93 x62.25x24.41 in
Net Weight	13kg / 28.6lb	53 kg / 116.4 lb
Stand	Optional	Standard
Power Supply	AC 100-240V, 50~60 Hz (auto switching)	
Power Consumption	Max.110 watts	
Environment Temperature	15°C ~35°C / 60°F ~86°F (operating)	
Environment Humidity	25%~ 75% relative humidity (operating)	

- Compatible with Windows 7 and above and MAC OS X 10.6 and above.
- The specification and data sheet may vary with different materials used. In order to obtain the best output quality, please maintain the machine regularly and properly.
- GCC reserves the right to change the specifications at any time without notice.
- GCC certified material in tracking is Avery MPI 3000.
- The above listed specification values are effective only when operated with media certified by GCC.

Blade Specification

202003480G	For cutting thick fluorescent and reflective vinyl. Also for cutting detailed work in standard vinyl.
	The blade is 45° with Red Cap (5-unit package), 0.25 mm offset, and 2.5 mm blade diameter.
	
290088080G	For cutting reflective vinyl, cardboard, sandblast, flock, and stencil sharp edge.
	The blade is 60° with Green Cap (2-unit package), 0.50 mm blade offset, and 2.5 mm blade diameter.
	
265017550G	For cutting thin sandblast mask and stencil. The blade with sharp angle and special design, allowing it to maneuver around sharp corners.
	The blade is 60° with Blue Cap , 0.25 mm blade offset, and 2.5 mm blade diameter.
	
265017560G	For Cutting small text and fine detail. Sharp blade with smallest offset.
	The blade is 50° with Black Cap , 0.175 mm blade offset, and 2.5 mm blade diameter.
	
265017530G	For thin and delicate media such as window tint.
	The blade is 25° with Yellow Cap , 0.25 mm blade offset, and 2.5 mm blade diameter.
	

About the Tool

A generic term referring to the blade that cuts the sheet, the pen that does plotting, and the LED bombsight (option) used for pointing to the reference point.

OFFSET is the distance that the blade tip is displaced from the centerline of the blade.

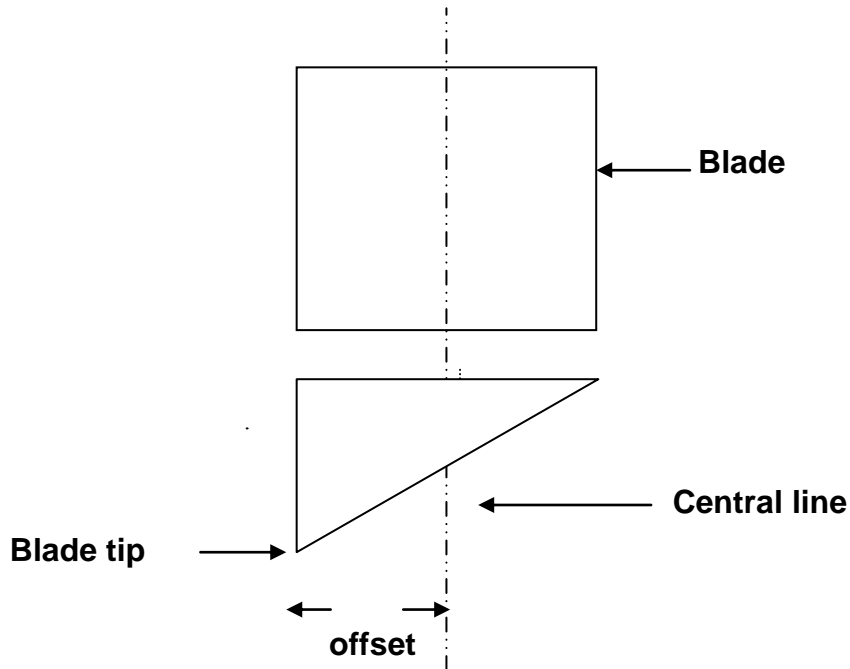

Protrusion Length of the Blade

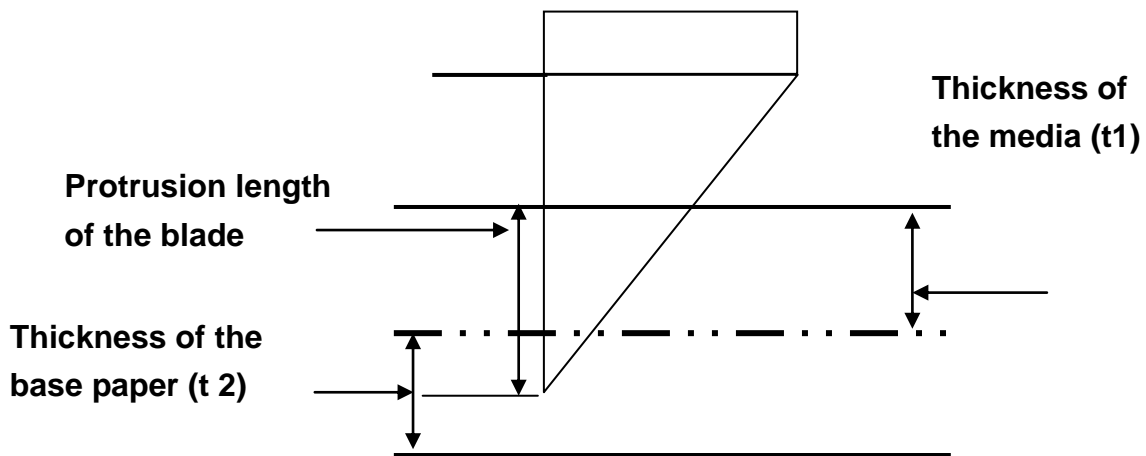

Length of protrusion = $t1 + t2 / 2$, but for your convenience you may just make it about 0.3mm ~ 0.5mm beyond the blade holder tip.

CoreDRAW Output Instruction

The following is an example of how to output the file through CoreDRAW.

User Instructions

1. Open CoreDRAW, finish editing all the files you wish to plot and select all the images at once.
2. Select “Outline Pen” to adjust the outline for cutting.

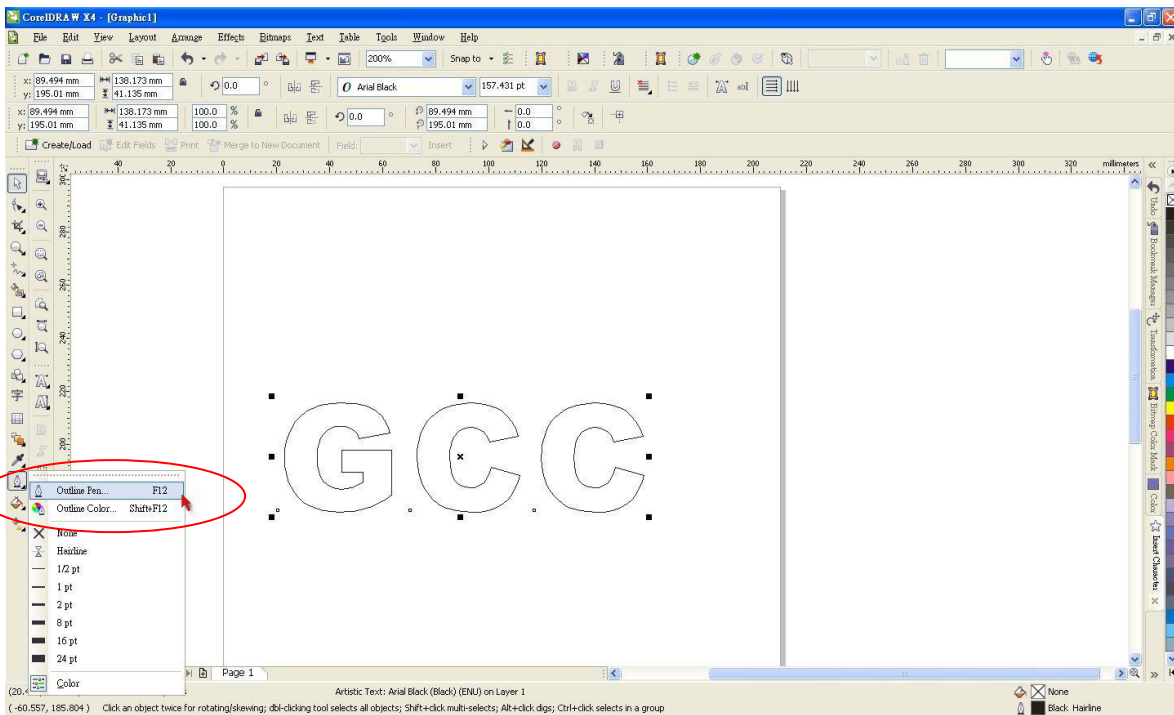

3. Adjust the value of pen width to 0.001 mm and click “OK” to save your input.

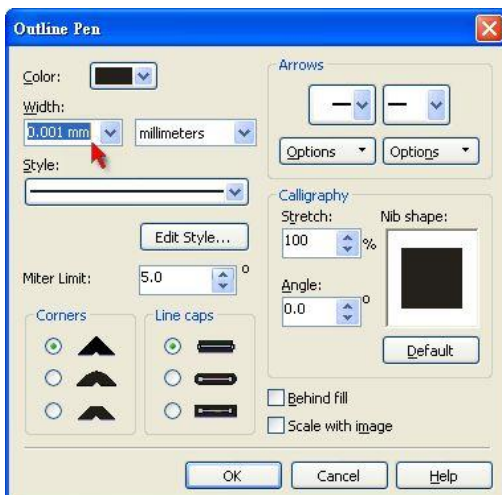

4. Select “File → Print” to output the file to your cutters.

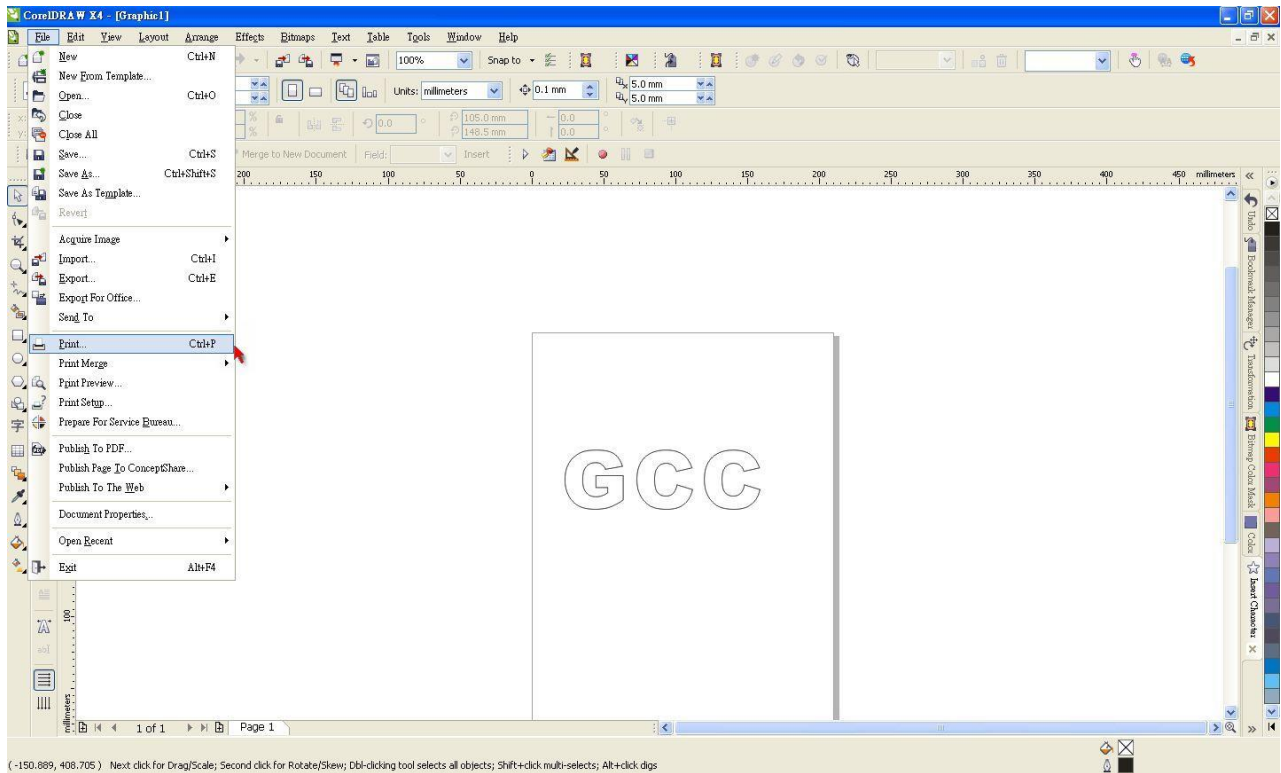

5. Choose the correct model you have installed.

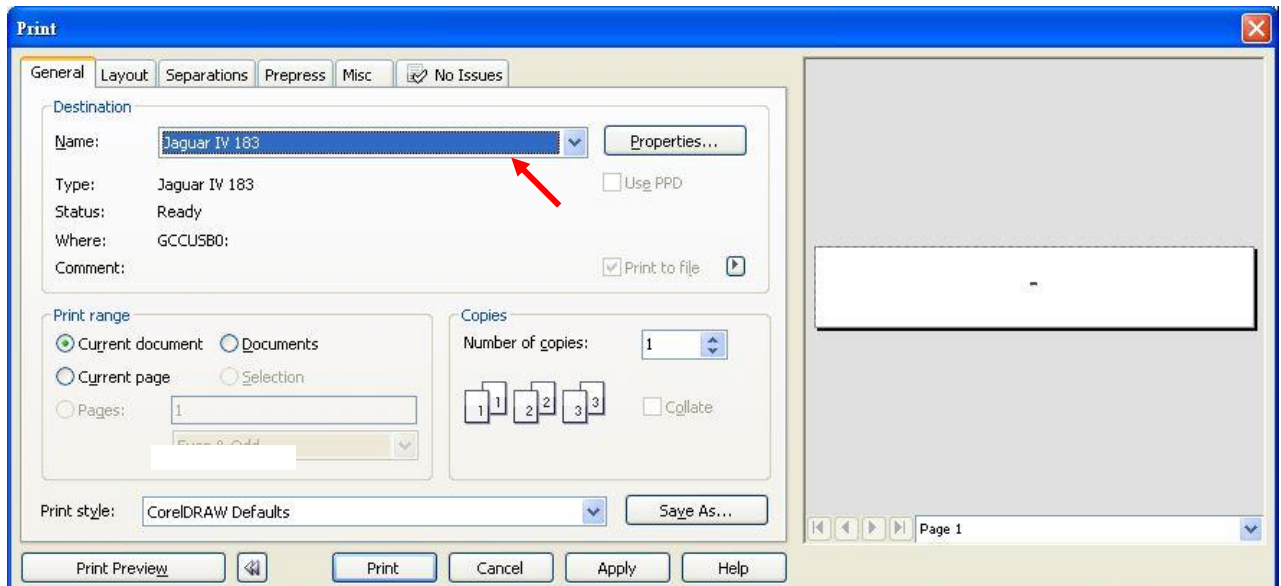

6. Choose the “Layout page” and click the “Reposition images to: → Bottom left corner”.
Please note that you must put your image at the bottom left corner.

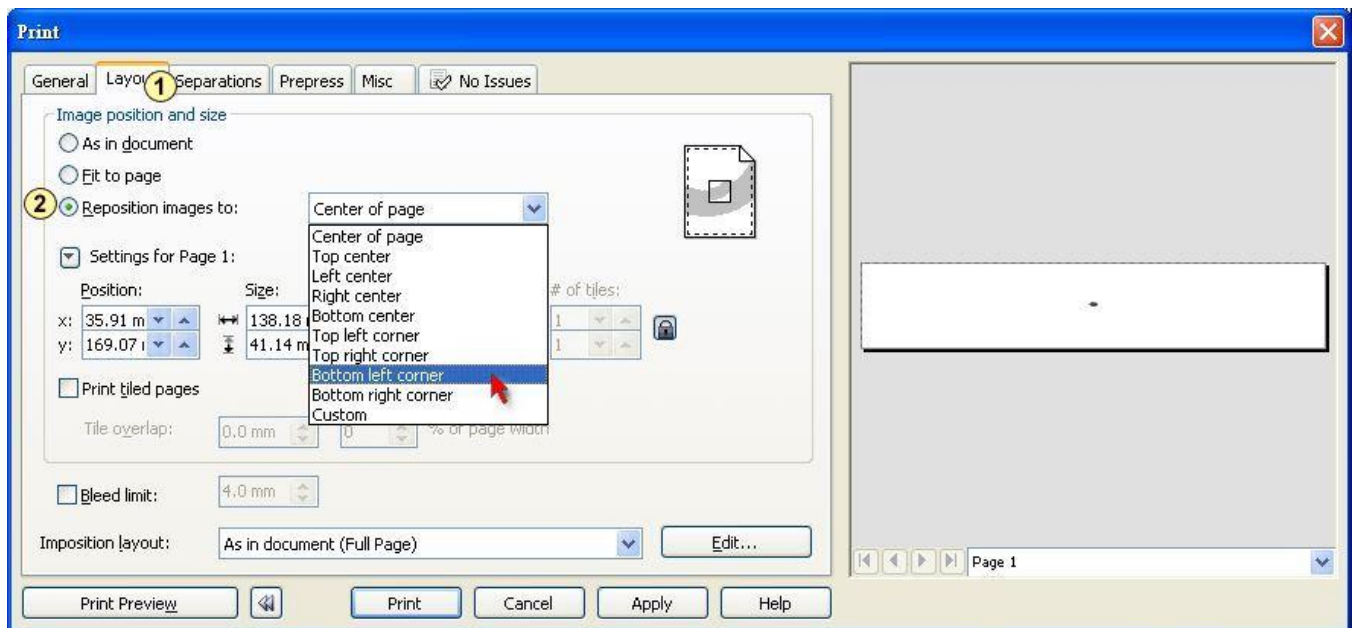

7. Go back to the General page and check that your image is at the bottom left corner. Click “Print” and get a wonderful cutting image.

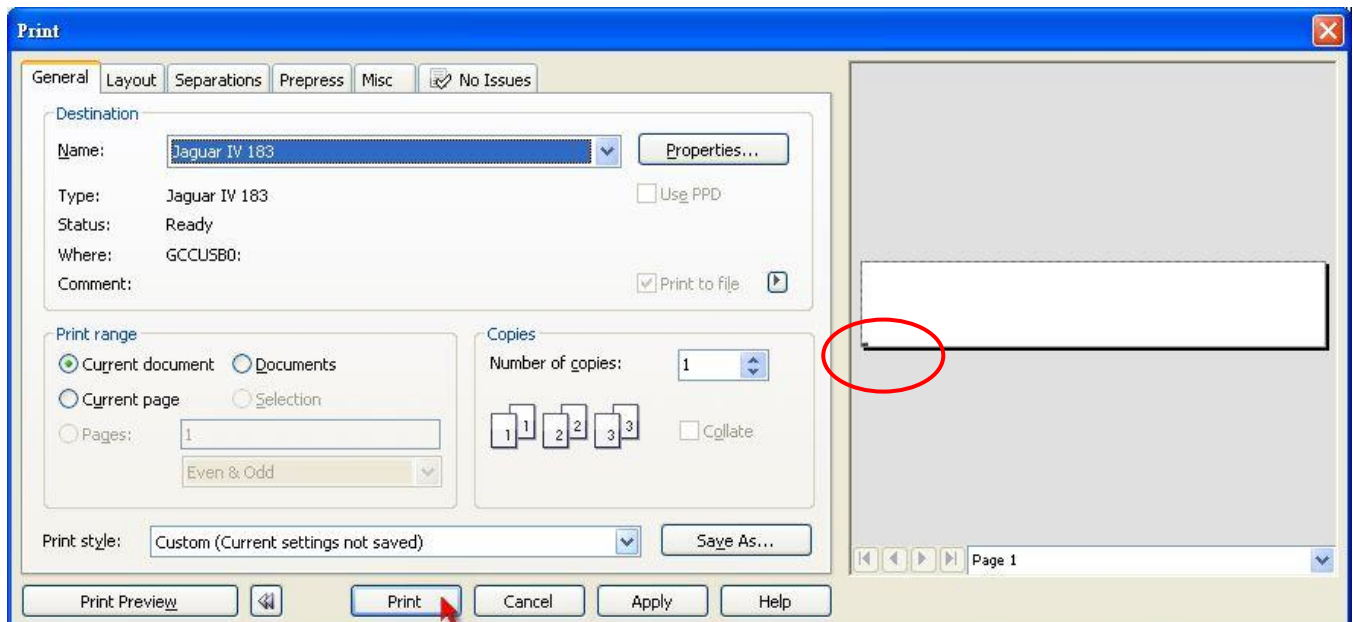

CoreIDRAW Plug-In Instruction

Puma IV LX cutting plotter features AAS function, but **Puma IV** doesn't. If you are **Puma IV** user, please skip this chapter.

[AASII VBA Installer](#) is applicable for CoreIDRAW Version 13, 14, 15, 16, 17, 18

Installation

Please refer to Step 8 in Chapter 2.6.1.2 Driver Installation to install AAS plug-in for CoreIDRAW.

Run CoreIDRAW AAS Plug-in

Step 1 Run CoreIDRAW to edit your graphics and select all images at once when you wish to plot.

Step 2 Select "Tools→Macros→Run Macro." Then select **Global Macros** (**GCCAASII_Draw13.gms**) under the "Macros in" manual, and press "Run".

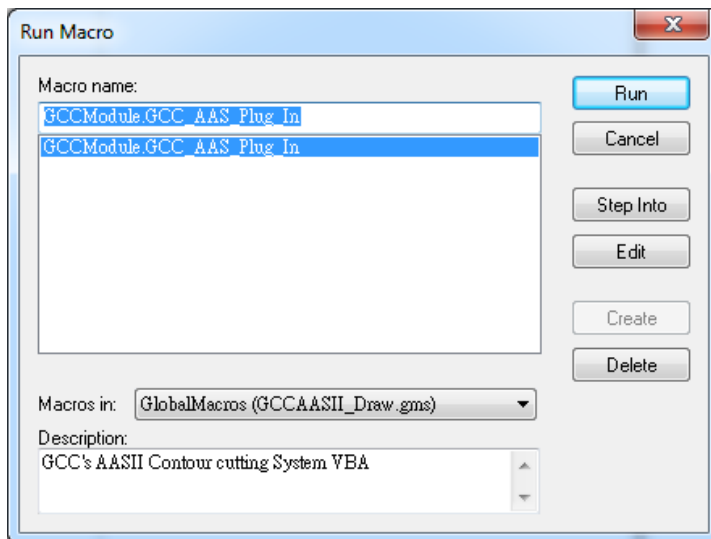

Step 3 Click on “Apply” and select whether you would like to add the registration marks by page size or by object.

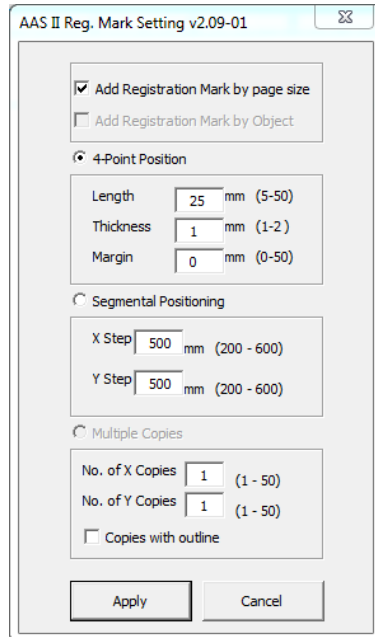

Step 4 Now you can print out the image file with registration marks.

Note: “Add Registration Mark by Object” will be the default selection if you click on the image whereas “Add Registration Mark by page size” will be the default one when the blank area on the page is clicked.

You can also add a Hot Icon for the AAS Plug-in

Select “Tools→ Options→ Workspace→ Customization→ Commands→ Macros→ GCCMadual.GCC_AAS_Plug_In” and Click OK.

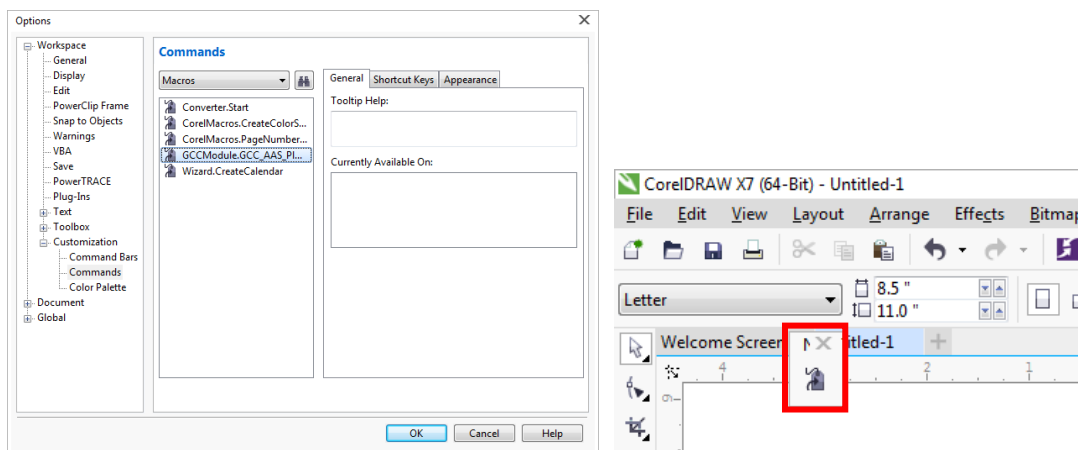

Add Registration Mark by page size

If you tick “Add Registration Mark by page size” as shown in the figure below and click “Apply”, your registration marks will be created automatically (please see Figure A3-1).

Note:

1. The length setting will be in the range of 5-25mm according to your page size.
2. Please **DO NOT** make any changes to the “Origin” section when you choose to add registration marks by page size as indicated below otherwise the position of the marks will be changed (please see Figure A3-2).

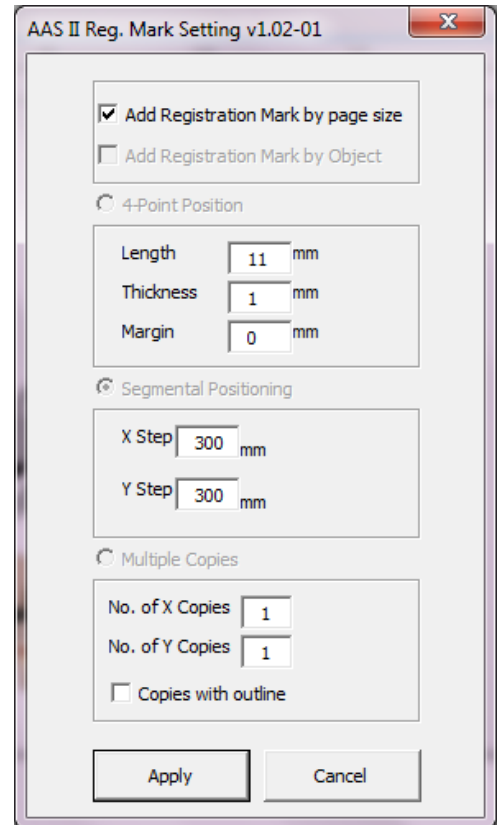

Figure A3-1

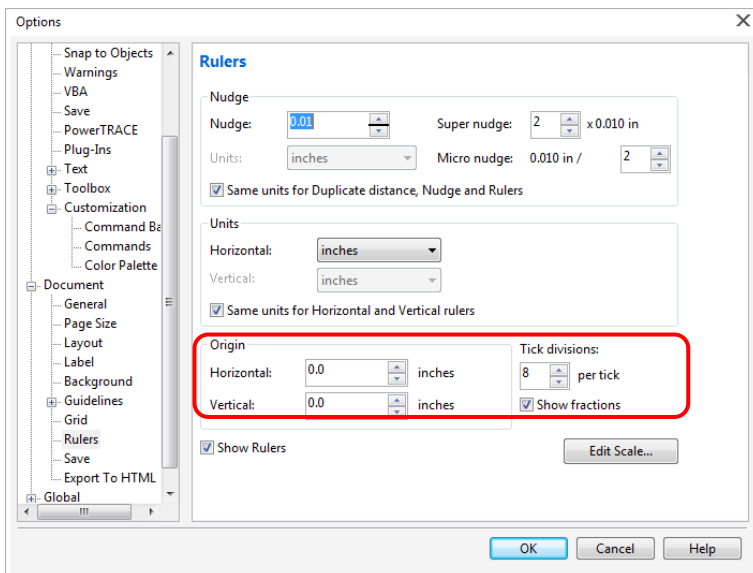

Figure A3-2

The system will create the 4 marks on the 4 corners of the page as shown in the picture below wherever you move your image.

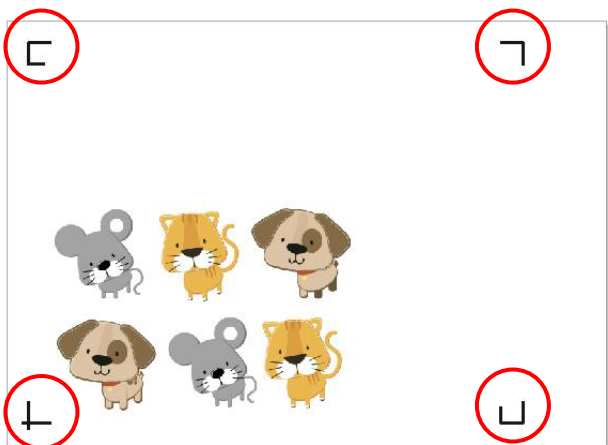

Figure A3-3

Workable area

It allows users to edit and cut graphics in the area outside the registration marks when adding registration marks by page.

For A4 size media sheet, the workable area is 2.5mm extended from the registration mark on left and right sides and 4.5mm extended from the registration mark on top side. On the bottom side, it is suggested to leave at least 25mm margin from the edge of media sheet to prevent sheets dropping or any error occurred while media sizing.

For A3 size media sheet, the workable area is 10mm extended from the registration mark on the left side, 9mm extended from the registration mark on the right side and 11mm extended from the registration mark on top side. On the bottom side, it is suggested to leave at least 25mm margin from the edge of media sheet to prevent sheets dropping or any error occurred while media sizing.

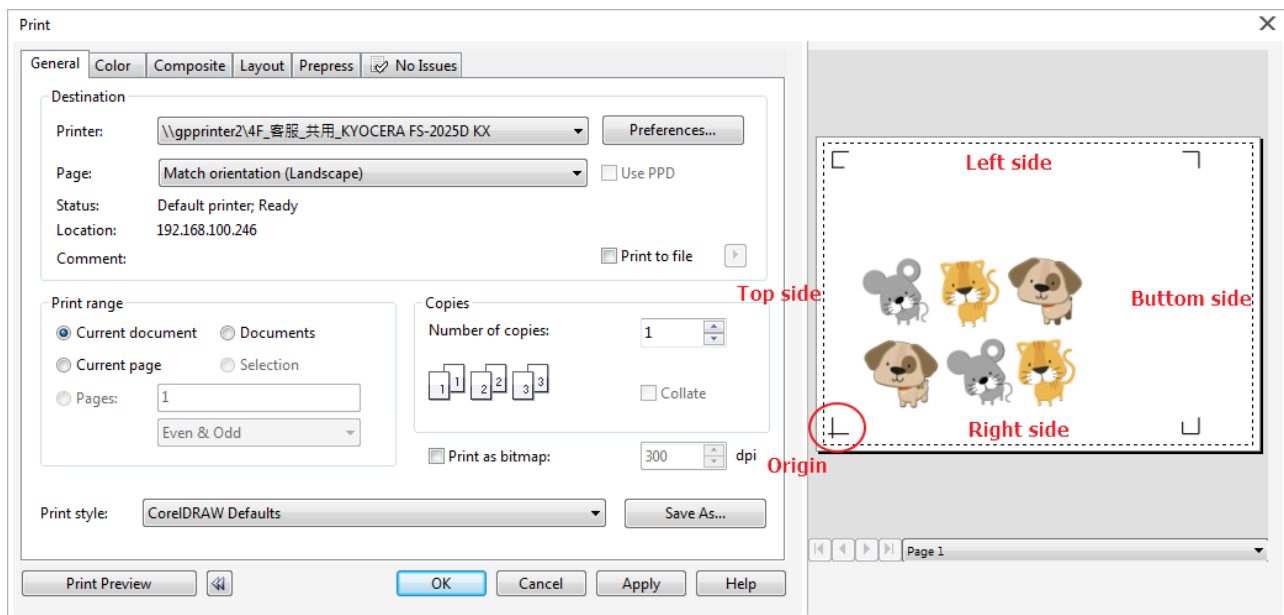

Note: Select “Edge” mode when media sizing to allow the media sheet to be unrolled. If you select “Single” mode, the media sheet will not be able to be moved back and hence fail to be detected by front paper sensor.

Add Registration Mark by Object

If you tick “Add Registration Mark by Object”, you will be offered three options of registration marks as shown below.

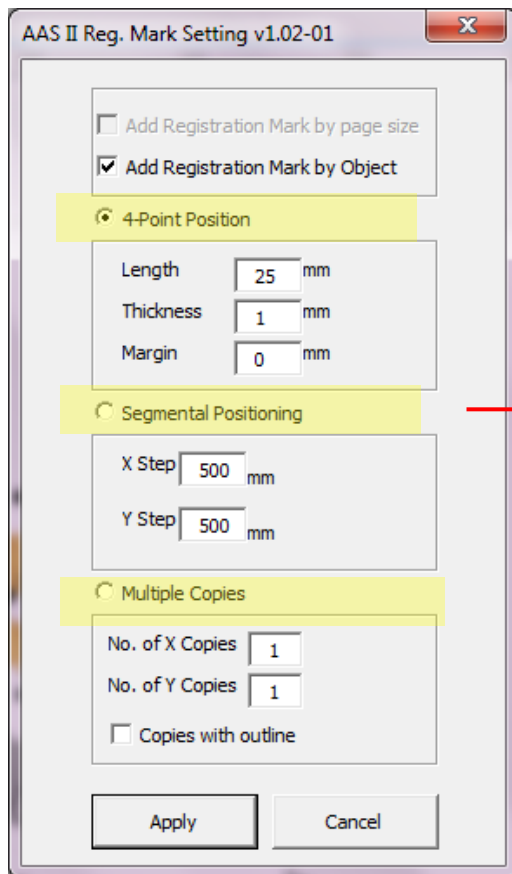

Figure A3-4

4-Point Positioning

- Length: The length of marks
→ Range: 5mm~50mm
→ Optimized Setting: 25mm
- Thickness: The line thickness of marks
→ Range: 1mm~2mm
→ Optimized Setting: 1mm
- Margin: The distance between marks and images
→ Range: 0mm~50mm
→ Optimized Setting: 5mm

Segmental Positioning

- X Step: The distance of intermediate position on the X axis
- Y Step: The distance of intermediate position on the Y axis
→ Range: 200mm~600mm
→ Optimized Setting: Less than 500mm

Multiple Copies

- No. of X Copies: The numbers of copies on X axis
- No. of Y Copies: The numbers of copies on Y axis
→ Range: 1~50. (The more copies you make, the more time is needed for data transmission.)
→ Numbers of X Copies * Numbers of Y Copies = The total amount of image copies
- Copies with outline: To show outlines of image graphics

Note: The values entered in the “4-Point Positioning” section (length, thickness and margin) will still be applied when you tick “Segmental Positioning” or “Multiple Copies”.

4-Point Positioning

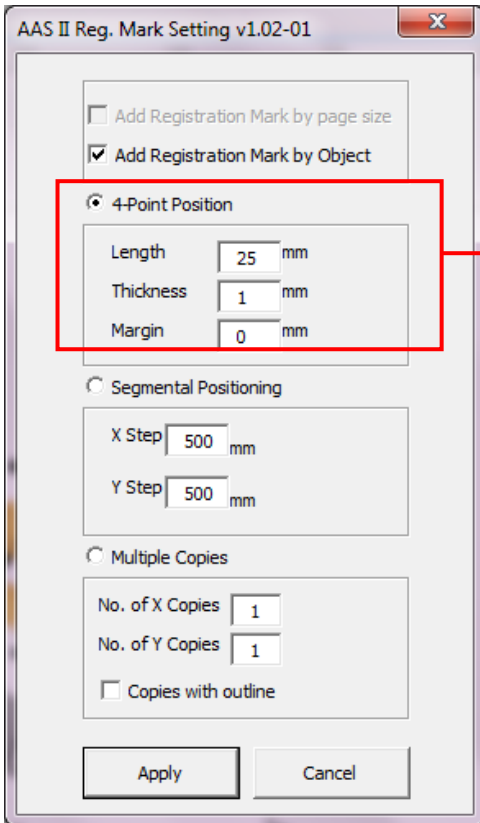

4-Point Positioning

- Length: The length of marks
→ Range: 5mm~50mm
→ Optimized Setting: 25mm
- Thickness: The line thickness of marks
→ Range: 1mm~2mm
→ Optimized Setting: 1mm
- Margin: The distance between marks and images
→ Range: 0mm~50mm
→ Optimized Setting: 5mm

Figure A3-5

The system will create the 4 marks as shown in the picture below.

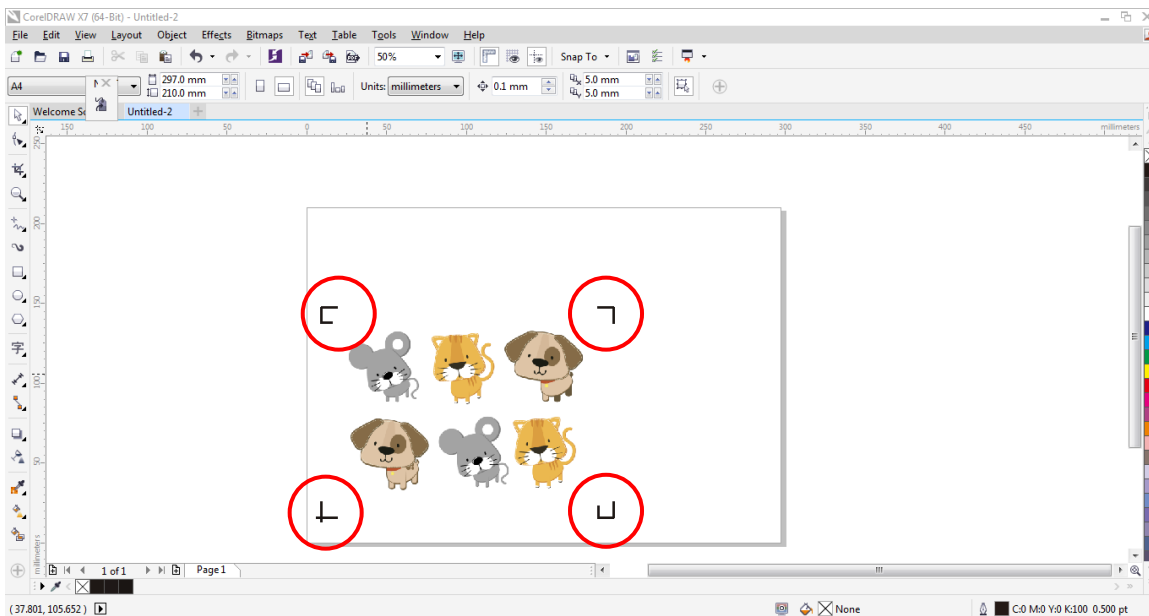
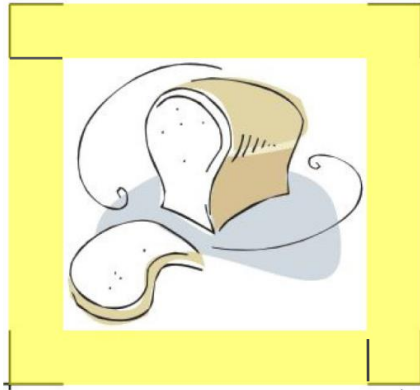

Figure A3-6

Note:

- To save your materials, in addition to amending object margins, you can also adjust the length of the registration marks (5mm minimum) when you apply 4-Point Positioning (see table 1 for suggestions based on different material sizes). The smaller the size is, the smaller the distance between the object and the registration marks is (see the figures below).

**Figure A3-7**

25mm

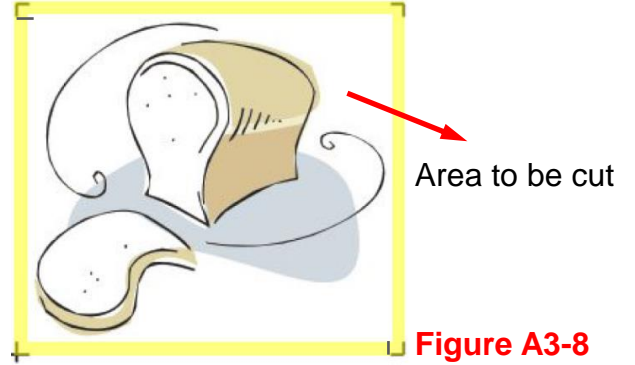
**Figure A3-8**

5mm

Page size (unit: mm)	Suggested mark length (unit: mm)
A6 (105 x 148)	5
A5 (148 x 210)	8
A4 (210 x 297)	11
A3 (297 x 420)	16
A2 (420 x 594)	23
A1 (594 x 841) and above	25*

Table 1

*25mm is the suggested value for the registration mark length

- The size of the registration marks would affect the accuracy of registration mark detection so please make sure the amount you enter is reasonable.
- If you change the paper size, you will have to reset the registration marks otherwise the previous setting will be applied.

Segmental Positioning

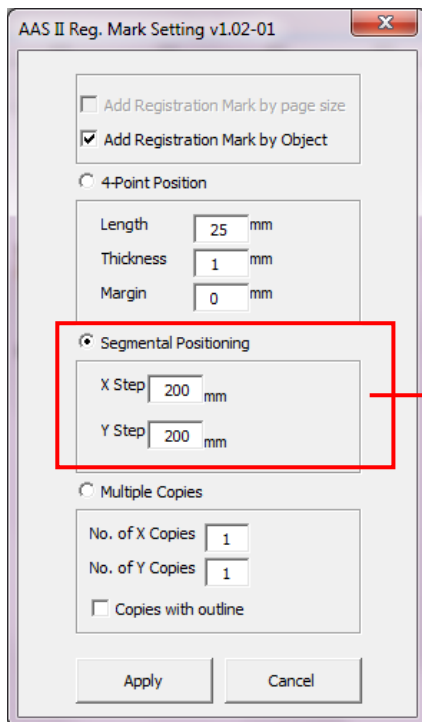

For precise cutting quality, it is suggested to select “Segmental Positioning” when you are working on an extra long or large-sized image to increase cutting accuracy.

Segmental Positioning

- X Step: The distance of intermediate position on the X axis
- Y Step: The distance of intermediate position on the Y axis
 - Range: 200mm~600mm
 - Optimized Setting: Less than 500mm

Figure A3-9

The system will create the as shown in the picture below

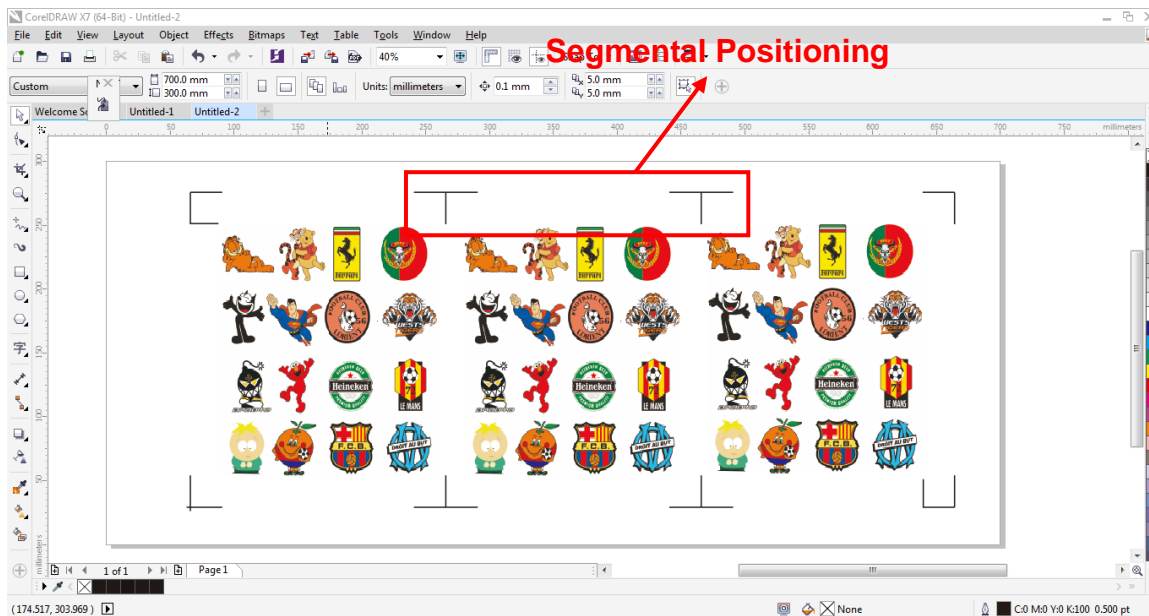
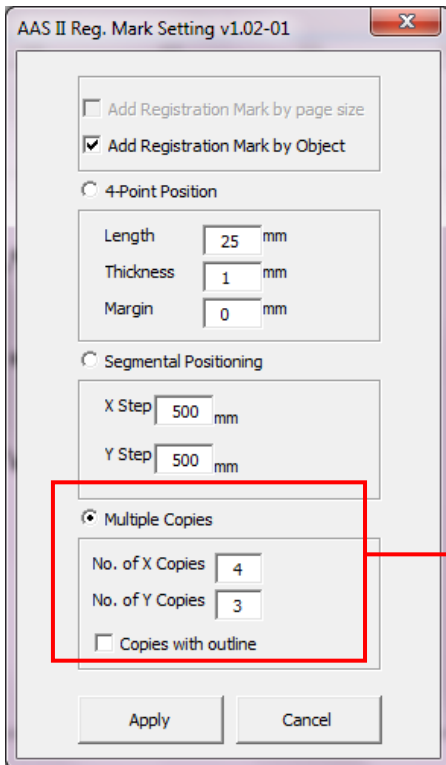

Figure A3-10

Segmental Positioning will be applied to Multiple Copies when the object to be copied is of large size (with the length or width over 200mm) to increase the accuracy of registration mark detection.

Multiple Copies

It is suggested to select “Multiple Copies” when you would like to make several copies of one image on your material to increase cutting accuracy.



Multiple Copies

- No. of X Copies: The numbers of copies on X axis
- No. of Y Copies: The numbers of copies on Y axis
→ Range: 1~50. (The more copies you make, the more time is needed for data transmission.)
→ Numbers of X Copies * Numbers of Y Copies = The total amount of image copies
- Copies with outline : To show outlines of image graphics

Figure A3-11

The system will create the as shown in the picture below.

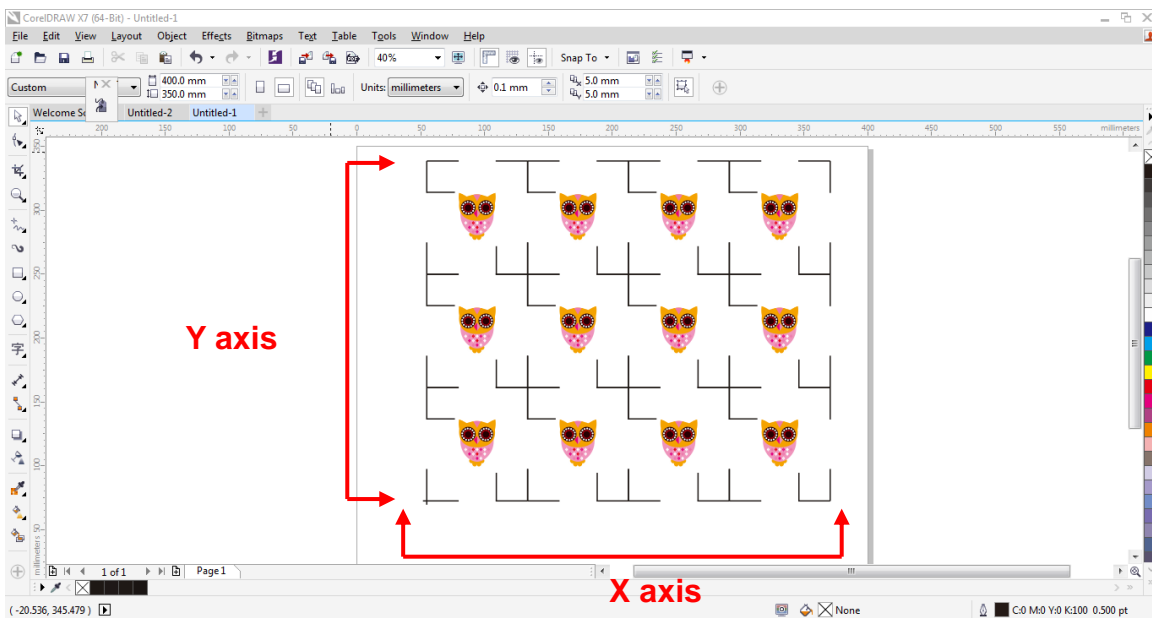

Figure A3-12

Contour cutting through CorelDraw

Step 1 Position the paper with registration marks printed by your printer on the GCC cutter.

Step 2 Select “Files→Print”.

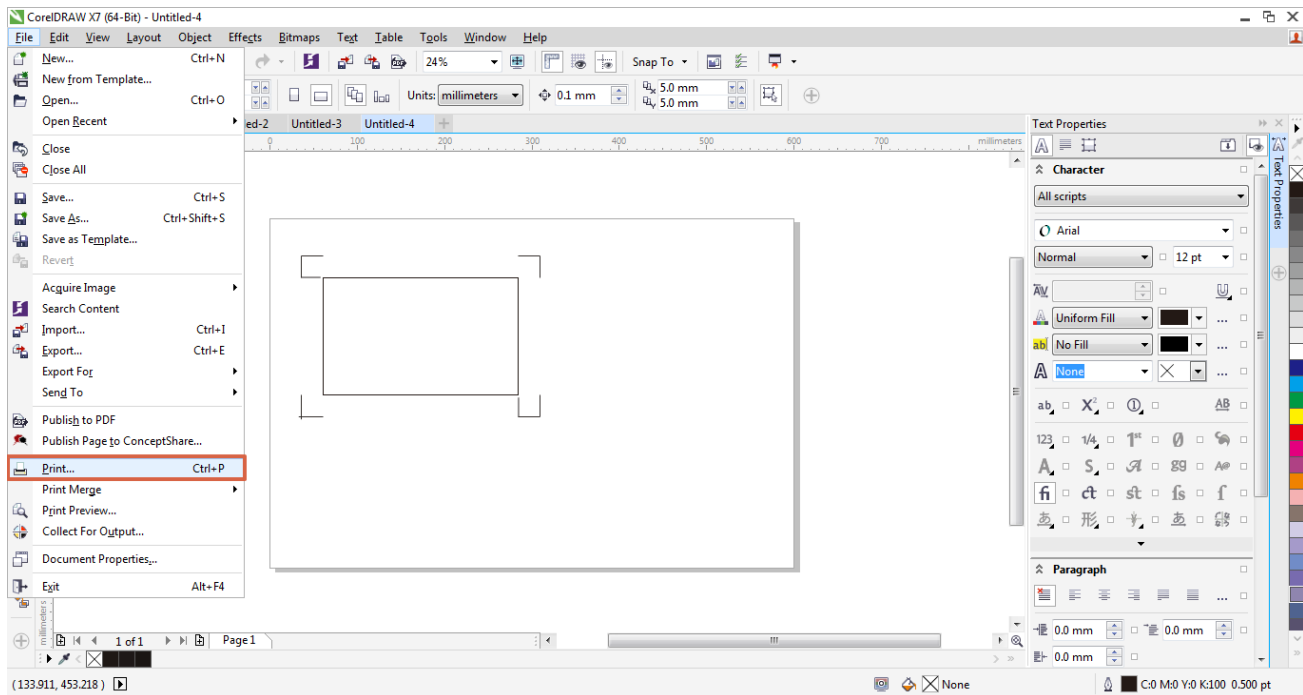

Figure A3-13

Note: if you use CorelDraw X5 and later, you must follow the steps below.

Step 1 Click the “color” page and go to the “Color conversions performed by:” and then select the model name of you cutter (please refer to Figure A3-14).

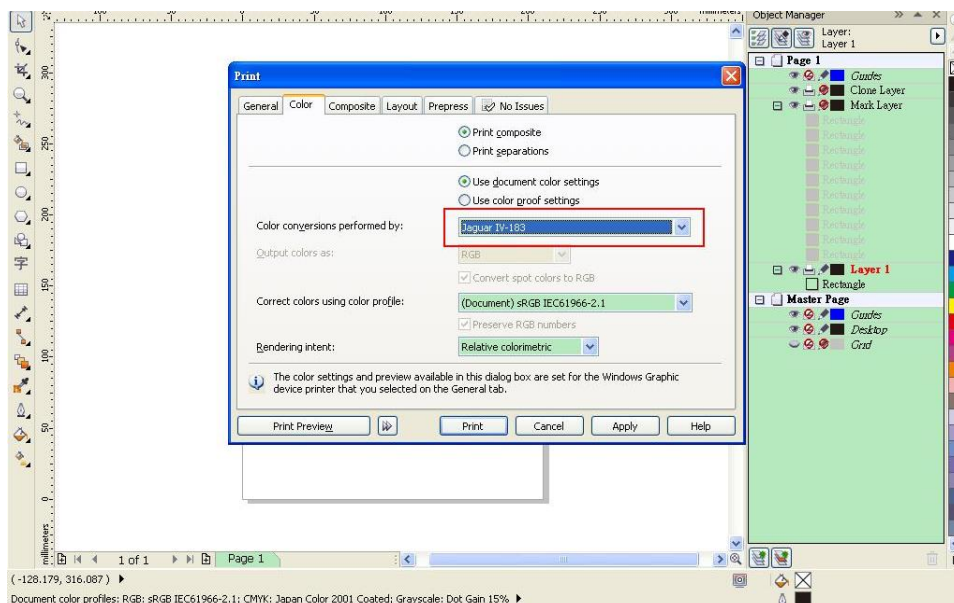

Figure A3-14

Step 2 Go to the “Layout” page and select Bottom left corner at “Reposition images to”.

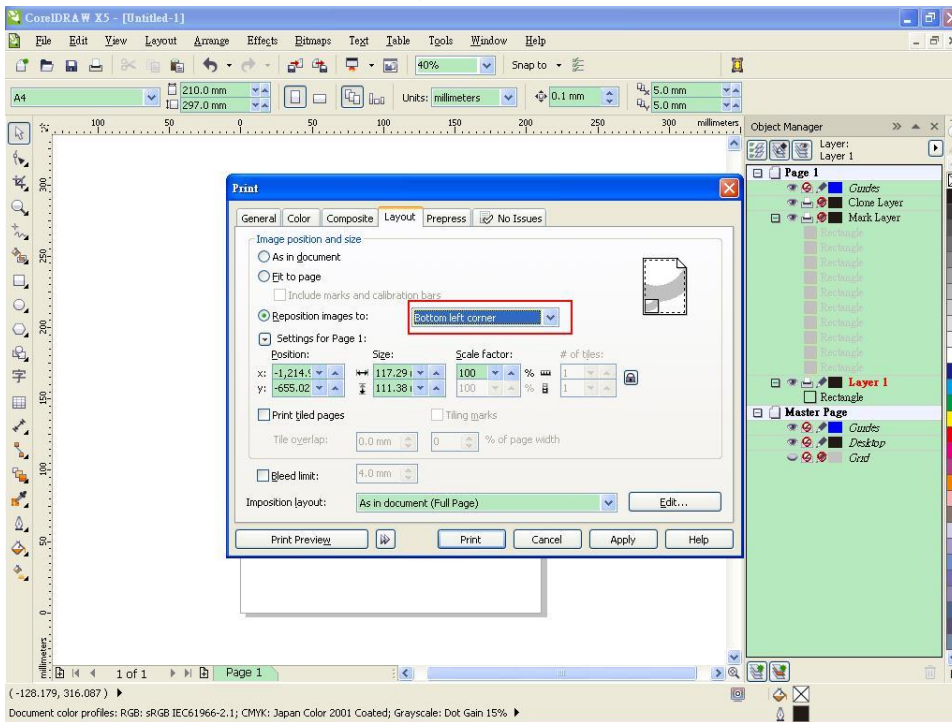

Figure A3-15

Step 3 Click “Print”.

Illustrator Plug-In Instruction

Puma IV LX cutting plotter features AAS function, but **Puma IV** doesn't. If you are **Puma IV** user, please skip this chapter.

[AASII VBA Installer](#) is applicable for Adobe Illustrator Version CS4, CS5, CS6, CC.

Installation

Please refer to Step 8 in Chapter 2.6.1.2 Driver Installation to install AAS plug-in for Adobe Illustrator.

Printer Setting

Step 1 Go to Control Panel, right click on the printer and select Printer Properties to open the Printer Properties page

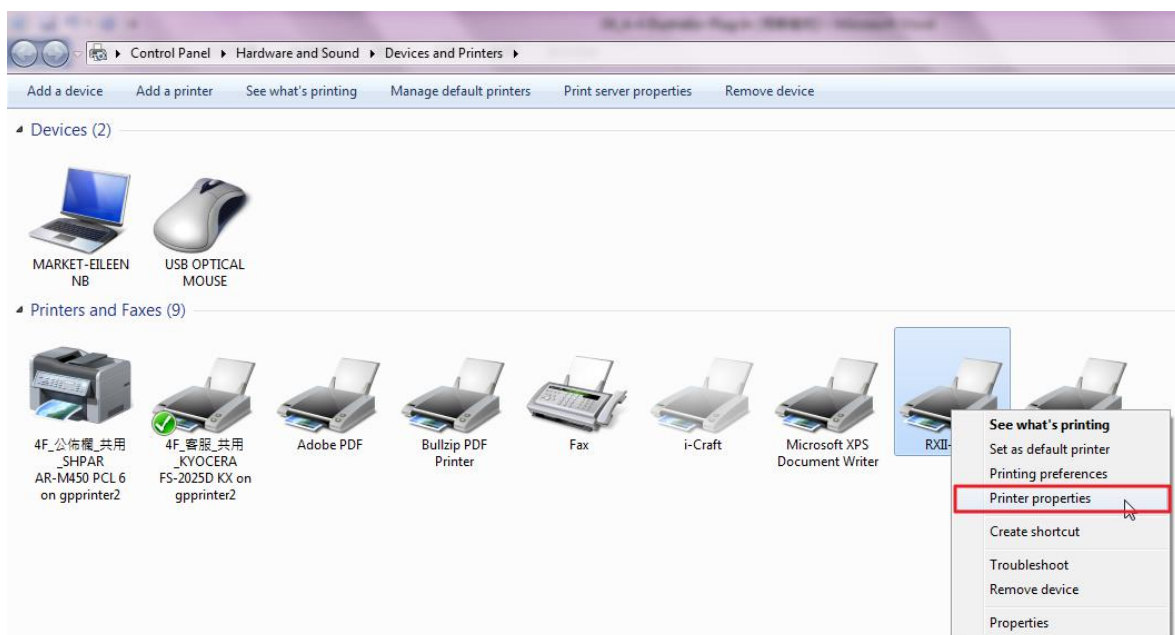

Step 2 Go to the Advanced page and make sure the “Enable advanced printing features” box is unchecked.

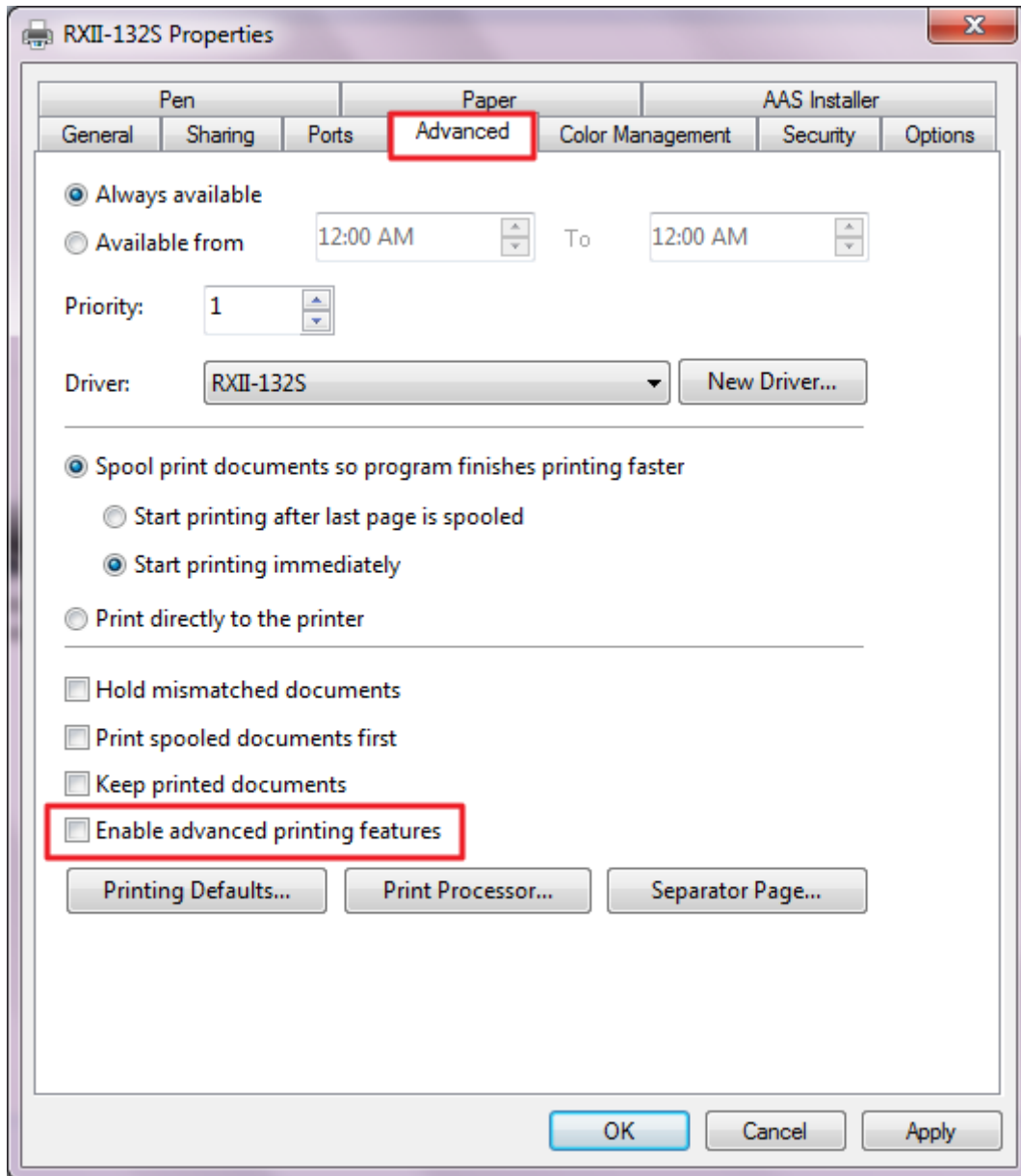

User Instructions

Step 1 Open Illustrator.

Step 2 Edit your image and create a contour line (**Note:** you must have the line width set as 0.001mm).

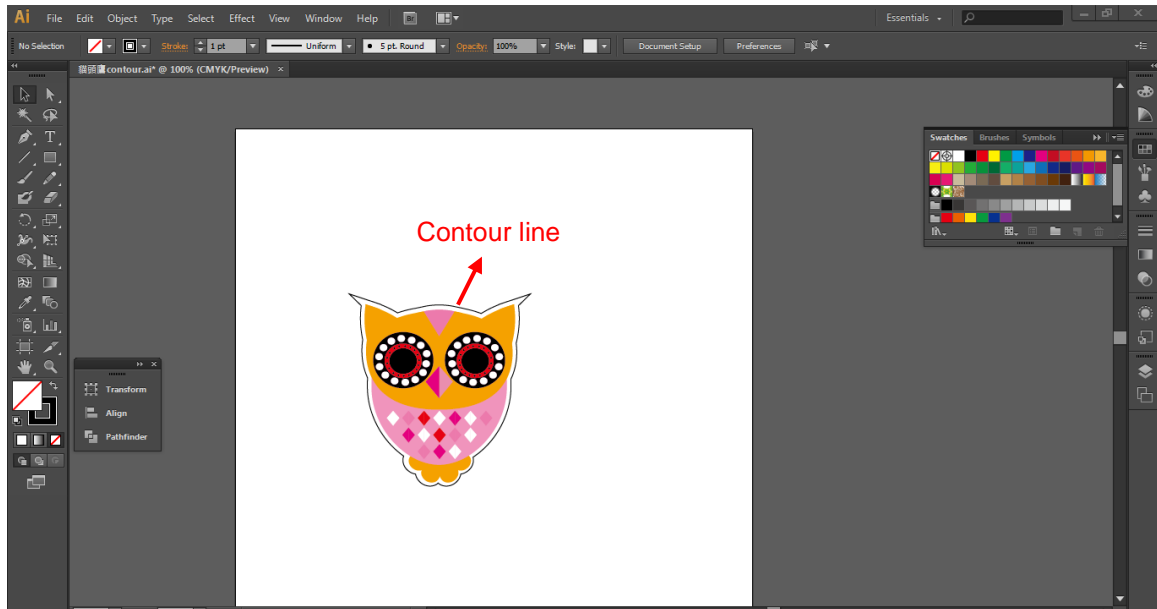

Step 3 Click on the image and apply the AAS function (File→Scripts→_AASII_Plug_In).

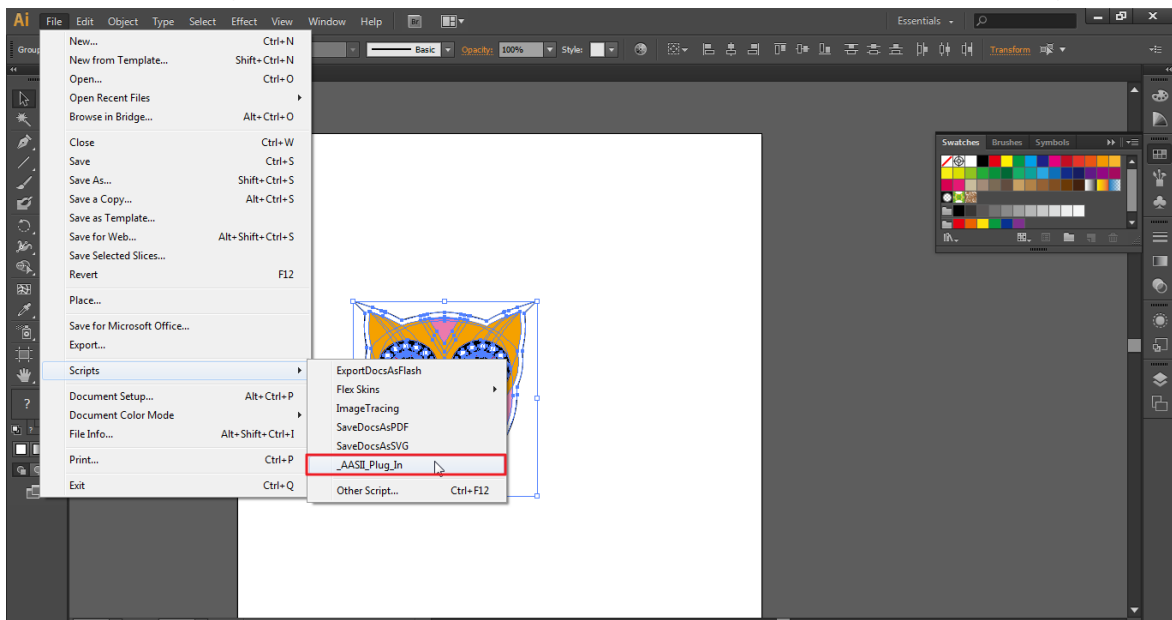

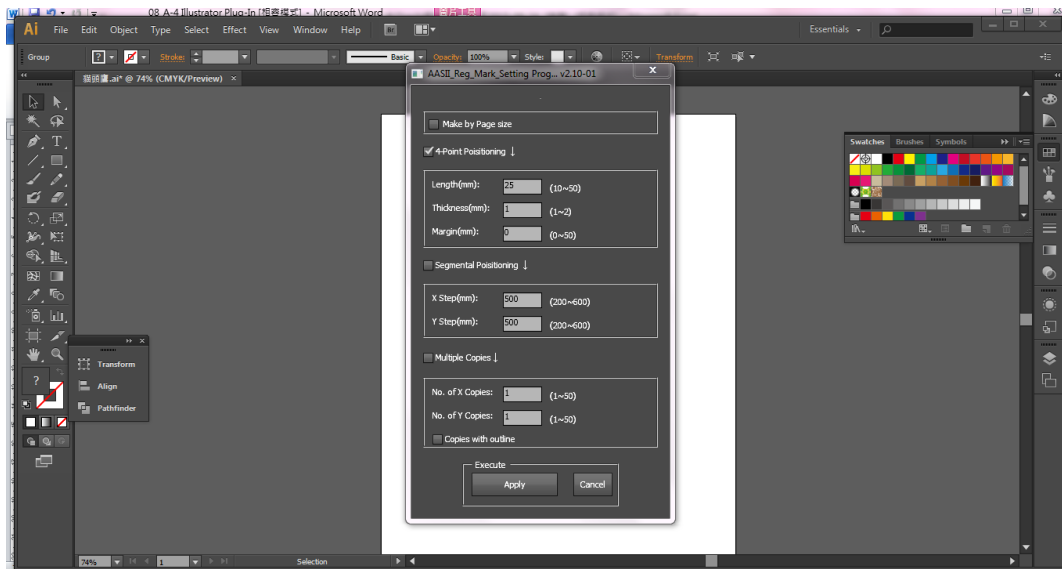
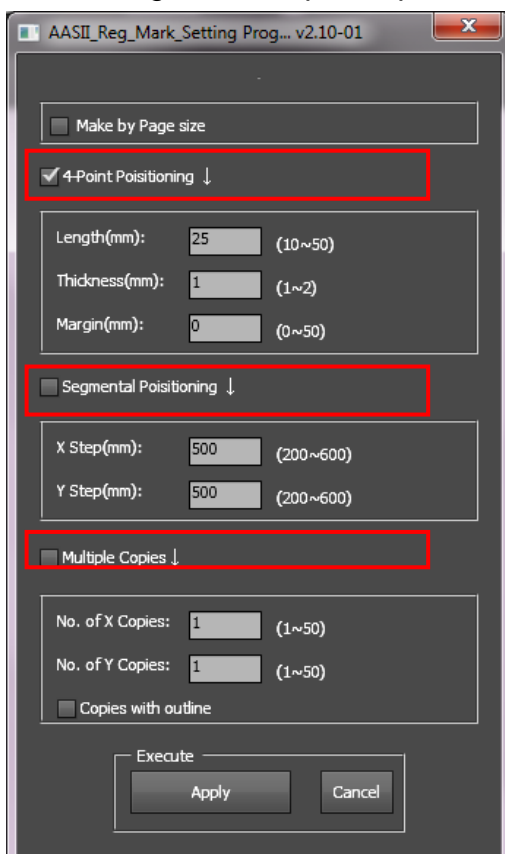
Step 4 Select the registration marks needed**Step 5** Three types of registration marks are introduced here: 4-Point Positioning, Segmental Positioning and Multiple Copies.**Note:**

The values entered in the “4-Point Positioning” section (length, thickness and margin) will still be applied when you tick “Segmental Positioning” or “Multiple Copies.”

Step 6 Confirm the registration marks (the 4-Point Position mark is used as an illustration in the following steps).

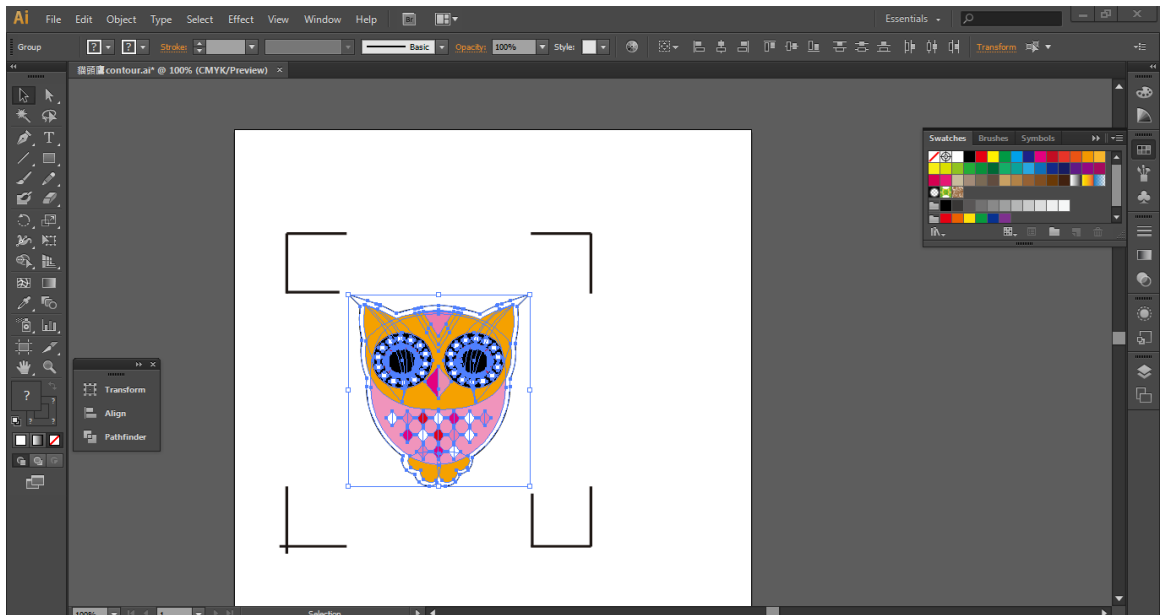

Step 7 Click on the blank area on the page and then click “Document Setup”.

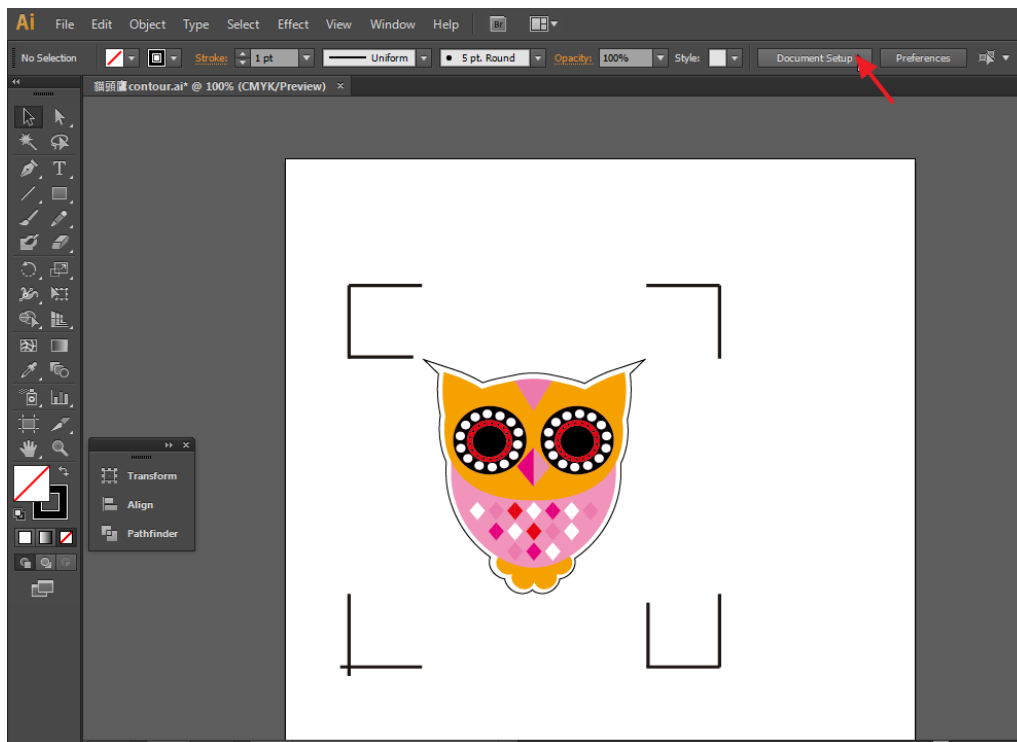

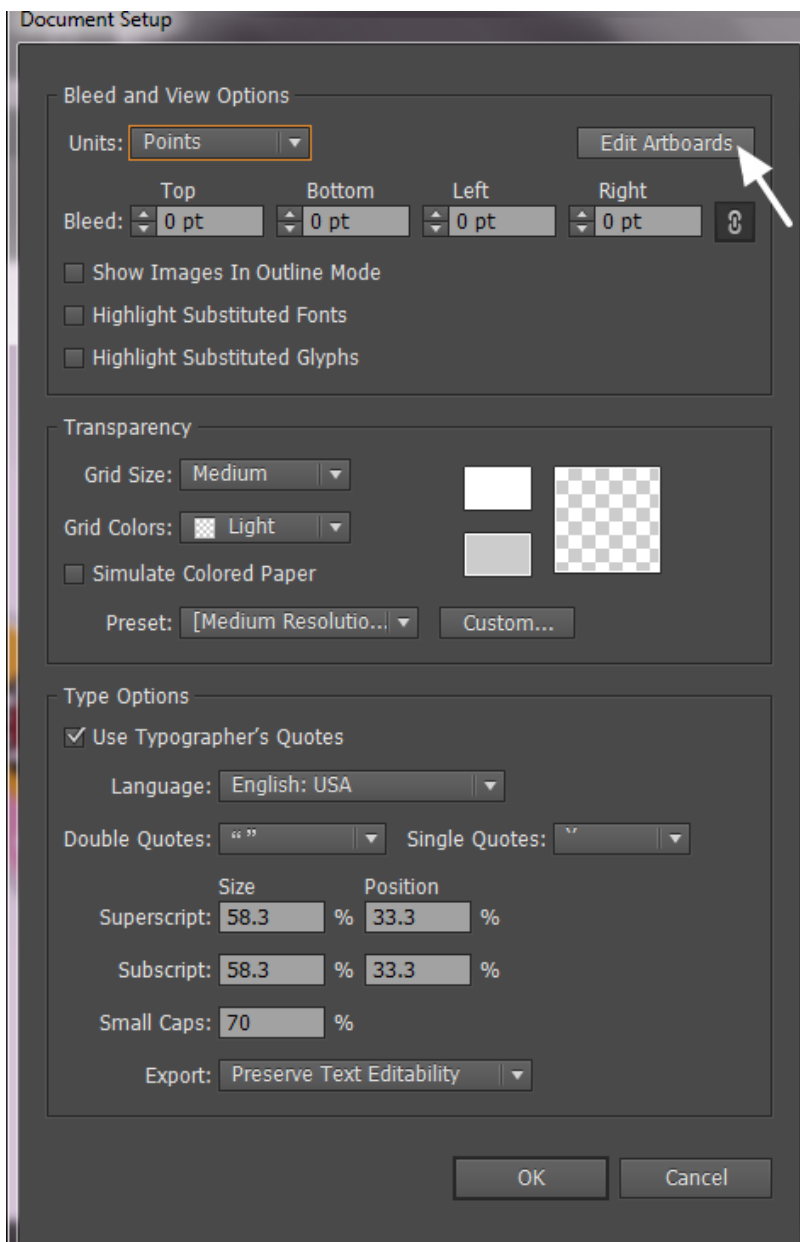
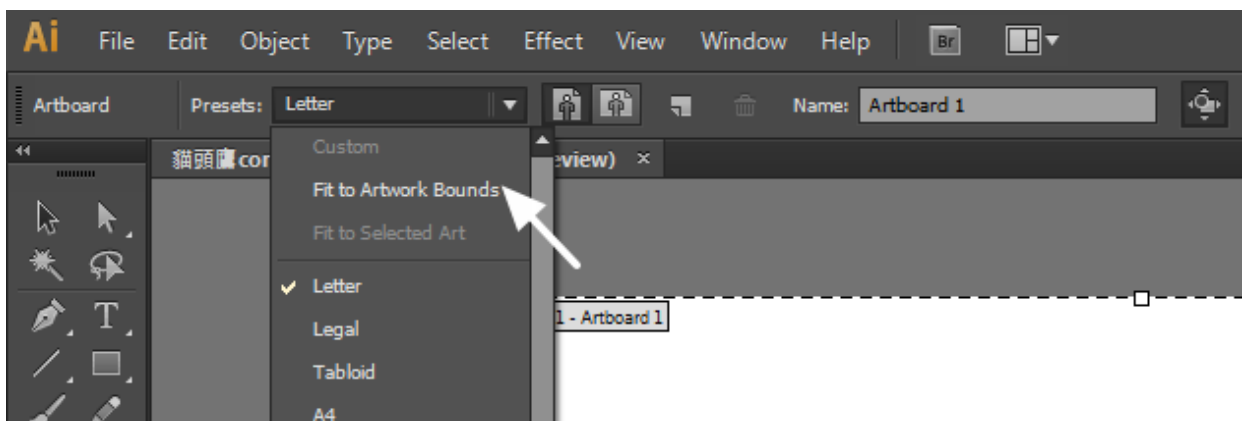
Step 8 Hit “Edit Artboards”.**Step 9** Click on “Presets → Fit Artboard to Artwork bounds”.

Step 10 Please move your mouse to the tool bar on the left when step 9 is finished and then click “Selection Tool”.

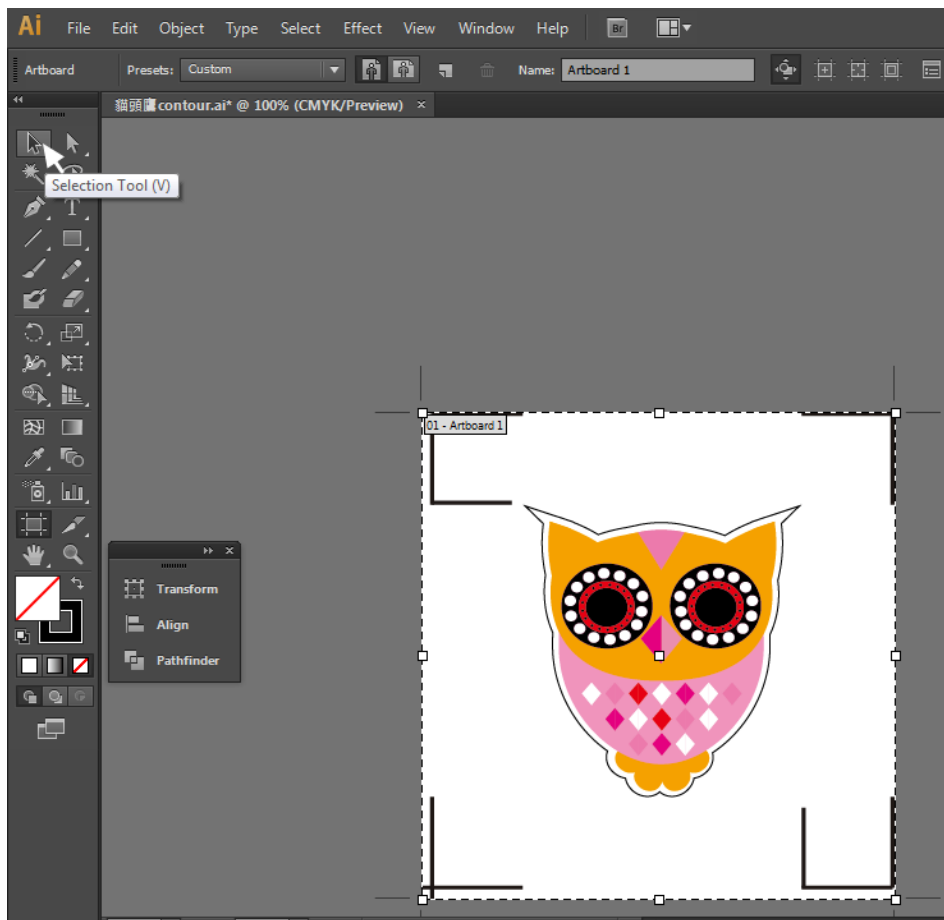

Step 11 This will take you back to the edit mode.

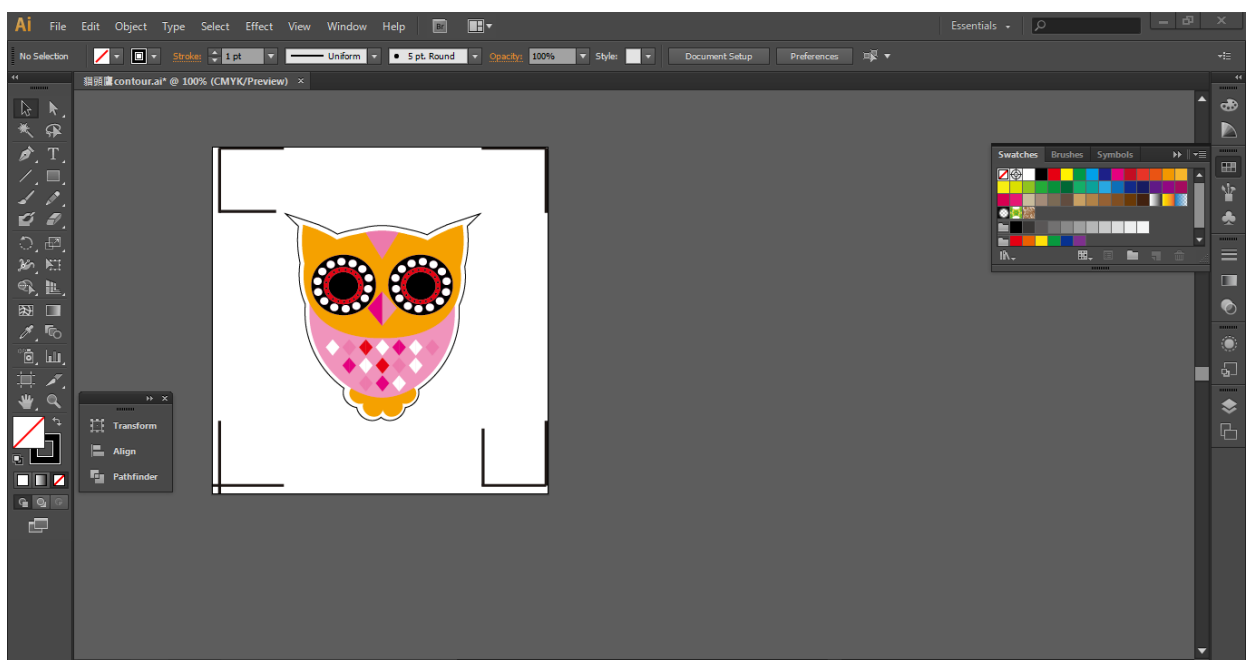

Step 12 Print out the file with the contour line and the registration marks.

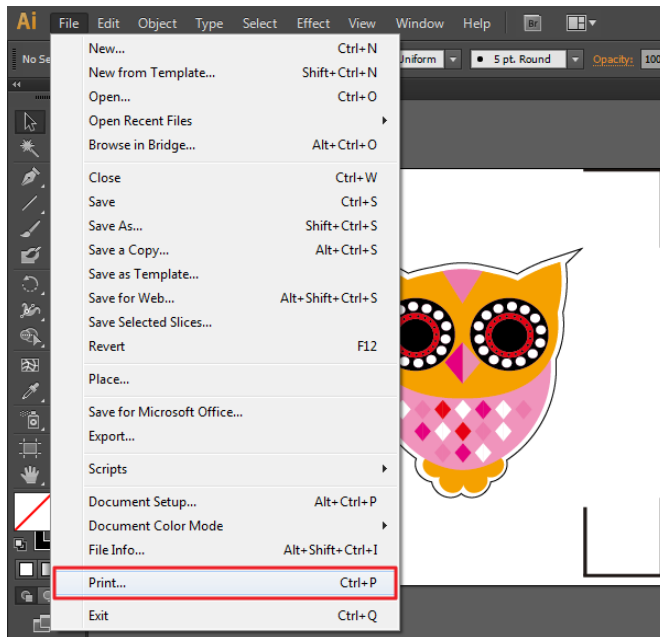

Step 13 Place the printed file on the cutter, lower the pinch rollers and then position the carriage at the origin of the registration marks.

Step 14 Send the file to the cutter.

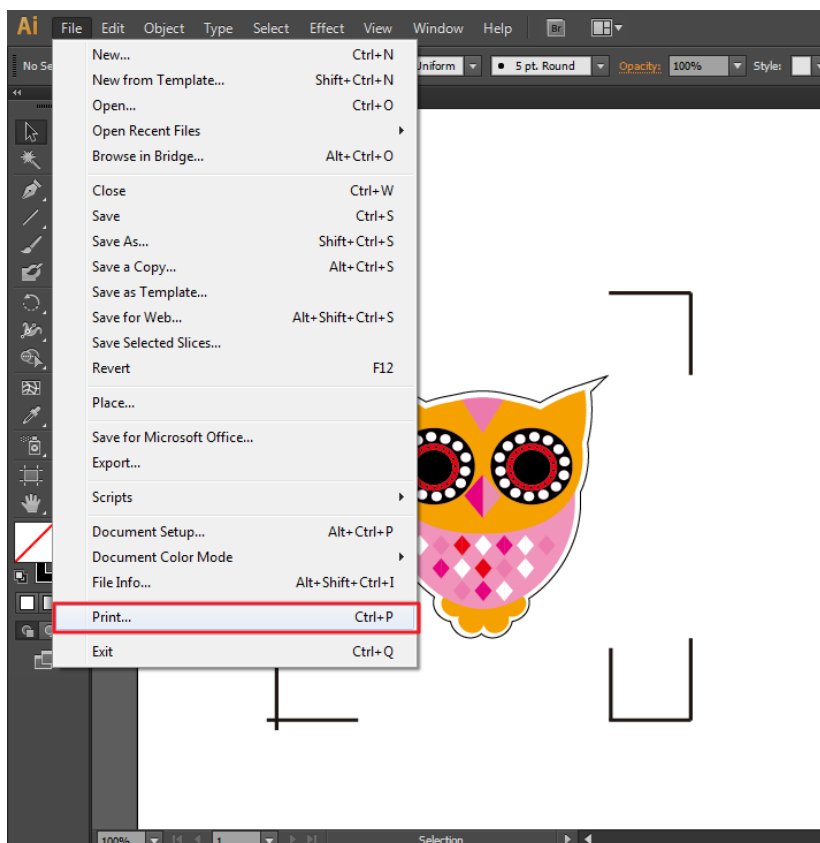

Step 15 Select the cutter model, position the object in the bottom left corner.

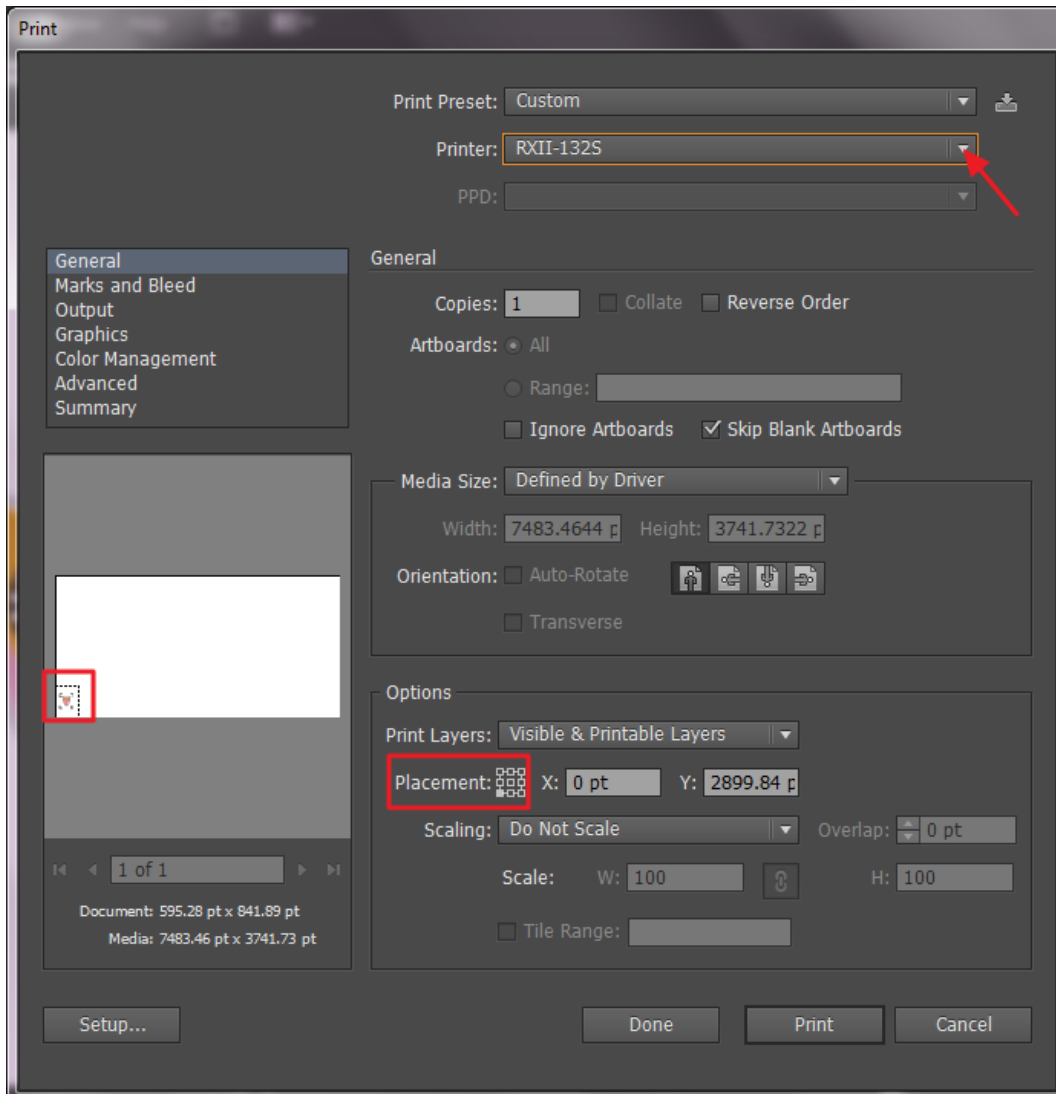

Step 16 Your job is now completed.

Add Registration Mark by page size

If you want to create registration mark by page size, select the object, go to “Scripts” under “File” and select “_AASII_Plug_In”

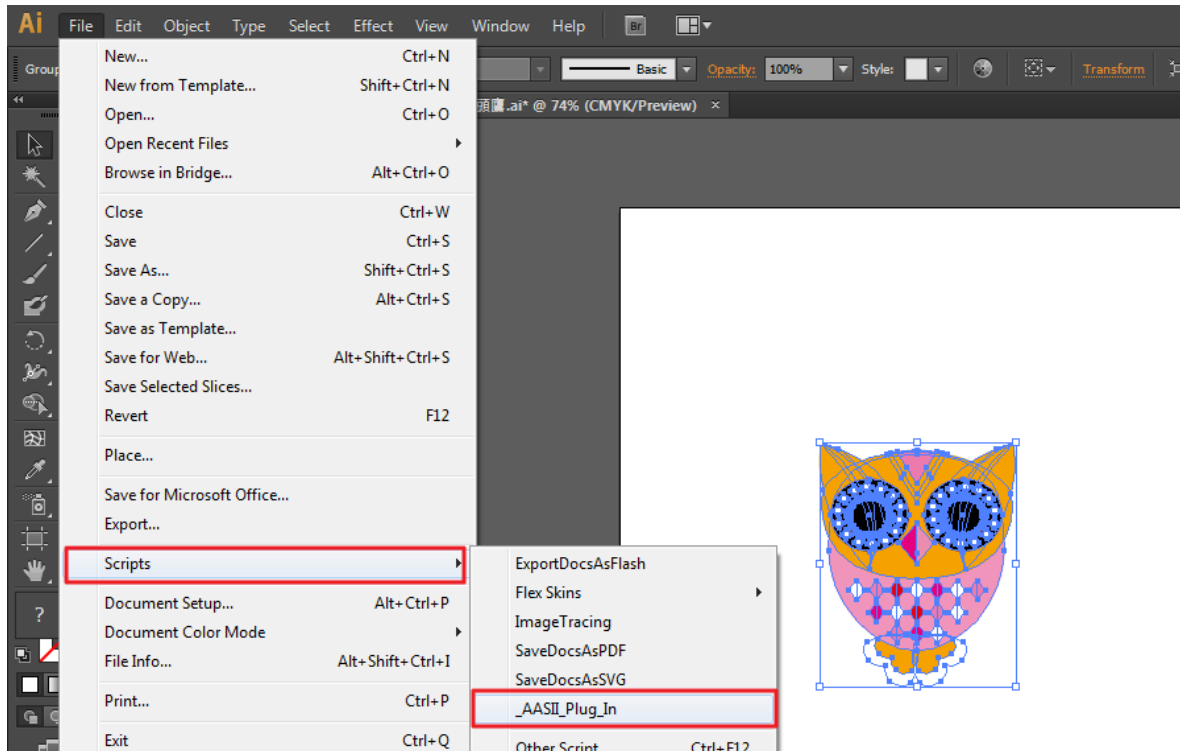

Tick “Make by page size” and click “Apply” and the registration mark will be created on the 4 corners of the page automatically, shown as below.

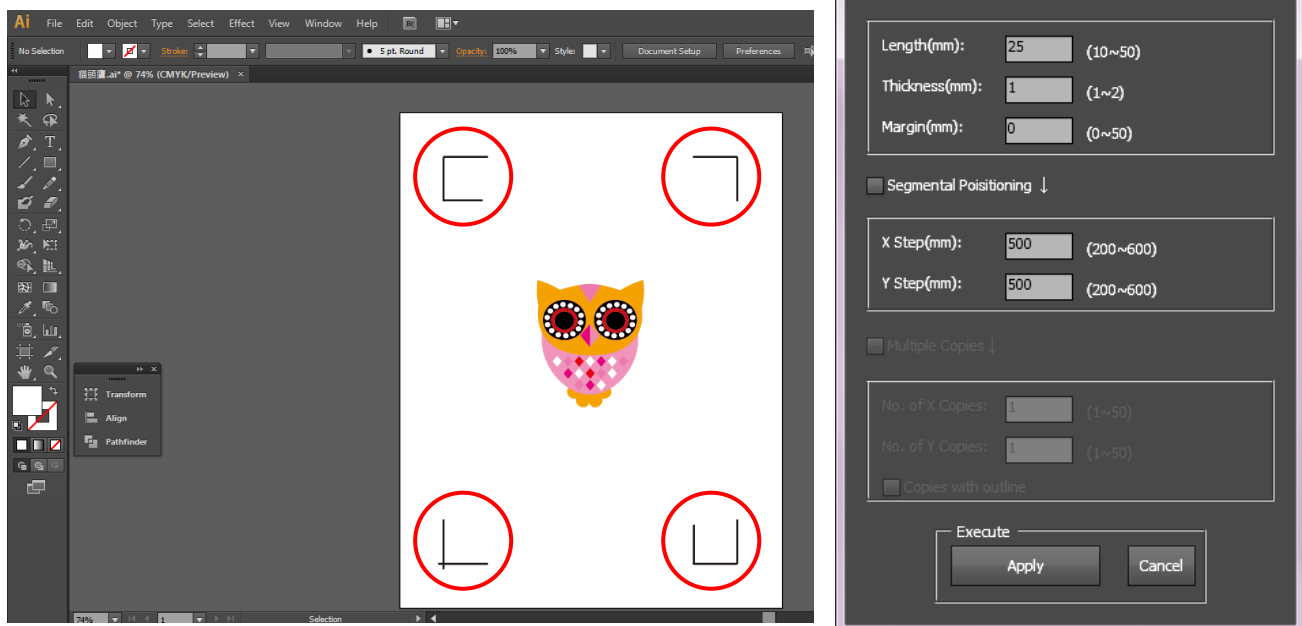

Note:

The length setting will be in the range of 10-50mm according to your page size.

Workable area

It allows users to edit and cut graphics in the area outside the registration marks when adding registration marks by page.

For A4 size media sheet, the workable area is 2.5mm extended from the registration mark on left and right sides and 4.5mm extended from the registration mark on top side. On the bottom side, it is suggested to leave at least 25mm margin from the edge of media sheet to prevent sheets dropping or any error occurred while media sizing.

For A3 size media sheet, the workable area is 10mm extended from the registration mark on the left side, 9mm extended from the registration mark on the right side and 11mm extended from the registration mark on top side. On the bottom side, it is suggested to leave at least 25mm margin from the edge of media sheet to prevent sheets dropping or any error occurred while media sizing.

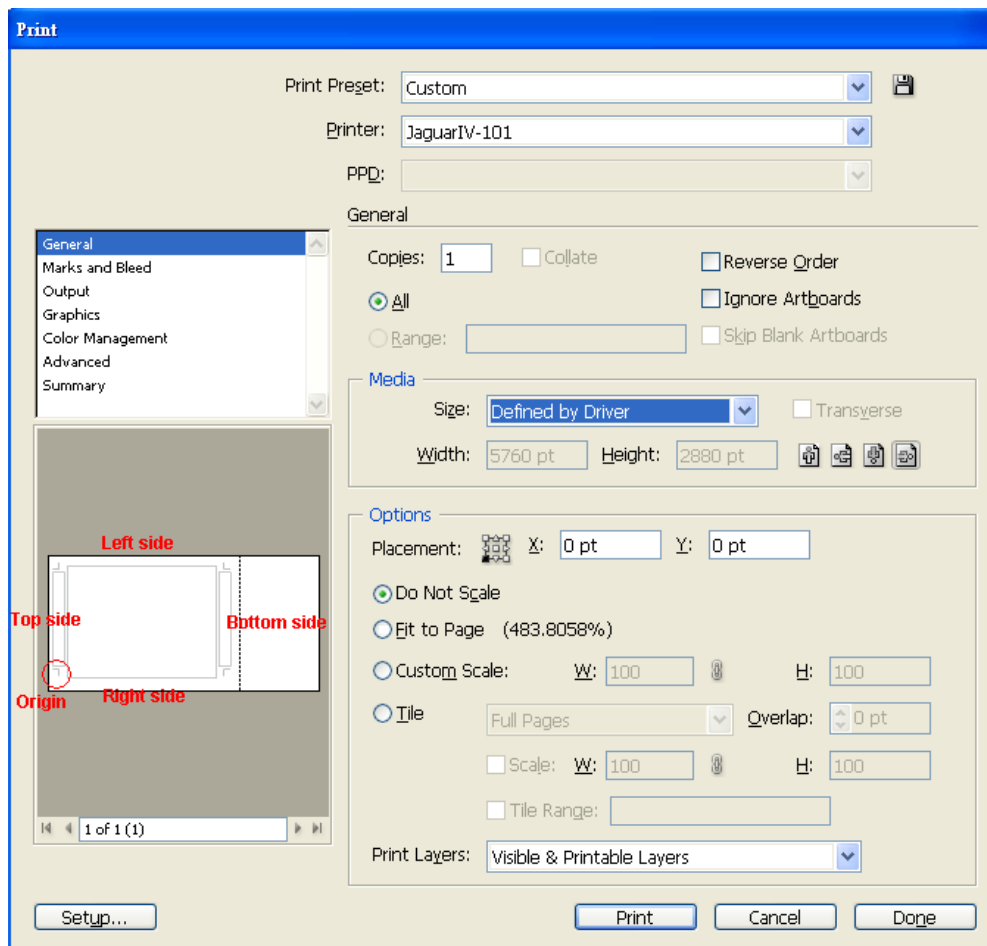

Note: Select “Edge” mode when media sizing to allow the media sheet to be unrolled. If you select “Single” mode, the media sheet will not be able to be moved back and hence fail to be detected by front paper sensor.

Add Registration Mark by Object

If you add registration mark by Object, you will be offered three options of registration marks.

Firstly, select the graphic which you want to add registration mark on and go to “Scripts” under “File” and select “_AASII_Plug_In”.

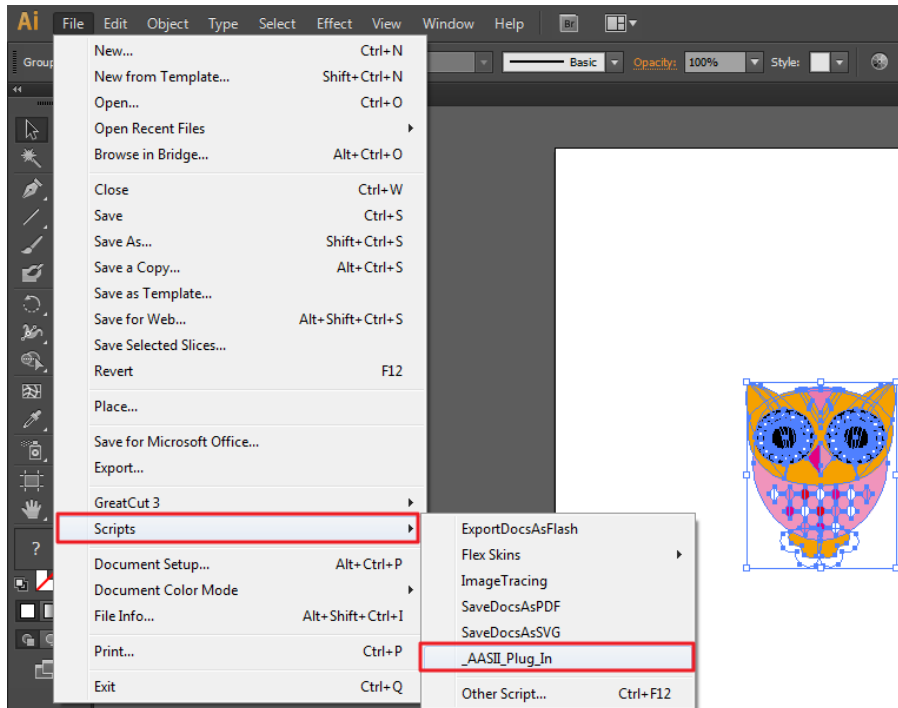

Make sure to untick “Make by page size” and choose one of the registration mark types whichever is suitable.

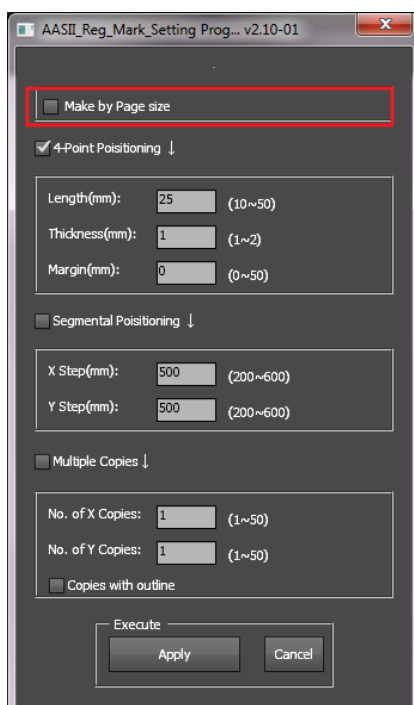

Three types of registration marks

4-Point Positioning

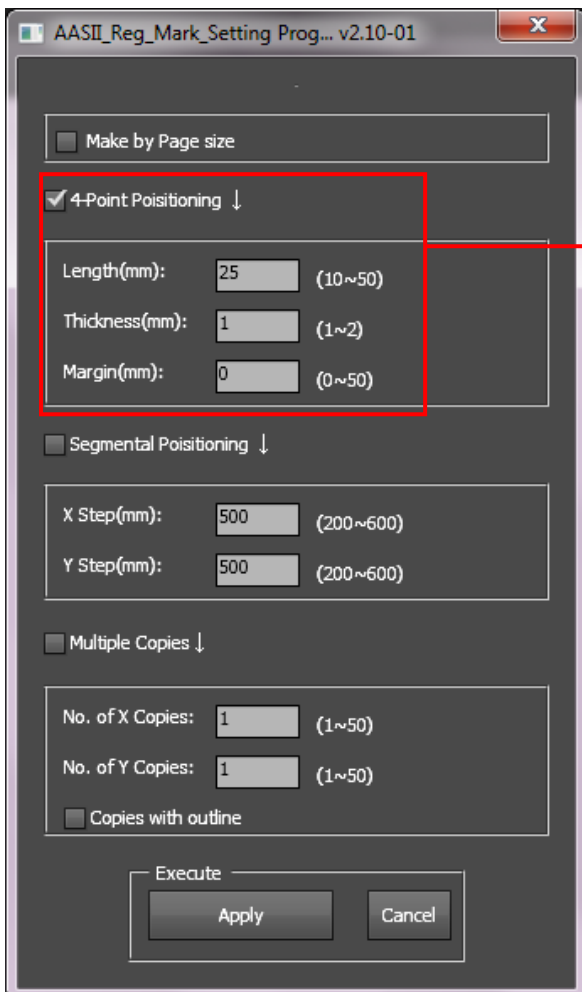

4-Point Positioning

- Length: The length of marks
→ Range: 5mm~50mm
→ Optimized Setting: 25mm
- Thickness: The line thickness of marks
→ Range: 1mm~2mm
→ Optimized Setting: 1mm
- Margin: The distance between marks and images
→ Range: 0mm~50mm
→ Optimized Setting: 5mm

The system will create the 4 marks as shown in the picture below.

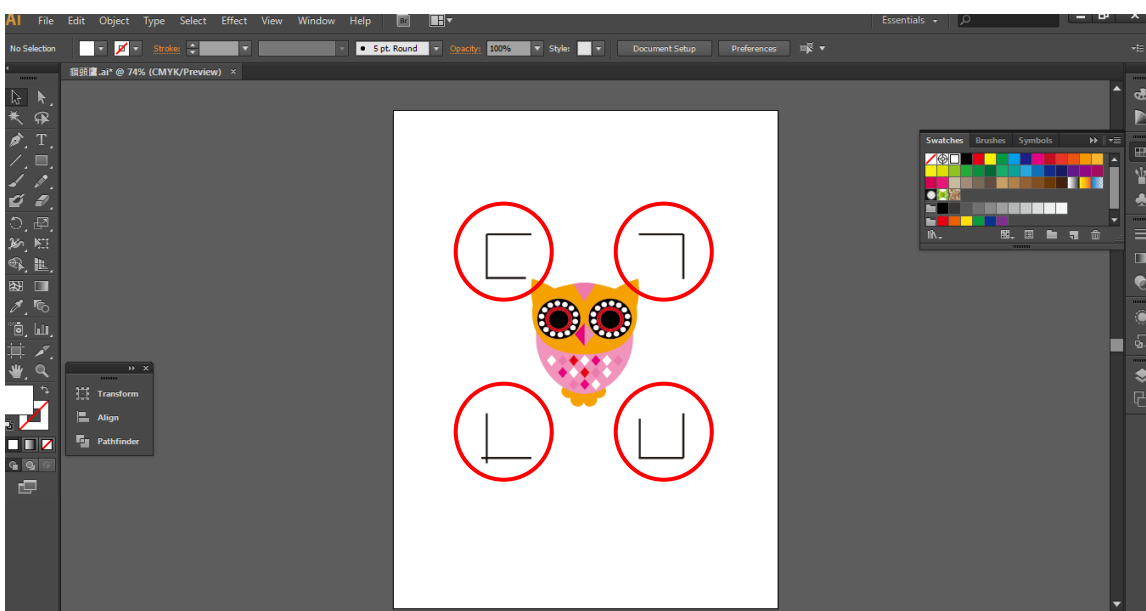

Note:

- To save your materials, in addition to amending object margins, you can also adjust the length of the registration marks (5mm minimum) when you apply 4-Point Positioning (see table 1 for suggestions based on different material sizes). The smaller the size is, the smaller the distance between the object and the registration marks is (see the figures below).

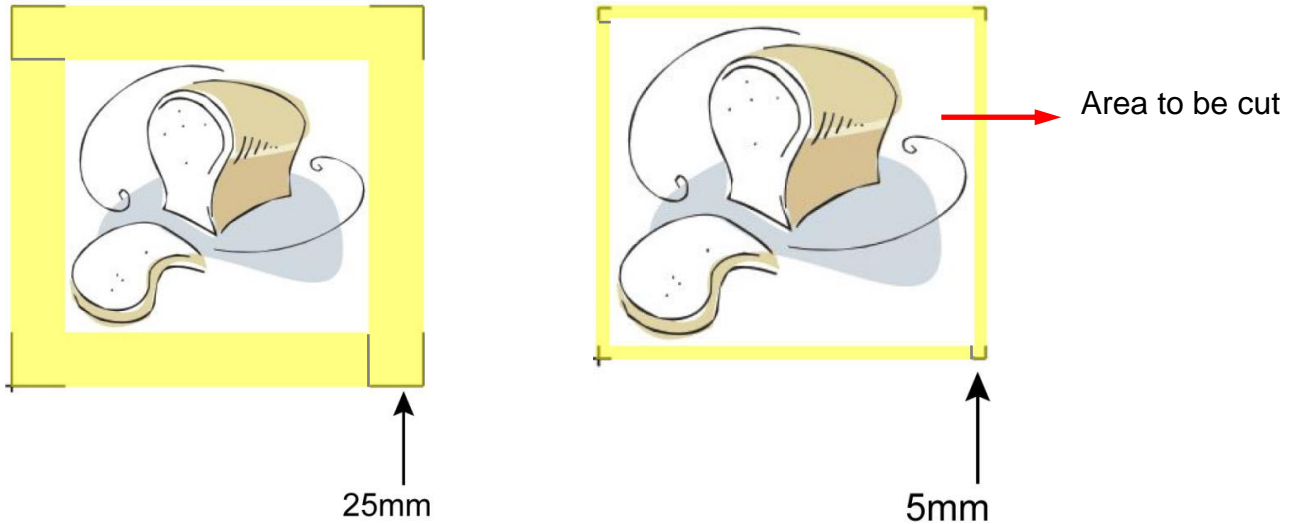

Page size (unit: mm)	Suggested mark length (unit: mm)
A6 (105 x 148)	5
A5 (148 x 210)	8
A4 (210 x 297)	11
A3 (297 x 420)	16
A2 (420 x 594)	23
A1 (594 x 841) and above	25*

Table 1

*25mm is the suggested value for the registration mark length

- The size of the registration marks would affect the accuracy of registration mark detection so please make sure the amount you enter is reasonable.
- If you change the paper size, you will have to reset the registration marks otherwise the previous setting will be applied.

Segmental Positioning

For precise cutting quality, it is suggested to select “Segmental Positioning” when you are working on an extra long or large-sized image to increase cutting accuracy.

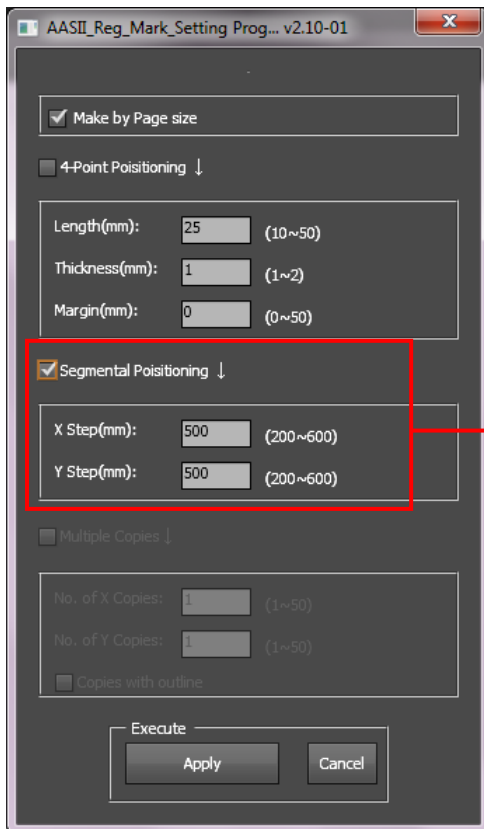

Segmental Positioning

- X Step: The distance of intermediate position on the X axis
- Y Step: The distance of intermediate position on the Y axis
 - Range: 200mm~600mm
 - Optimized Setting: Less than 500mm

The system will create the marks as shown in the picture below.

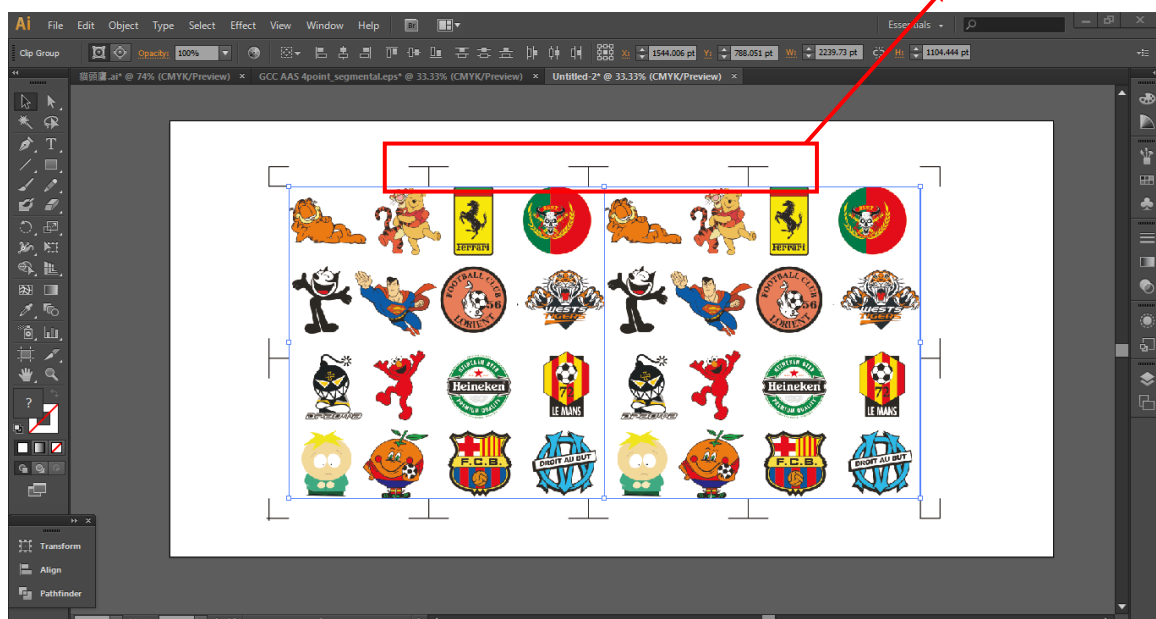

Segmental Positioning

Multiple Copies

It is suggested to select “Multiple Copies” when you would like to make several copies of one image on your material to increase cutting accuracy.

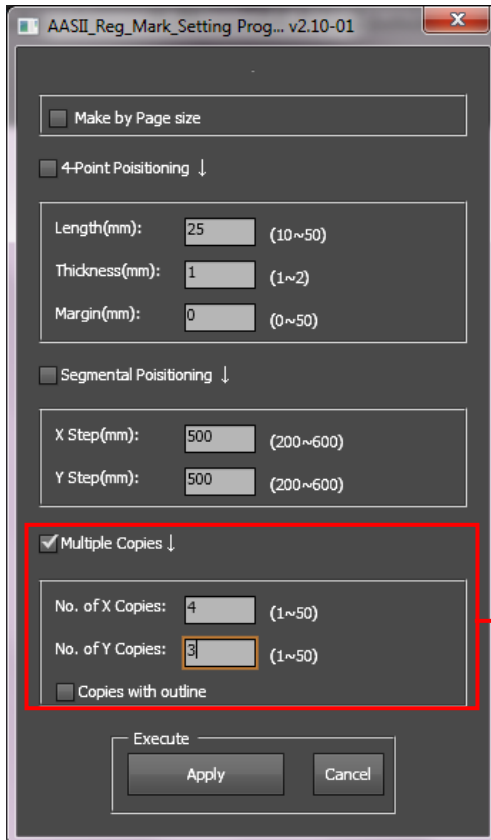

Multiple Copies

- No. of X Copies: The numbers of copies on X axis
- No. of Y Copies: The numbers of copies on Y axis
→ Range: 1~50. (The more copies you make, the more time is needed for data transmission.)
→ Numbers of X Copies * Numbers of Y Copies = The total amount of image copies
- Copies with outline : To show outlines of image graphics
- Margin: Space between marks; must be 0 or ≥ 20 , no negative numbers allowed

The system will create the as shown in the picture below.

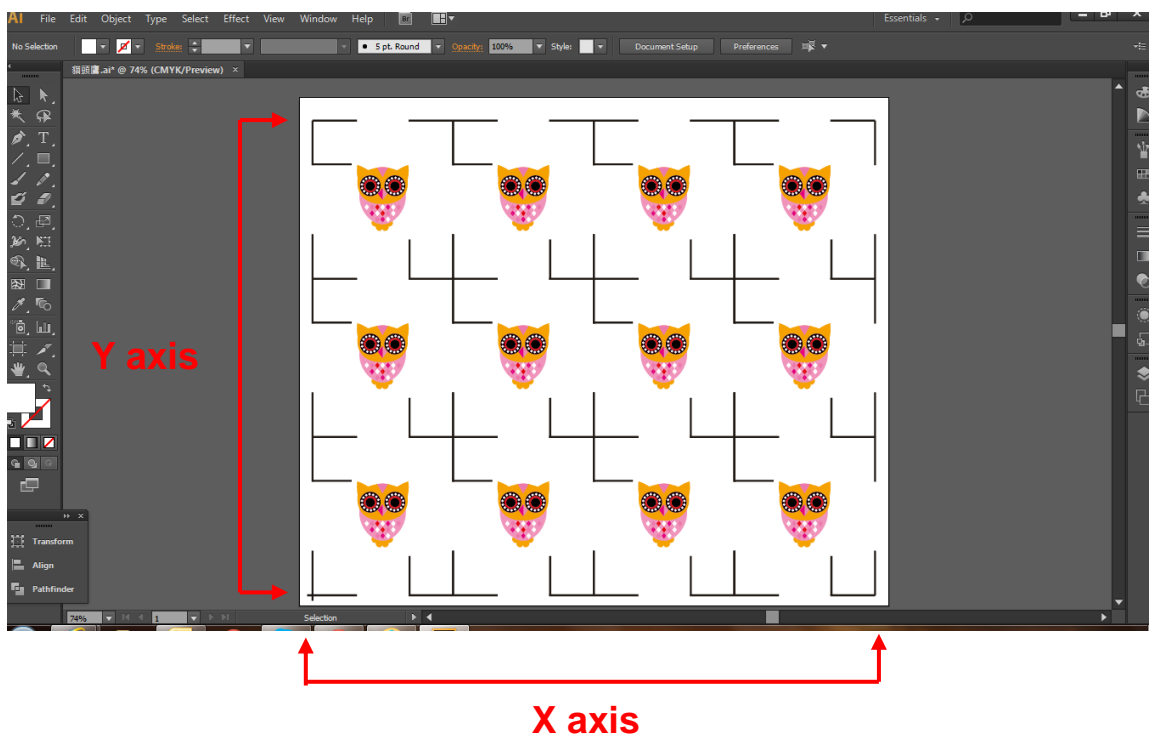

GreatCut Plug-In Instruction

The user manual of GreatCut software is available on the GCC installation DVD.

GCC AASII System

Below is a step-by-step instruction of using the AAS function in GreatCut software through CorelDRAW and Adobe Illustrator.

Edit your image in CorelDRAW

4-Point Positioning

Step 1 Create a new file in CorelDRAW and click on the Create contour icon on the GreatCut toolbar (it would appear automatically once CorelDRAW is open).

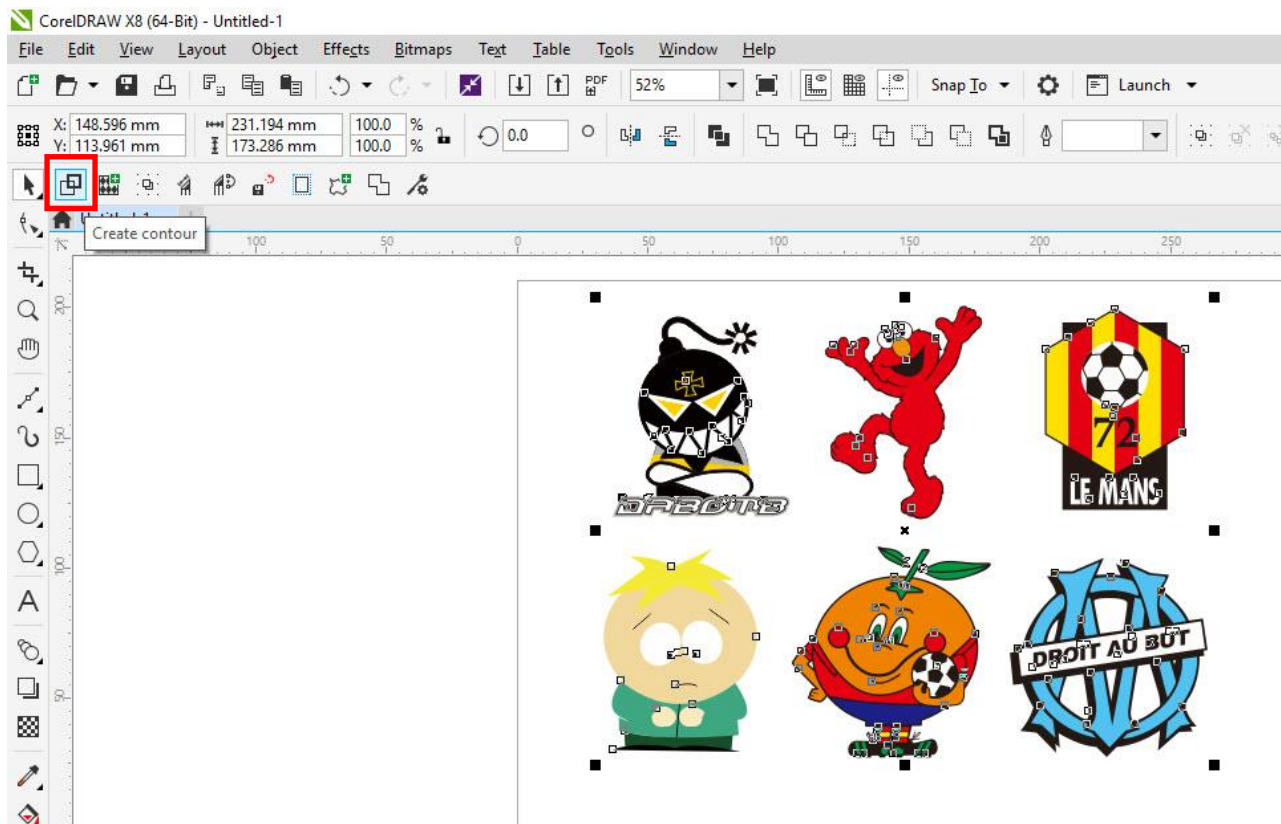

Step 2 Complete contour line settings (including contour offset value) and press Calculate to confirm.

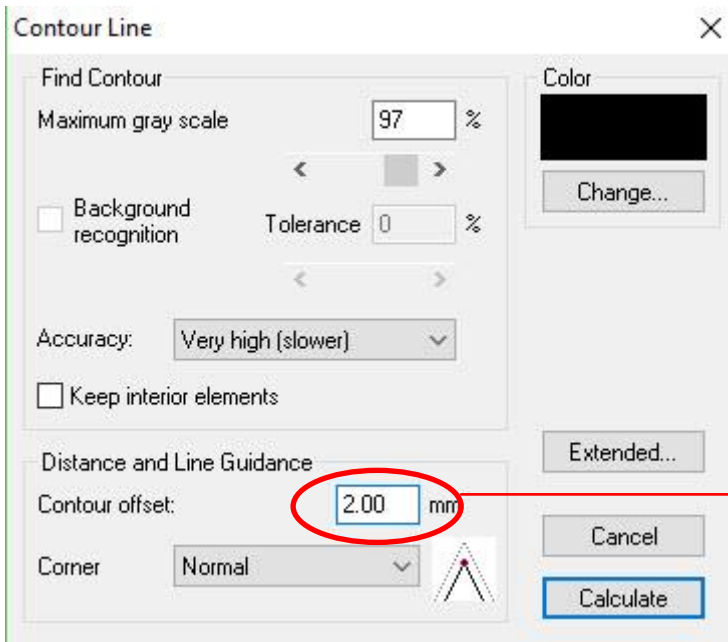

Contour offset is the distance between the object and the contour line.

Contour lines will be added to the images.

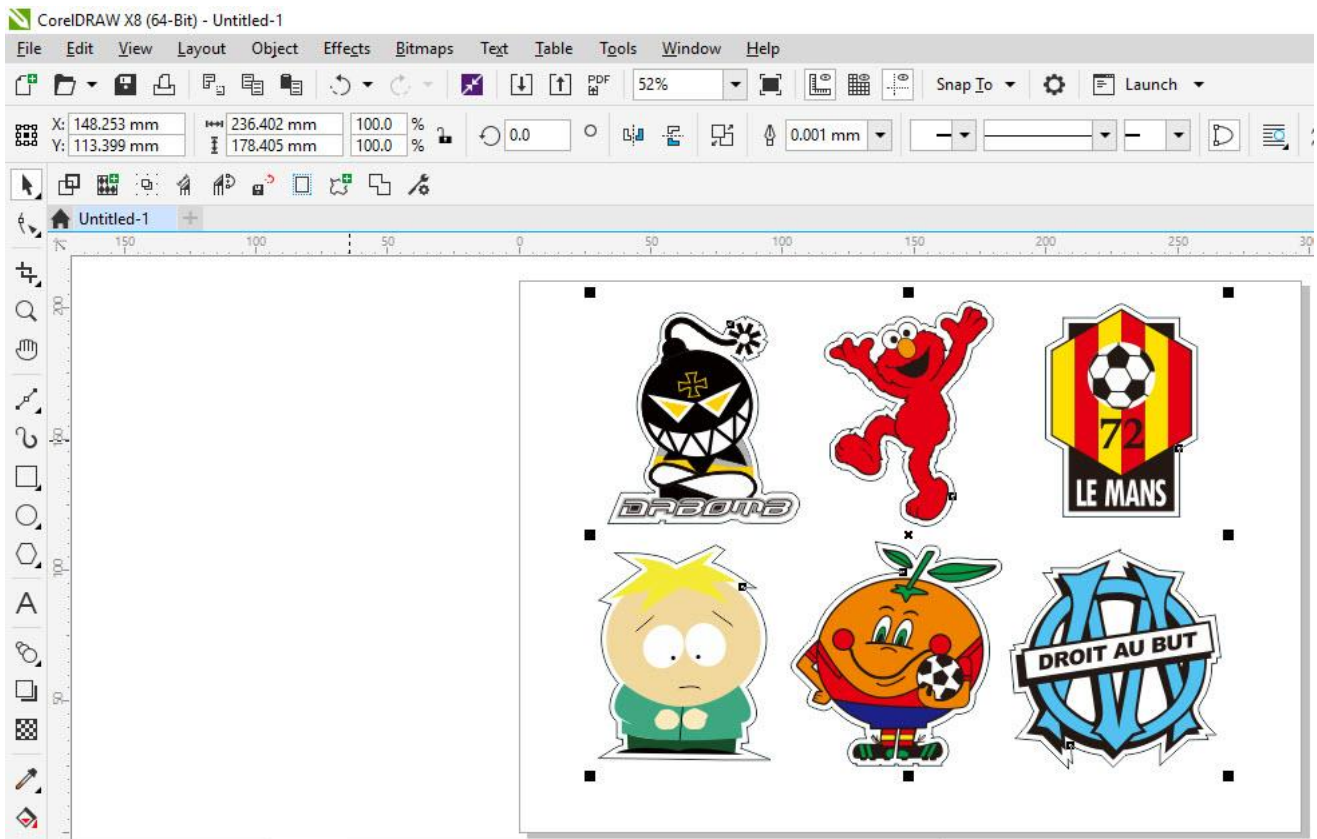

Tips: Vector object to create round outline

In general for vector objects you will get better results with the outline function. You will see the difference between "Normal" and "Round" in sharp corners. The picture is shown as below:

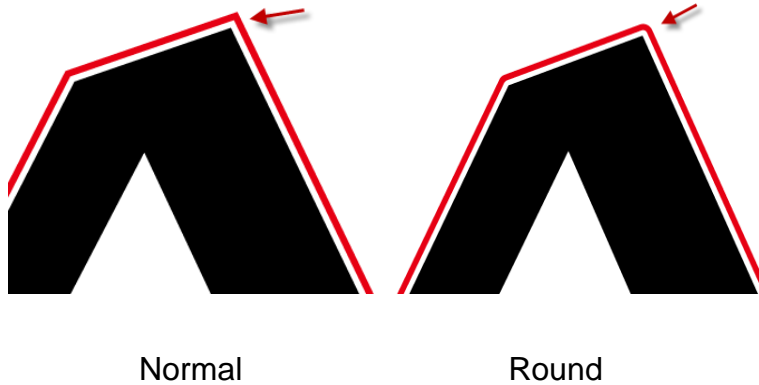

1. Click the "Create outline" to create contours in a freely definable distance around text objects.

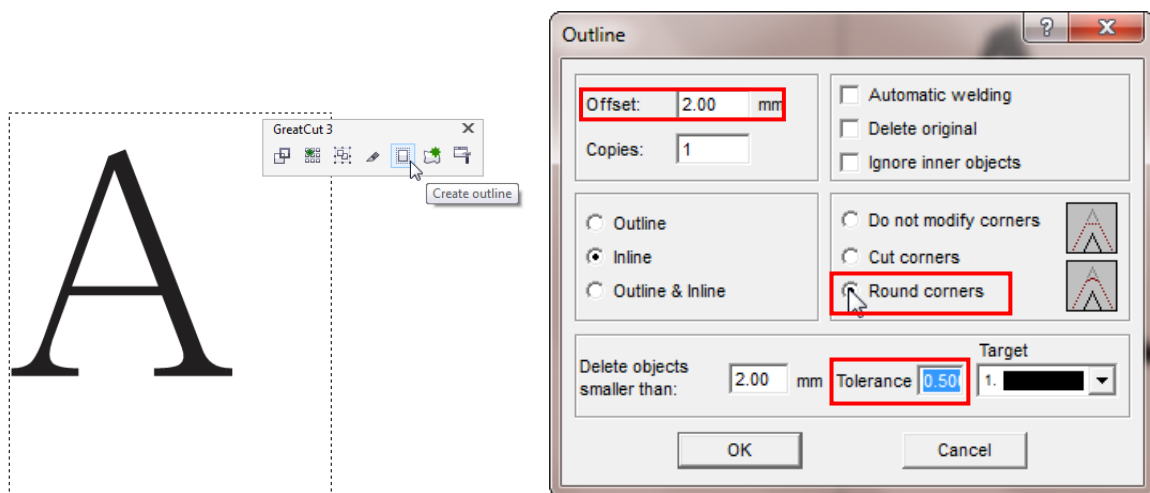

2. Select "Round corners" and set the value of "offset" and "tolerance."

Offset is the value for the distance of the inline and outline from the original object. The field **tolerance** indicates in which offset from the corner dot is cut respectively rounded.

Step 3 Press the Settings icon on the GreatCut toolbar.

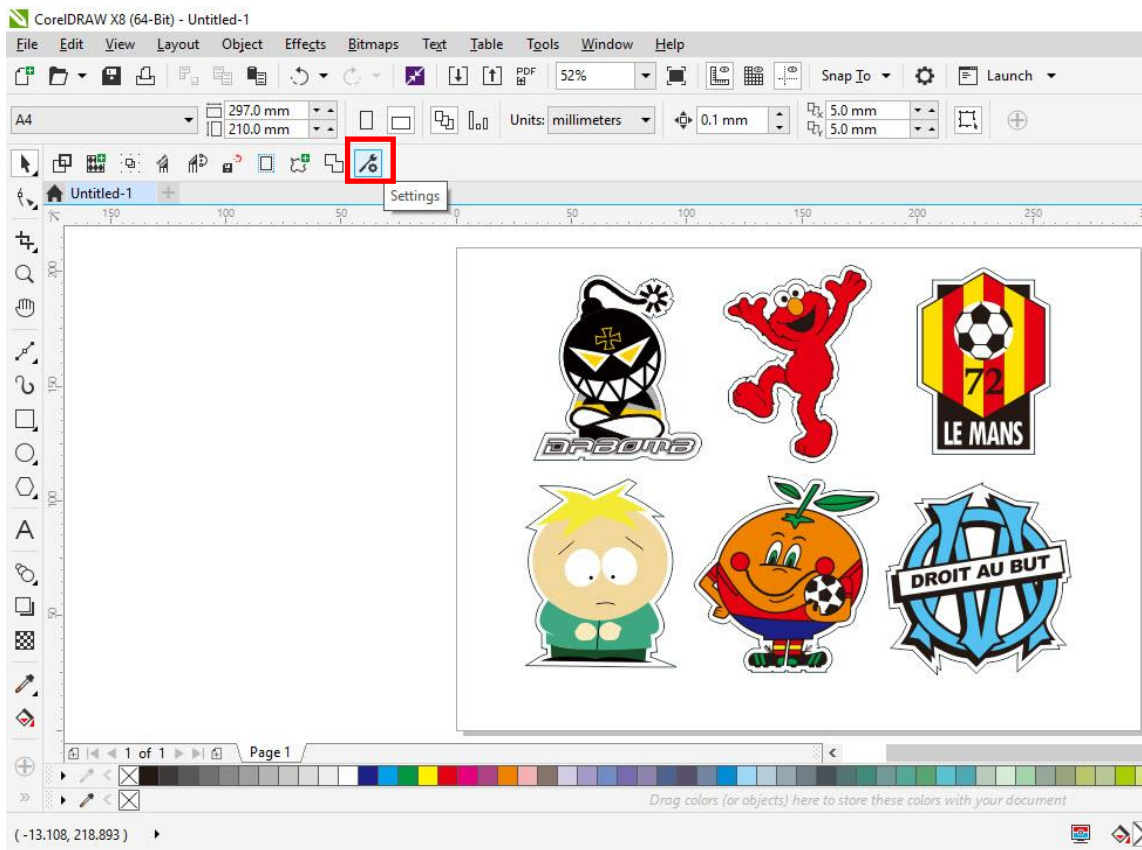

Step 4 Press the button on the right of Jog marks.

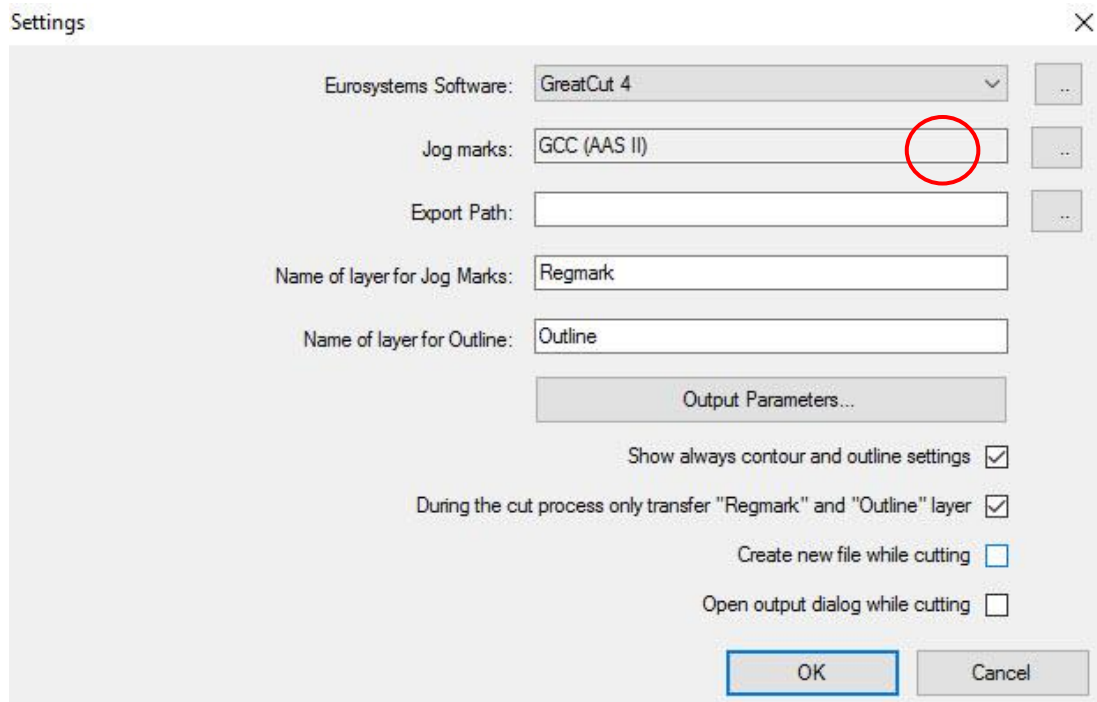

Step 5 Adjust the size, object margin and line thickness of your registration marks in the Setup-Jog Marks window and click OK.

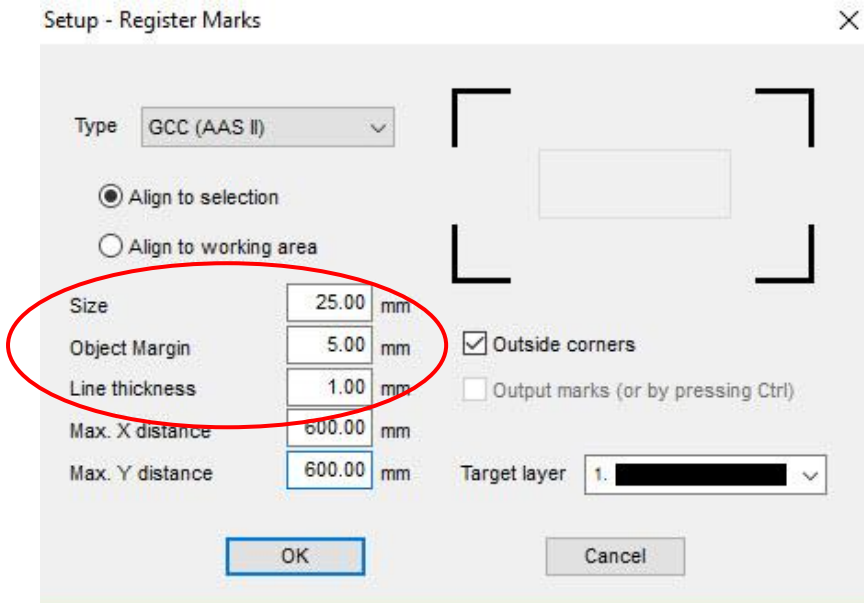

4-Point Positioning

- **Size:** The length of marks
→ Range: 5mm~50mm
→ Optimized Setting: 25mm
- **Object margin:** The distance between marks and images
→ Range: 0mm~50mm
→ Optimized Setting: 5mm
- **Line thickness:** the line thickness of marks
→ Range: 1mm~2mm
→ Optimized Setting: 1mm

Step 6 Ensure the three items below are selected and click OK.

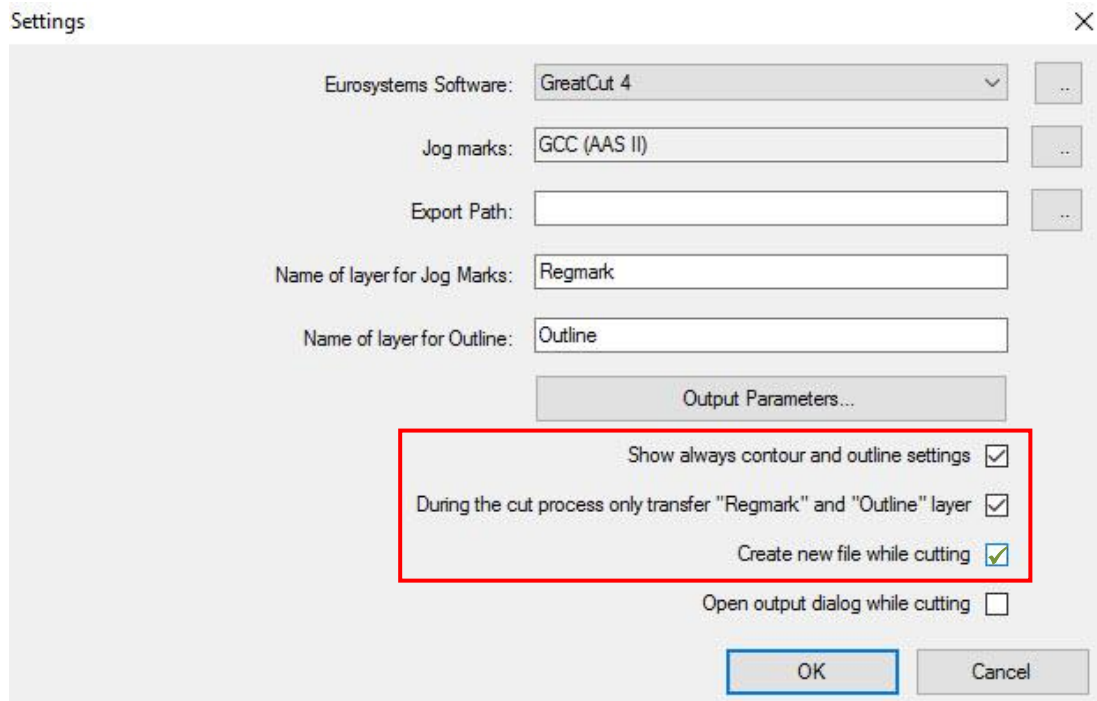

Step 7 Click the Set Jog Marks icon on the GreatCut toolbar.

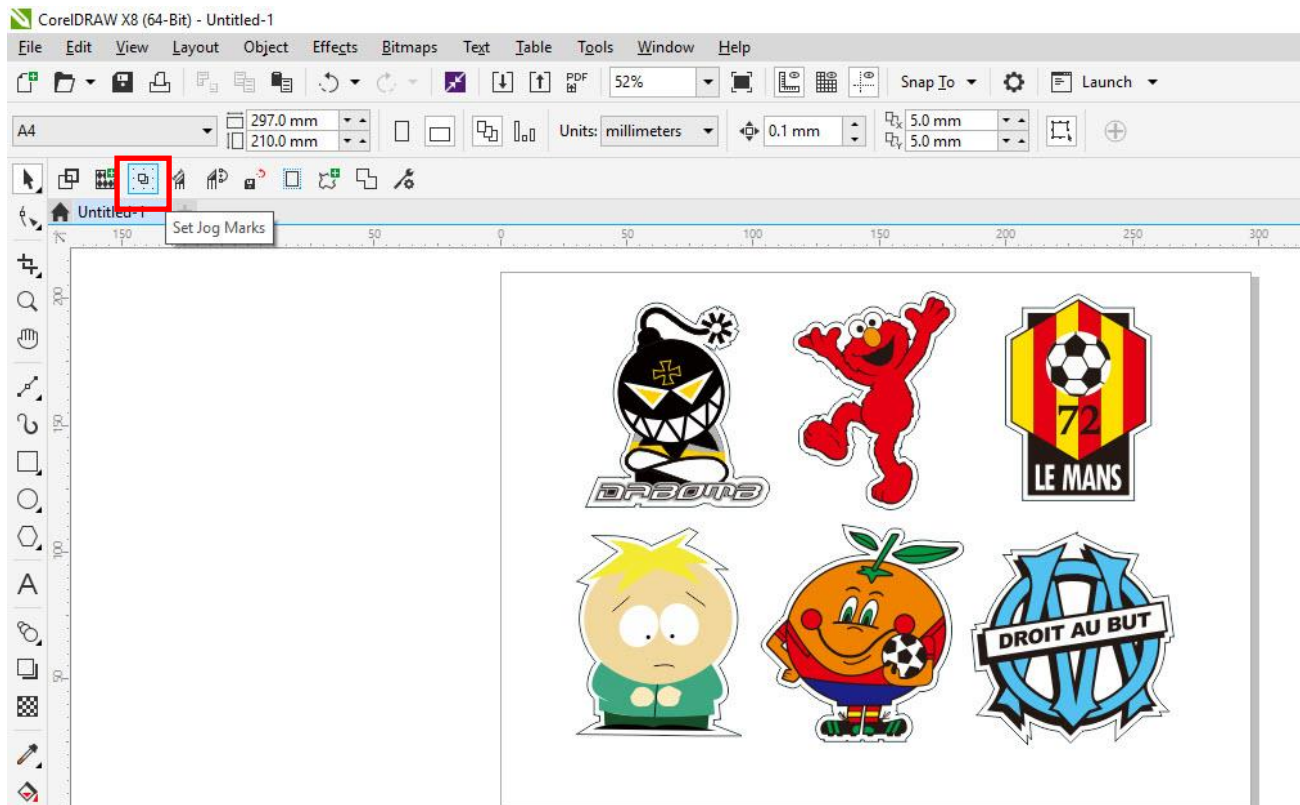

The system will create the 4 marks as shown in the picture below.

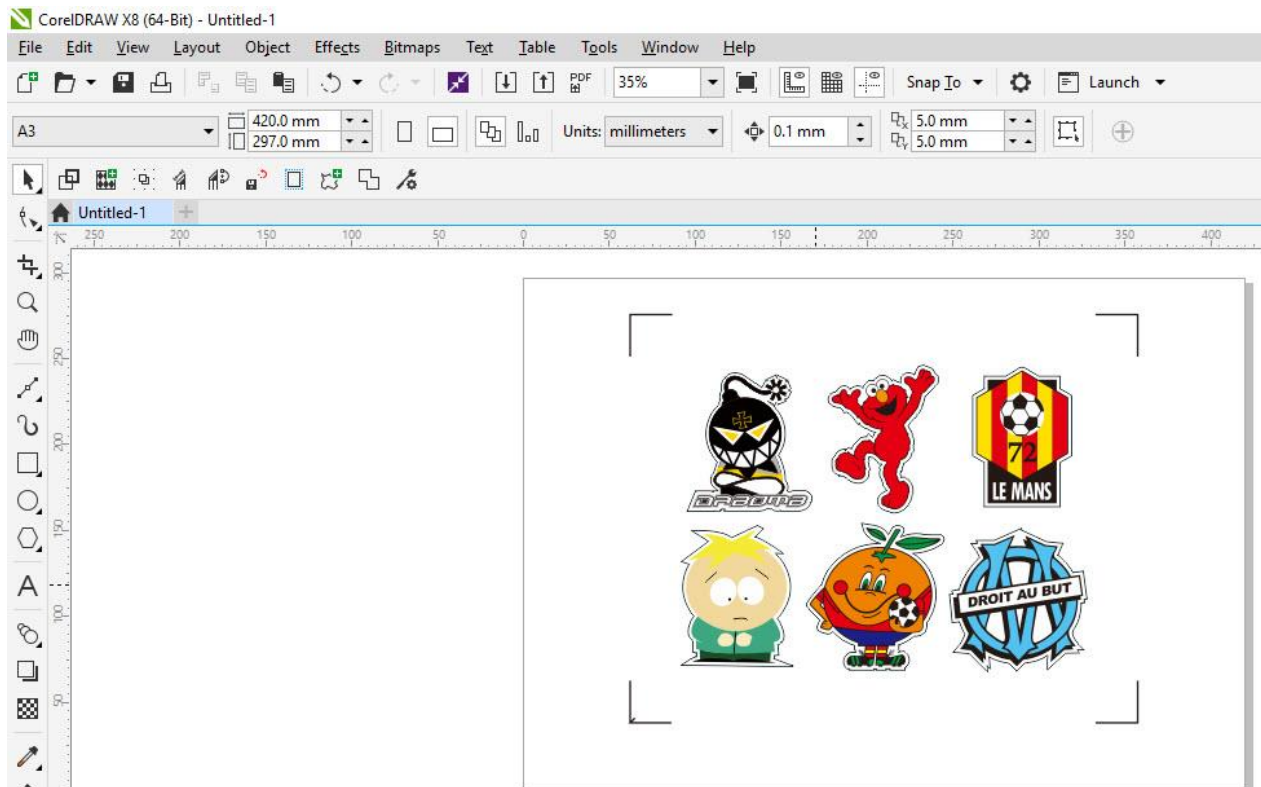

Note:

- To save your materials, in addition to amending object margins, you can also adjust the length of the registration marks (5mm minimum) when you apply the above function(see table 1 for suggestions based on different material sizes). The smaller the size is, the smaller the distance between the object and the registration marks is (see the figures below).

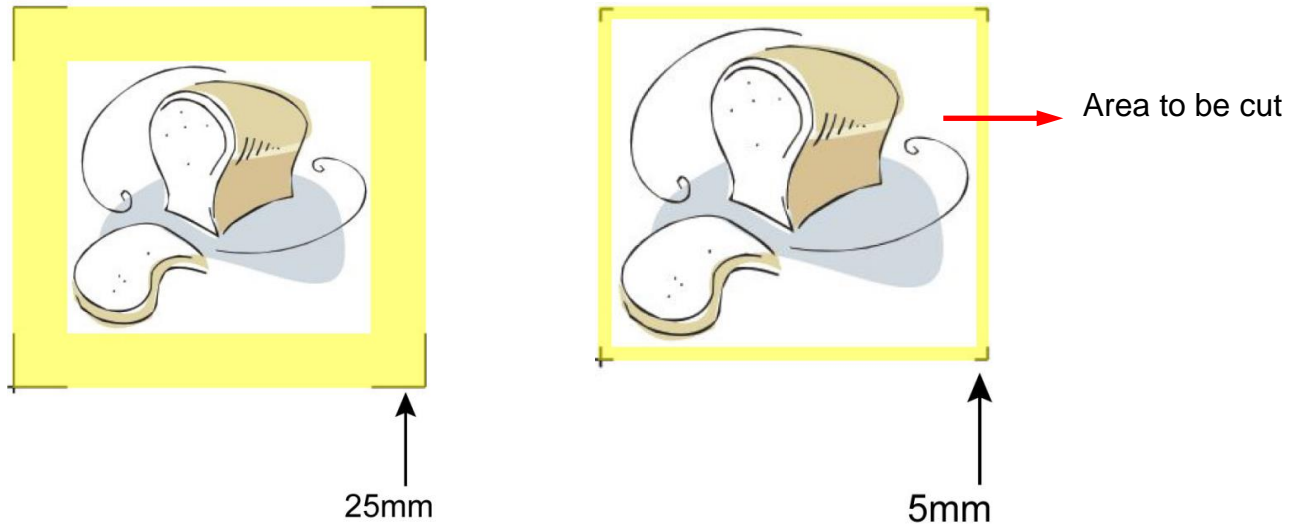

Page size (unit: mm)	Suggested mark length (unit: mm)
A6 (105 x 148)	5
A5 (148 x 210)	8
A4 (210 x 297)	11
A3 (297 x 420)	16
A2 (420 x 594)	23
A1 (594 x 841) and above	25*

Table 1

*25mm is the suggested value for the registration mark length

- The size of the registration marks would affect the accuracy of registration mark detection so please make sure the amount you enter is reasonable.

Output

Step 1 Select both the entire object (including registration marks and the contour line) and press the Cut icon on the GreatCut toolbar.

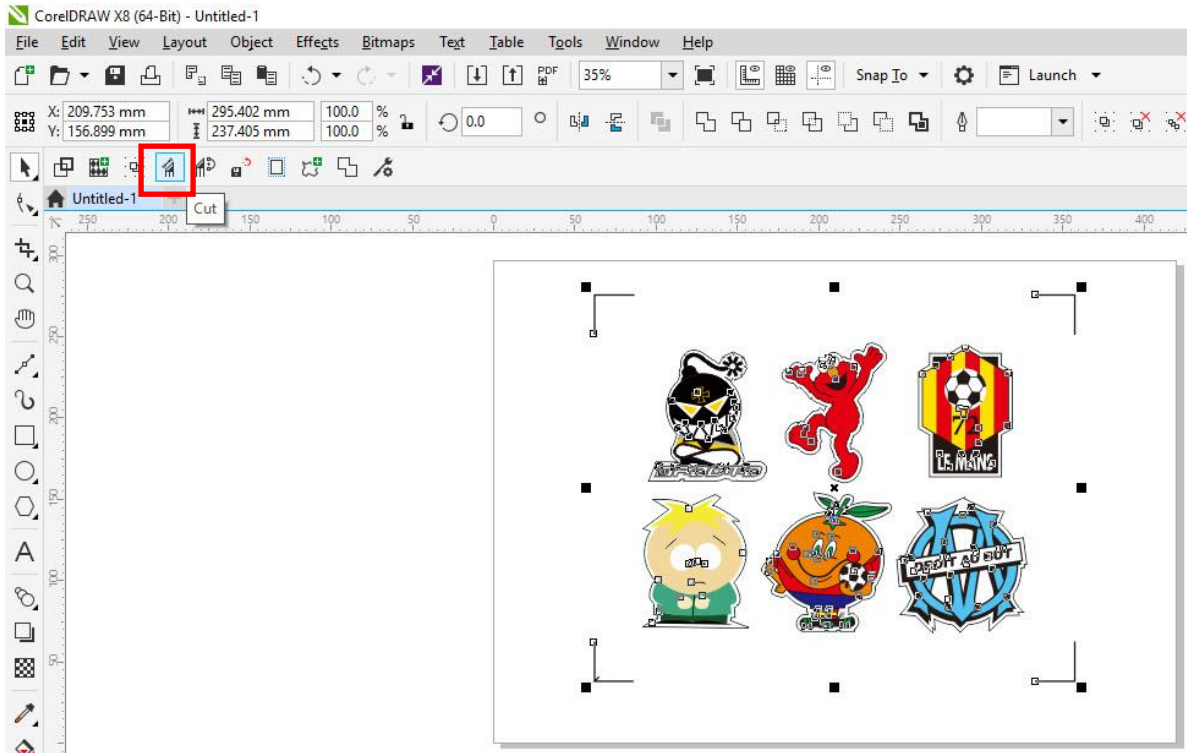

Step 2 The system will activate GreatCut automatically and import the registration marks and contour line to GreatCut.

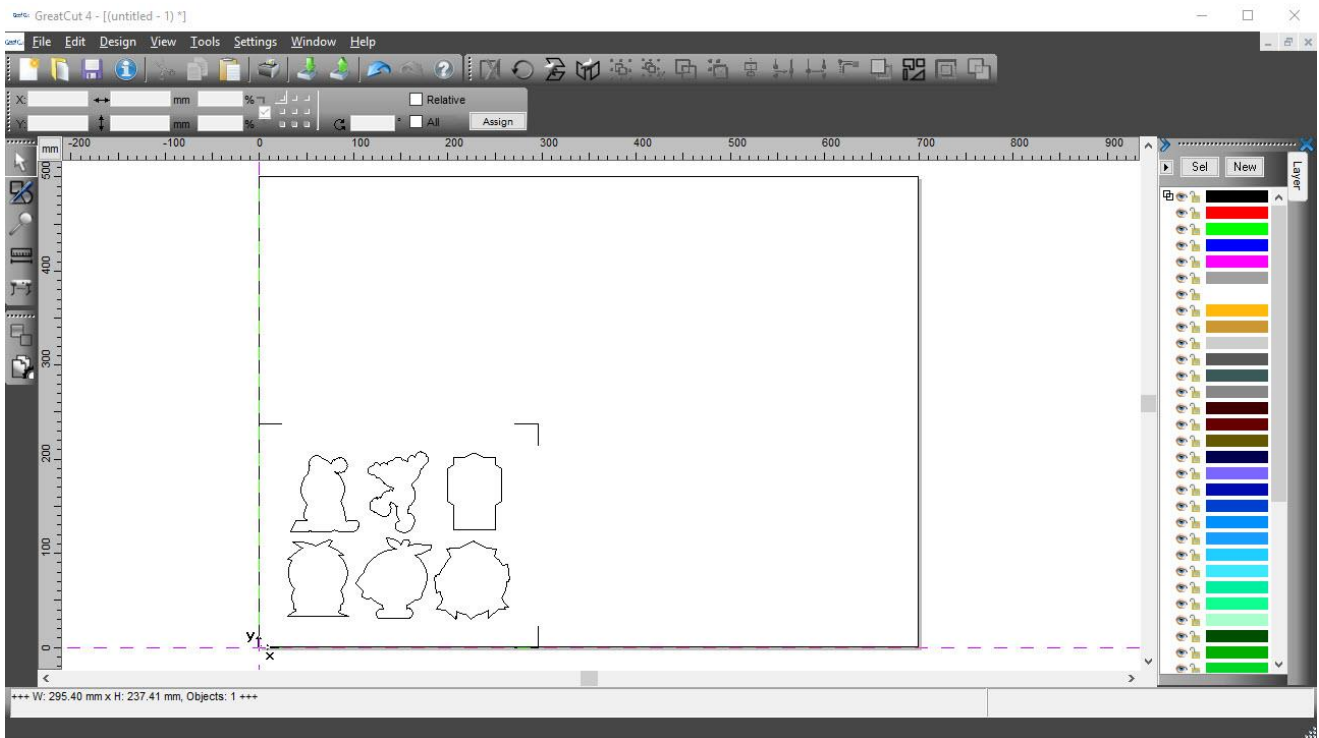

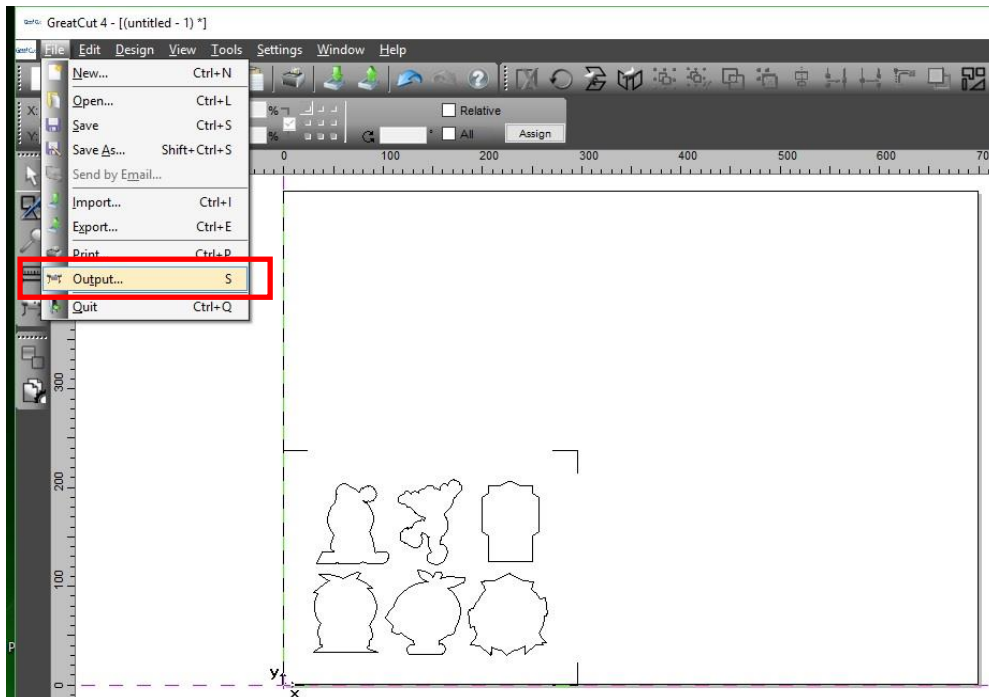
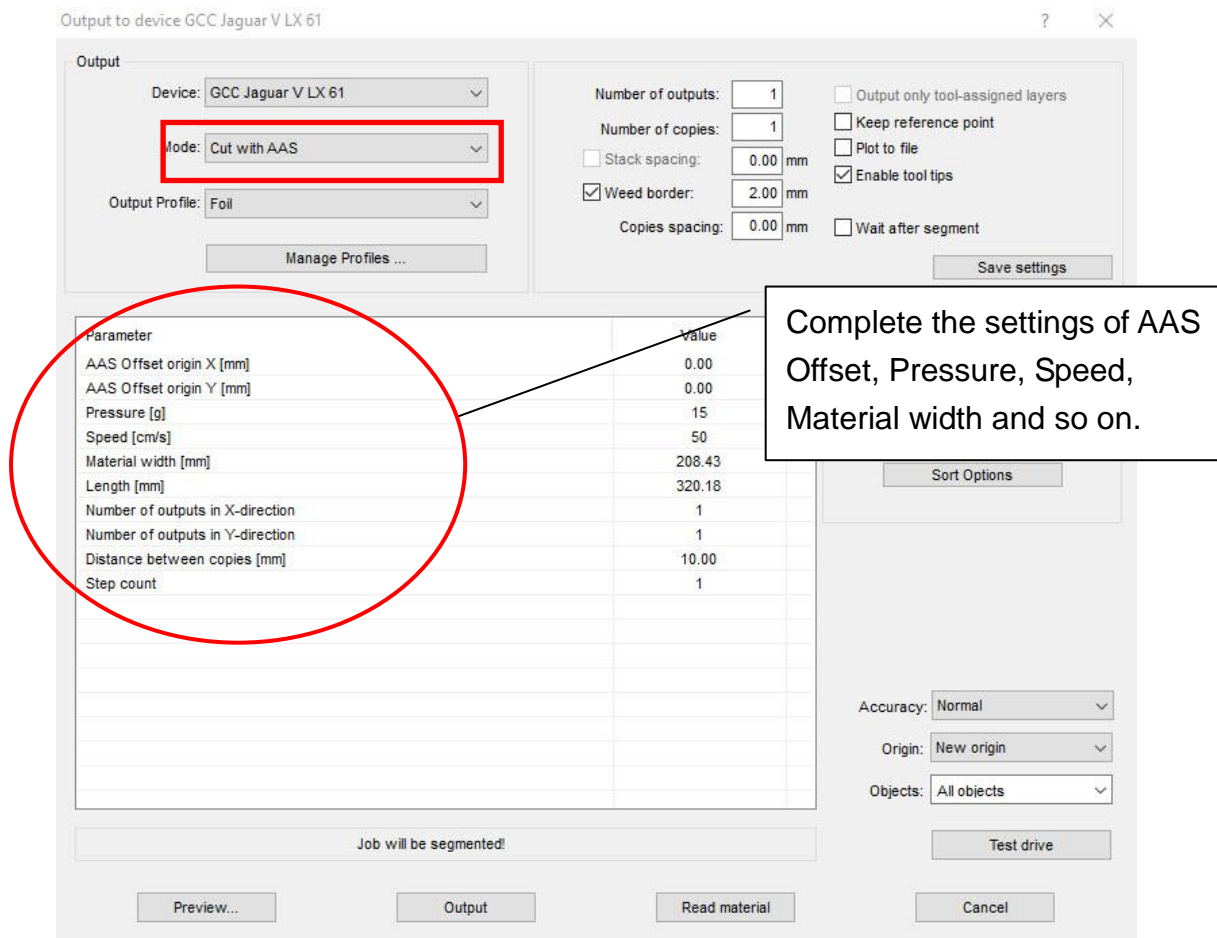
Step 3 Select Output under File.**Step 4** Select Cut with AAS in Mode/Tool in the Output to device window.

Step 5 Click output and the object will be sent to GCC Cutting Plotter.

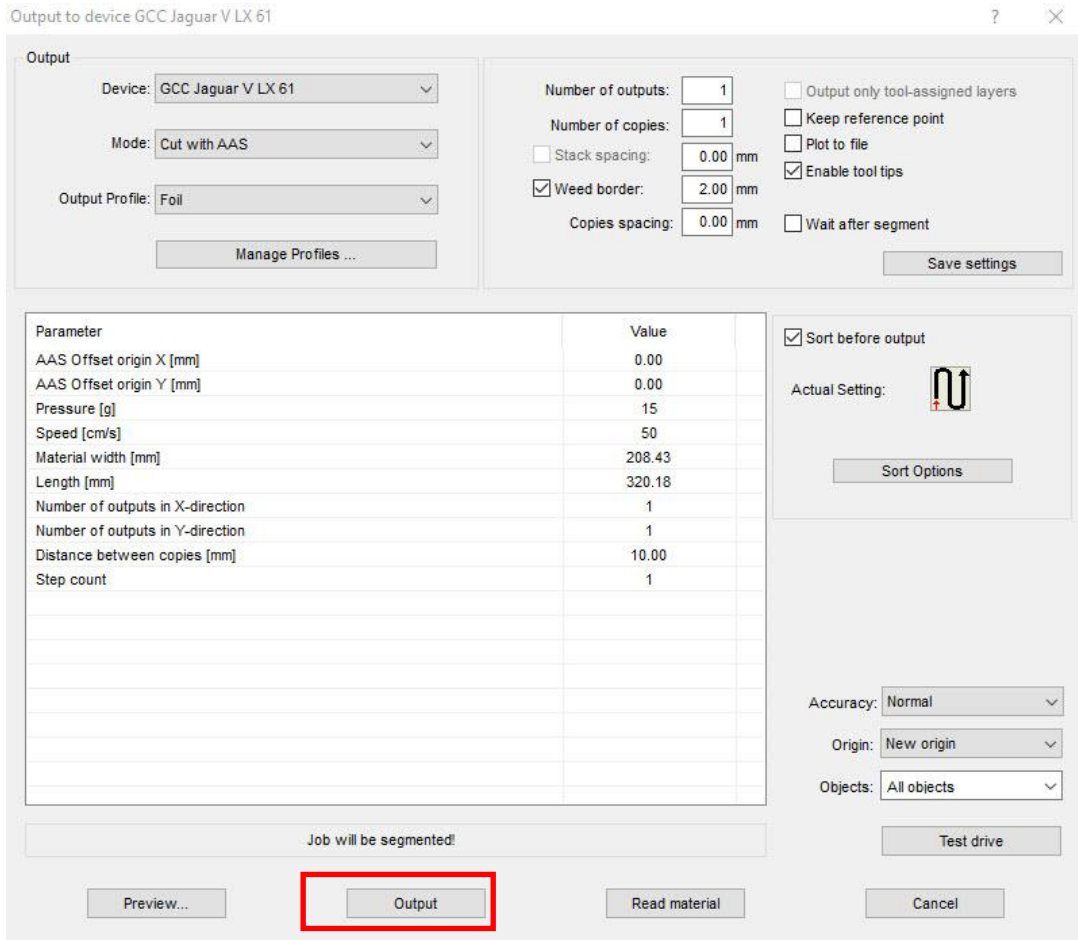

Note: The difference amount Number of outputs, Number of copies, and Step count in the Output window.

Output to device GCC Jaguar V LX 61

Output

Device: GCC Jaguar V LX 61

Mode: Cut with AAS

Output Profile: Foil

Manage Profiles ...

Number of outputs: 1

Number of copies: 1

Stack spacing: 0.00 mm

Weed border: 2.00 mm

Copies spacing: 0.00 mm

Output only tool-assigned layers

Keep reference point

Plot to file

Enable tool tips

Wait after segment

Save settings

Parameter	Value
AAS Offset origin X [mm]	0.00
AAS Offset origin Y [mm]	0.00
Pressure [g]	15
Speed [cm/s]	50
Material width [mm]	208.43
Length [mm]	320.18
Number of outputs in X-direction	1
Number of outputs in Y-direction	1
Distance between copies [mm]	10.00
Step count	1

Sort before output

Actual Setting: 

Sort Options

Accuracy: Normal

Origin: New origin

Objects: All objects

Test drive

Job will be segmented!

Preview... Output Read material Cancel



1. When **Number of outputs** is set as 2, the square and the triangle will be cut 1 time and then the square and the triangle will be cut 1 time at next position.
2. When **Number of copies** is set as 2, the square and the triangle will be cut 2 times at the same position.
3. When **Step count** is set as 2, the square will be cut 2 times at the same position and then the triangle will be cut will be cut 2 times at the same position.

Advanced Settings

Segmental Positioning

For precise cutting quality, it is suggested to apply “Segmental Positioning” by adjusting the x and y distance when you are working on an extra long or large-size image to increase cutting quality.

Follow the same steps in the **4-Point Positioning** section to complete the contour line setting and registration mark creation procedures. Adjust the size, object margin and line thickness of your registration marks and the space between registration marks by changing X, Y distance in the Setup-Jog Marks window and click OK.

Step 1 Press the Settings icon on the GreatCut toolbar.

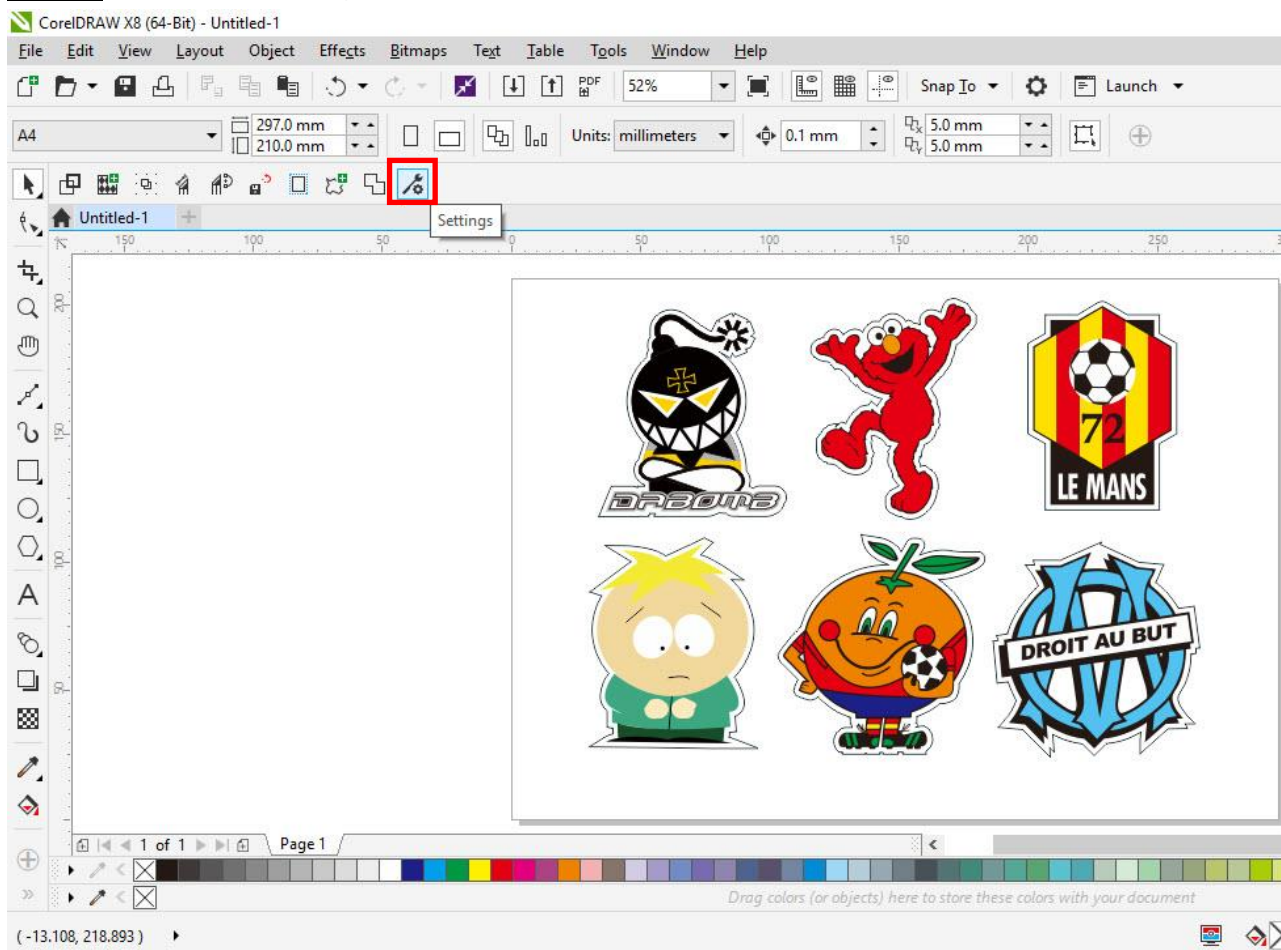

Step 2 Press the button on the right of Jog marks.

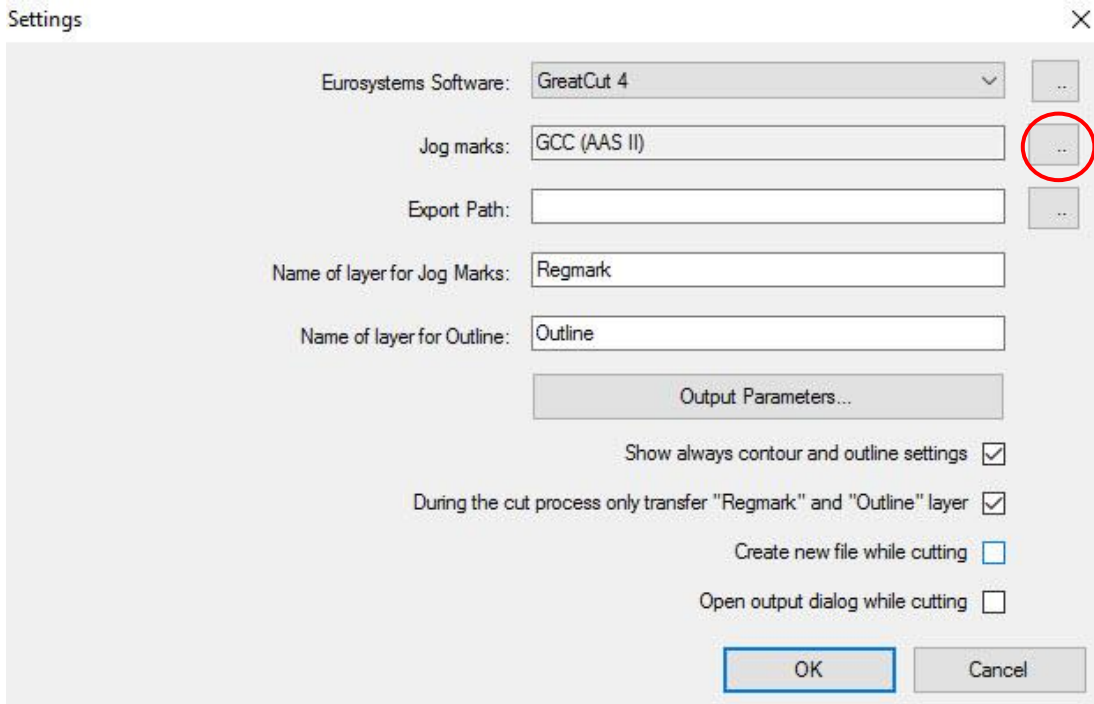

Step 3 Adjust the size, object margin and line thickness of your registration marks in the Setup-Jog Marks window and click OK.

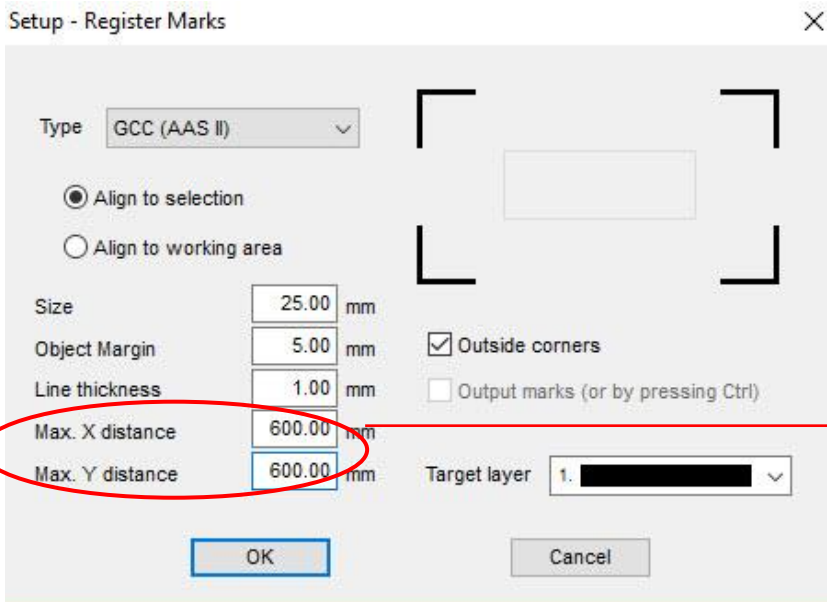

Segmental Positioning

- **Max. x Distance:** The distance of intermediate position on the X axis
→ Range: 200-500 mm
- **Max. y Distance:** The distance of intermediate position on the Y axis
→ Range: 200-500 mm

Step 4 Ensure the three items below are selected and click OK.

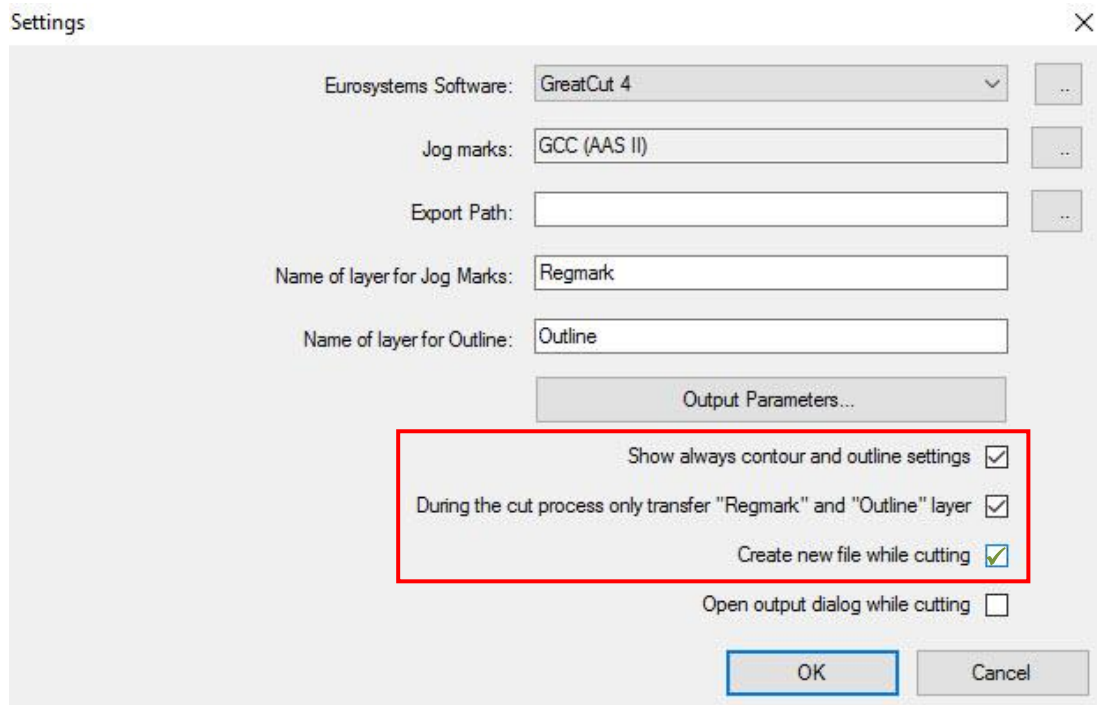

Step 5 Click the Set Jog Marks icon on the GreatCut toolbar.

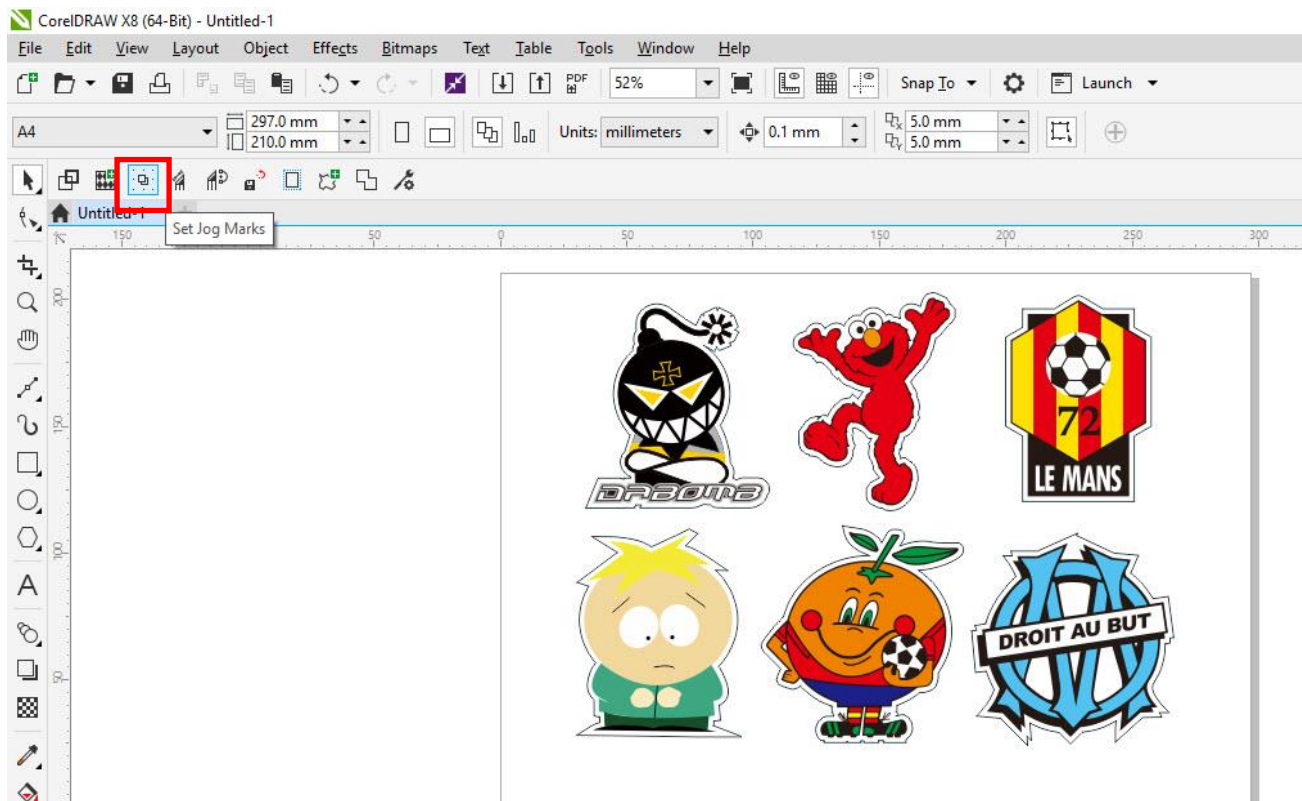

The system will create the marks as shown in the picture below.

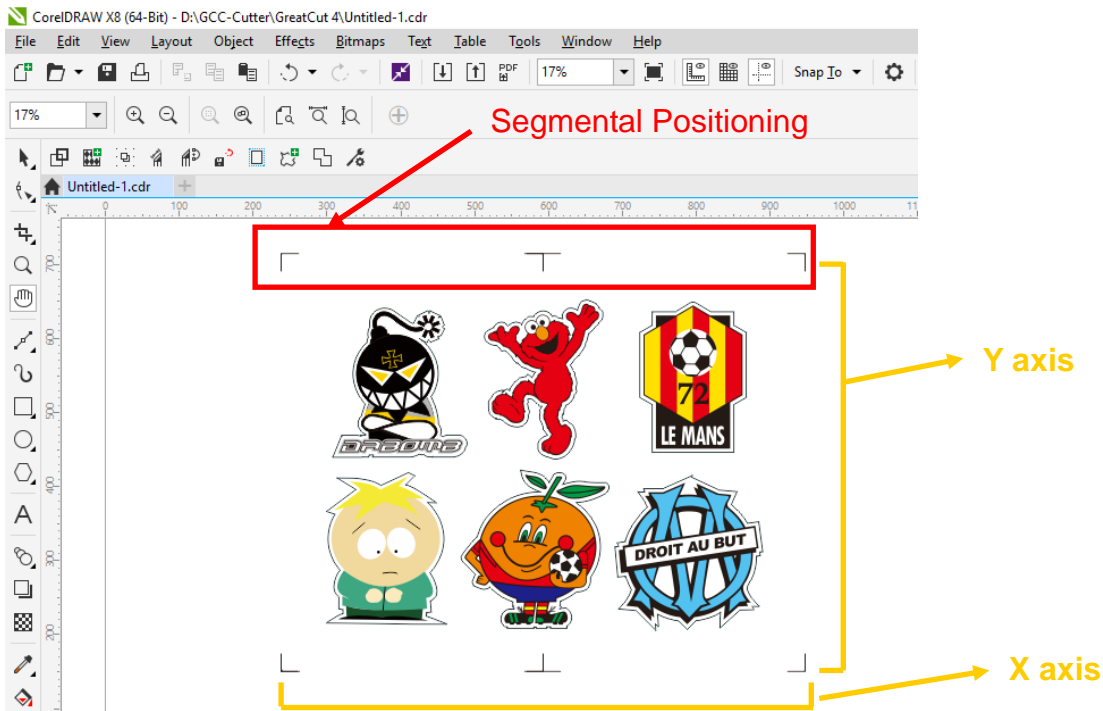

Follow the same steps in the **Output** section to output your image to GCC Cutting Plotter.

Multi-Copy

Step 1 Follow the same steps in the **4-Point Positioning** section to complete the contour line setting and registration mark creation procedures.

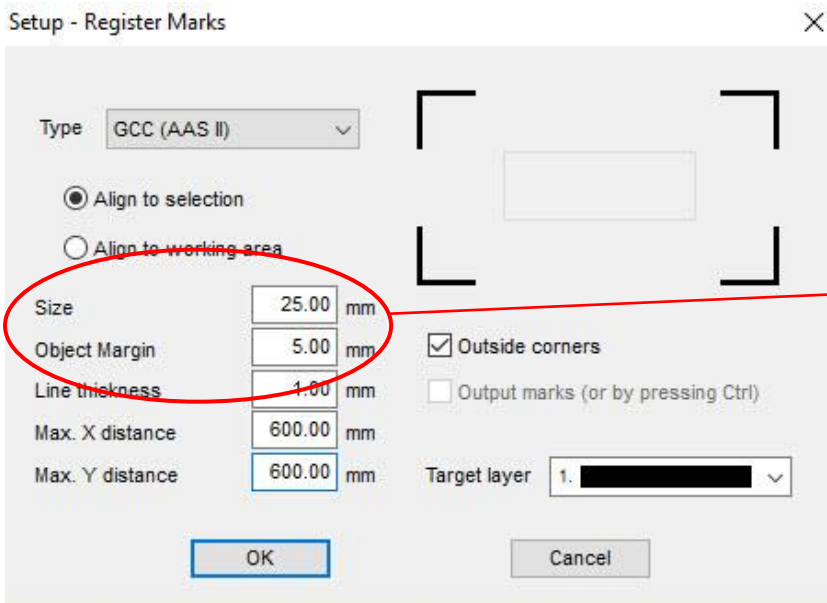

When you apply the “Multiple Copies” function, the value that has been set in this section will still be applied.

Step 2 Click on the Set Jog Marks icon on the GreatCut toolbar and 4 marks will be created as shown in the picture below.

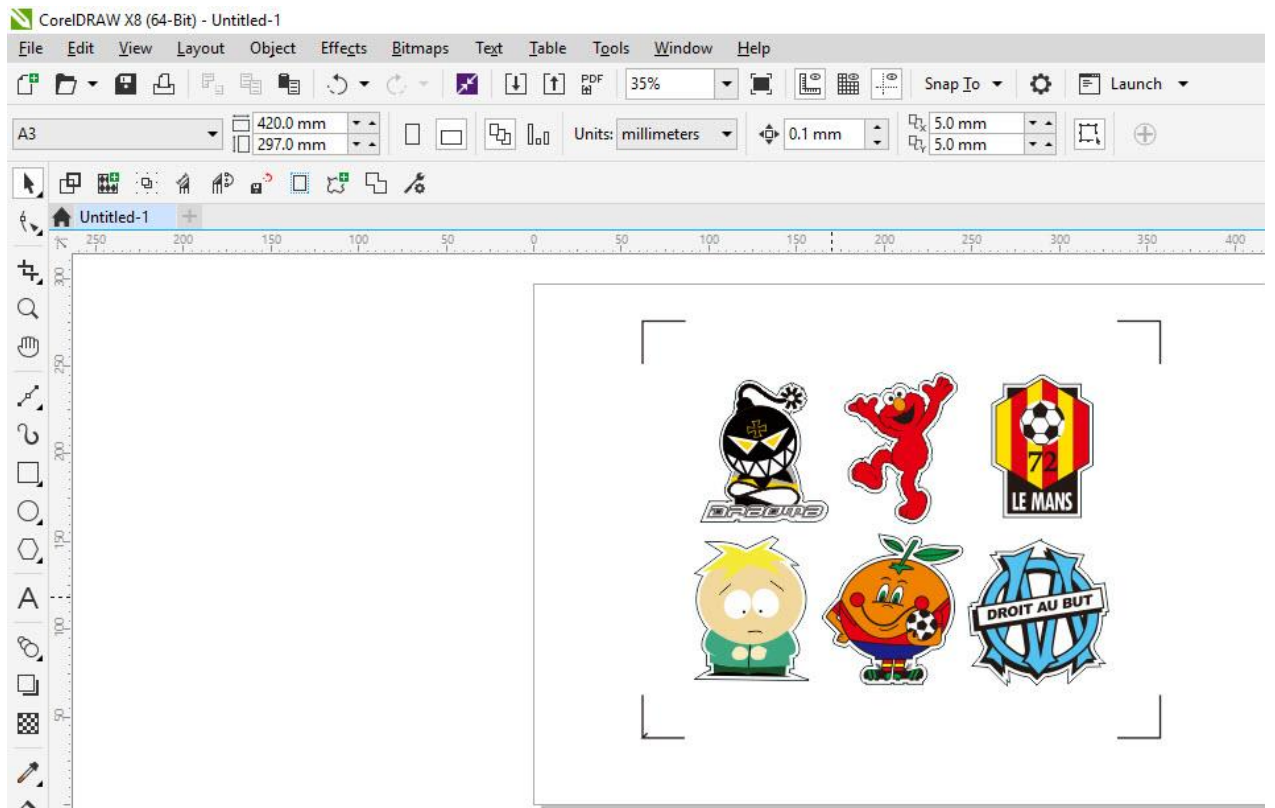
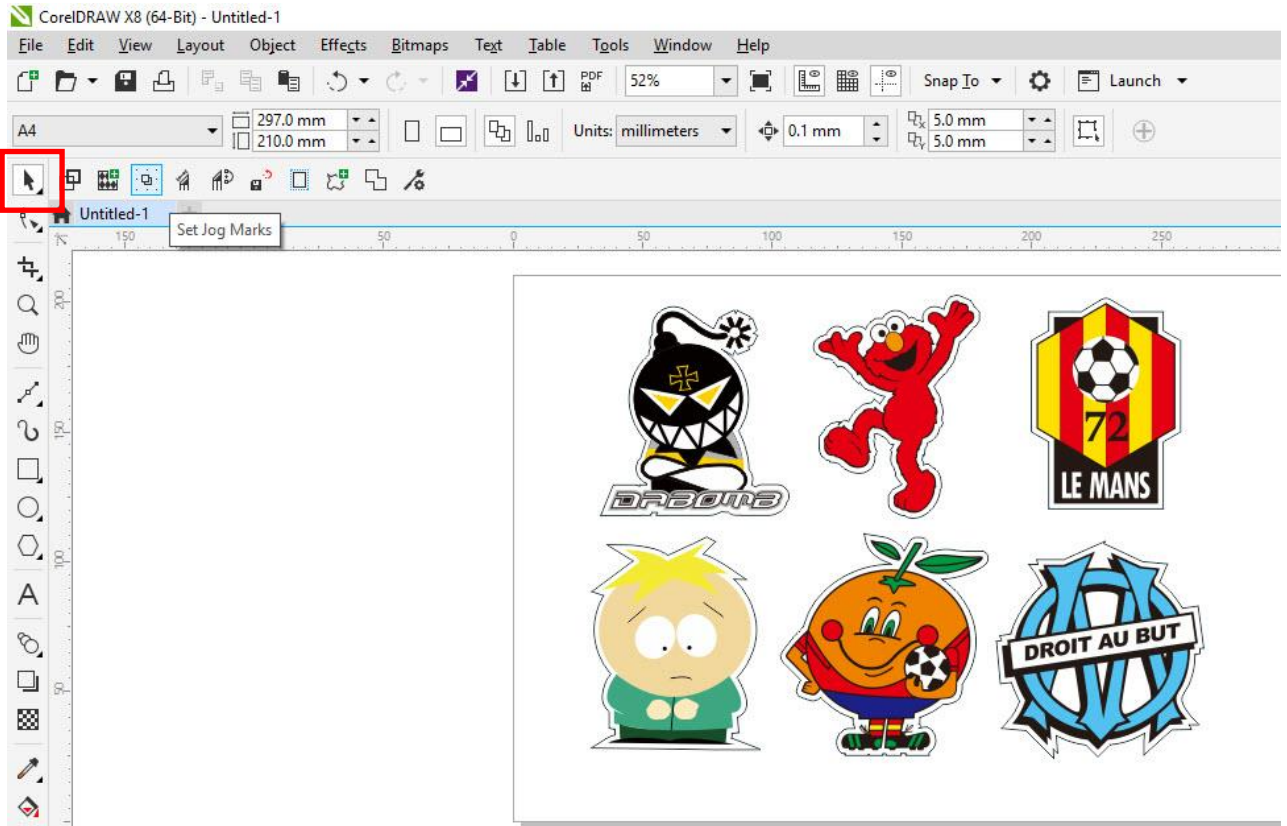

Step 3 Select both the entire object (including registration marks and the contour line) and press the Cut icon on the GreatCut toolbar.

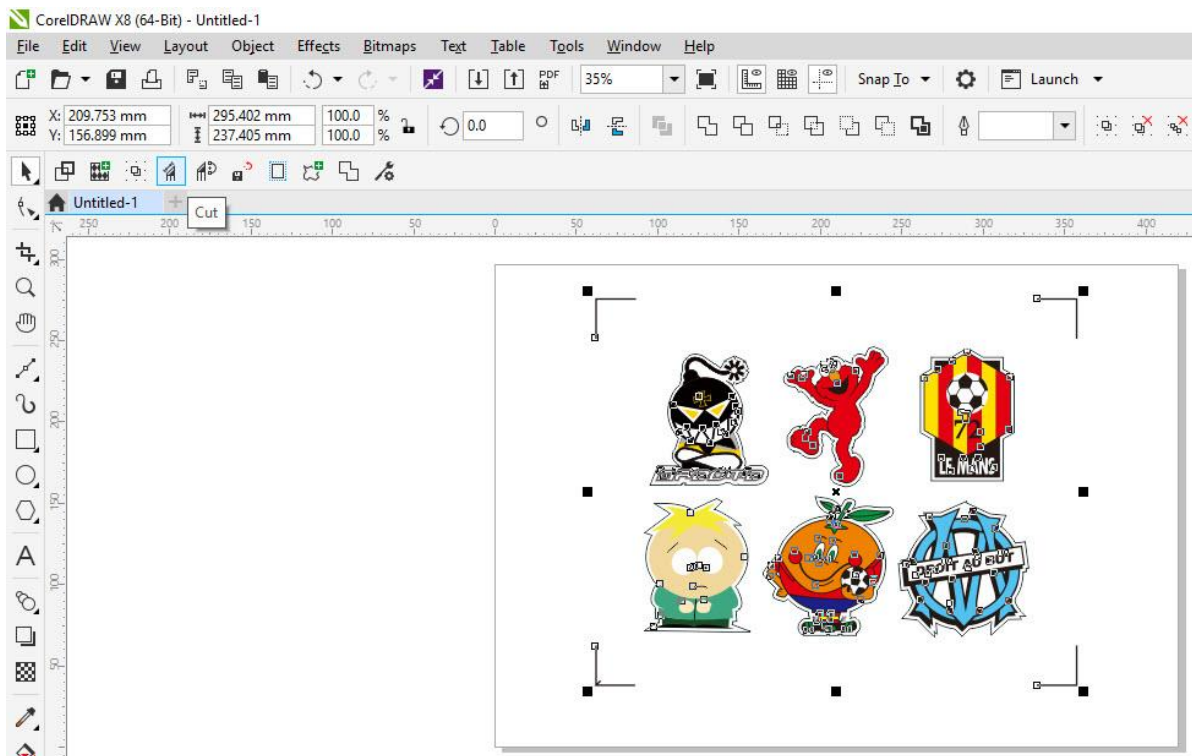

Step 4 The system will activate GreatCut automatically and import the registration marks and contour line to GreatCut.

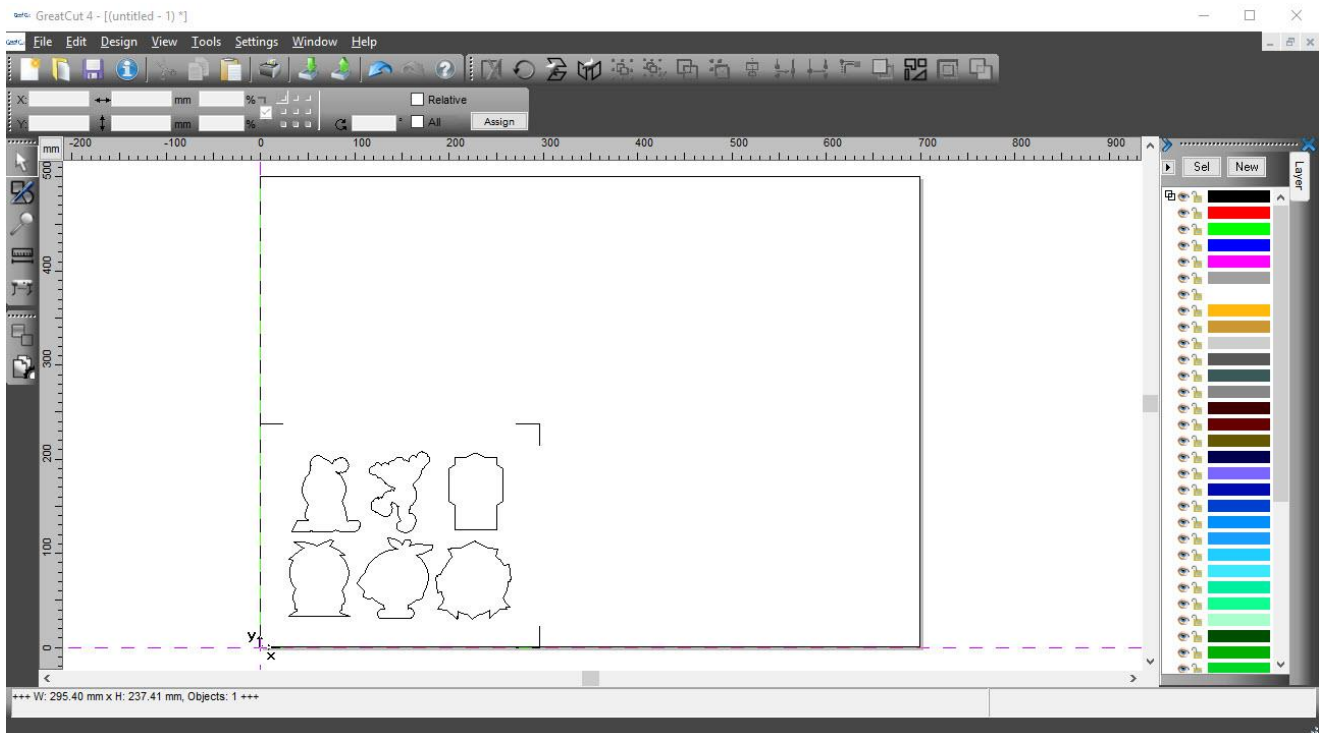

Step 5 Select Output under File.

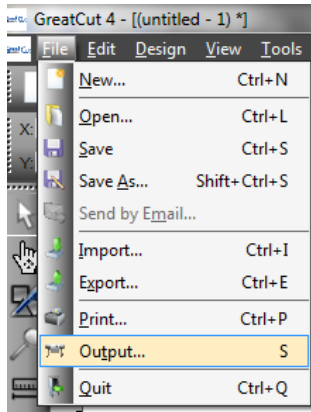

Step 6 Select Mode as “Cut with AAS” and input the Number of outputs in X-direction and Y-direction and Distance between copies, please don’t press output button.

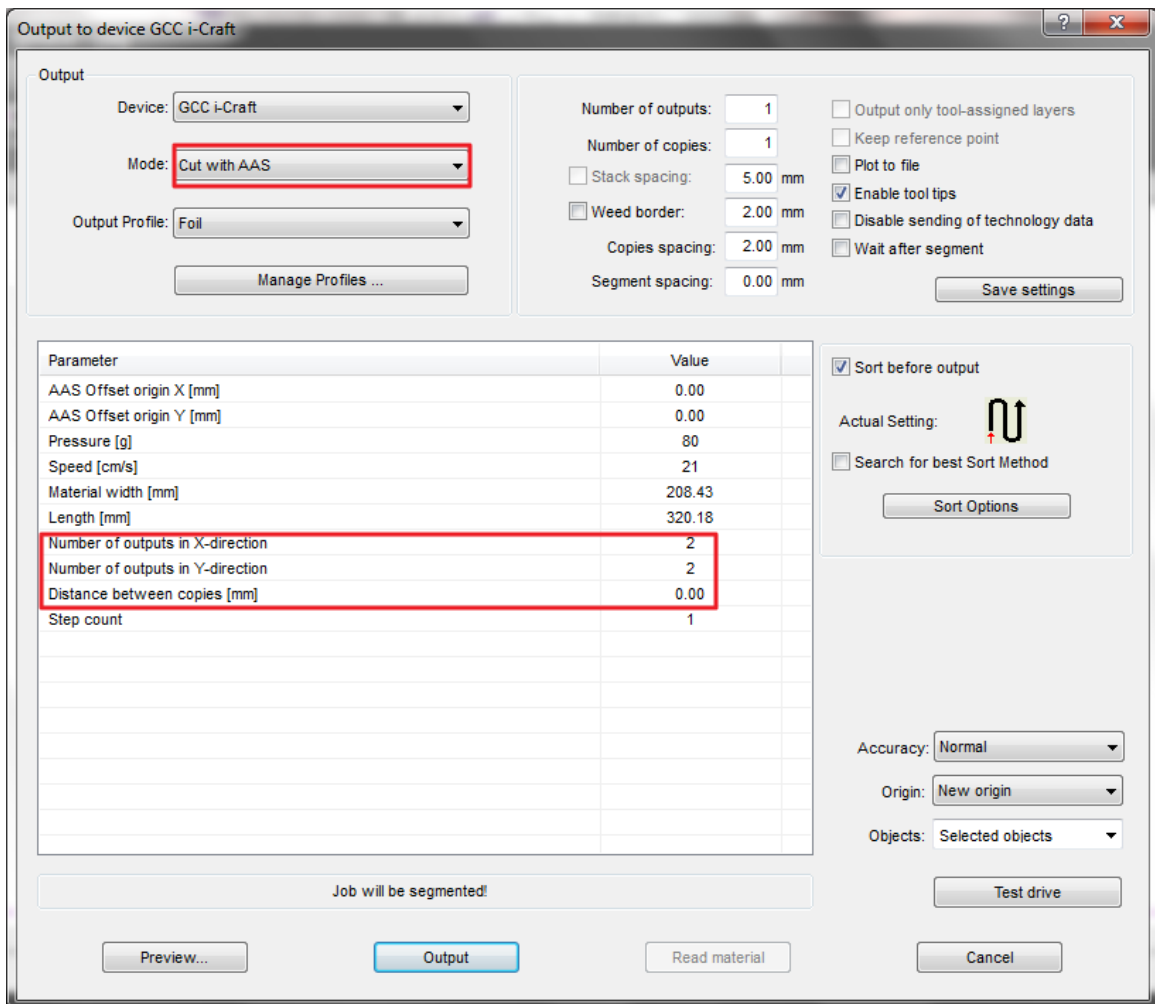

Step 7 Back to CorelDRAW, Click Multi-Copy on GreatCut under File.

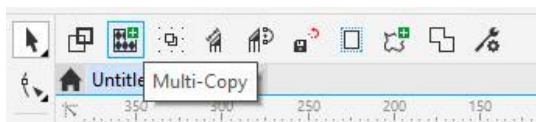

Step 8 Complete the Number in X/Y (the number of copies desired on the X/Y axis) and Distance in X/Y (distance between each copy) settings then click OK. Confirm that the value of Distance in X/Y must be the same with step 6.

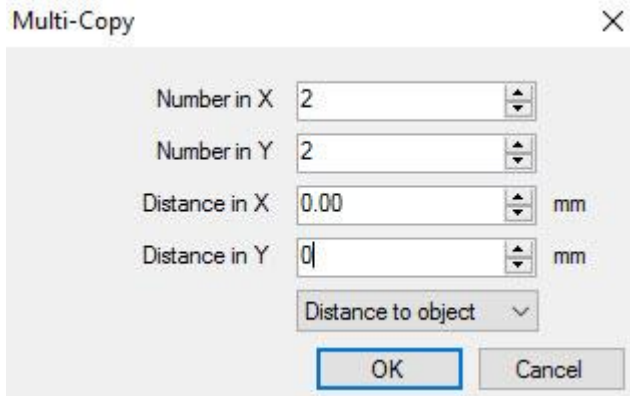

Note: The spacing of vertical & horizontal (Offset X & Y) should be $\geq 20\text{mm}$ or $= 0\text{mm}$; users are advised to set the Distance in X/Y as 0 mm to remove the space between each copy to avoid the waste of materials.

Step 9 The system will create several copies of the object with registration marks as shown in the picture below.

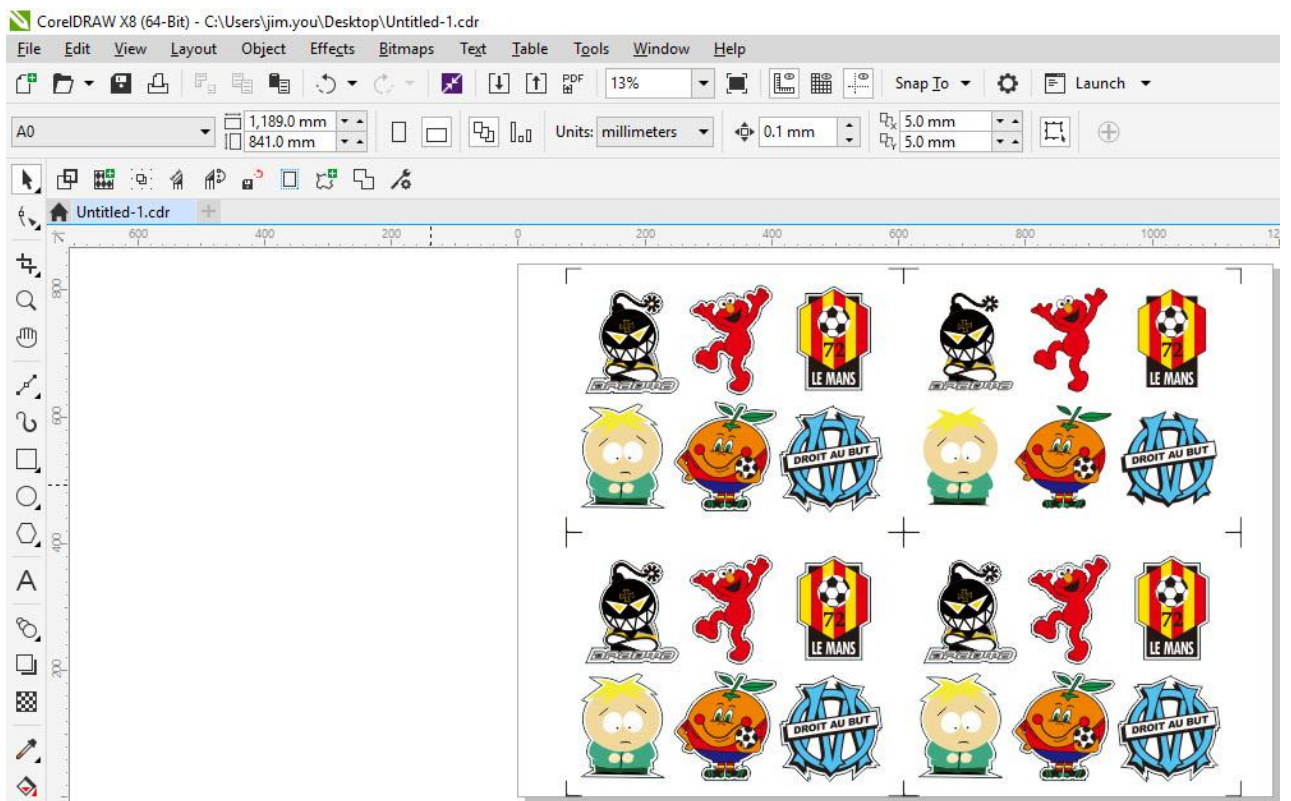

Step 10 Print the Multi-Copy images out, and put the printed media on the GCC cutting plotter.

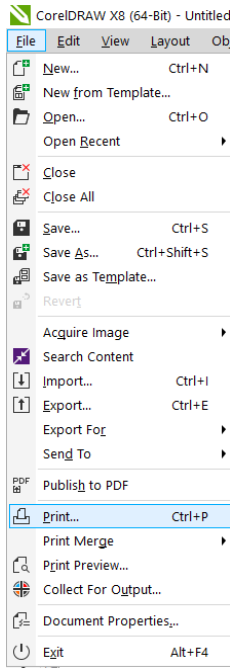

Step 11 Go to GreatCut window, press Output button.

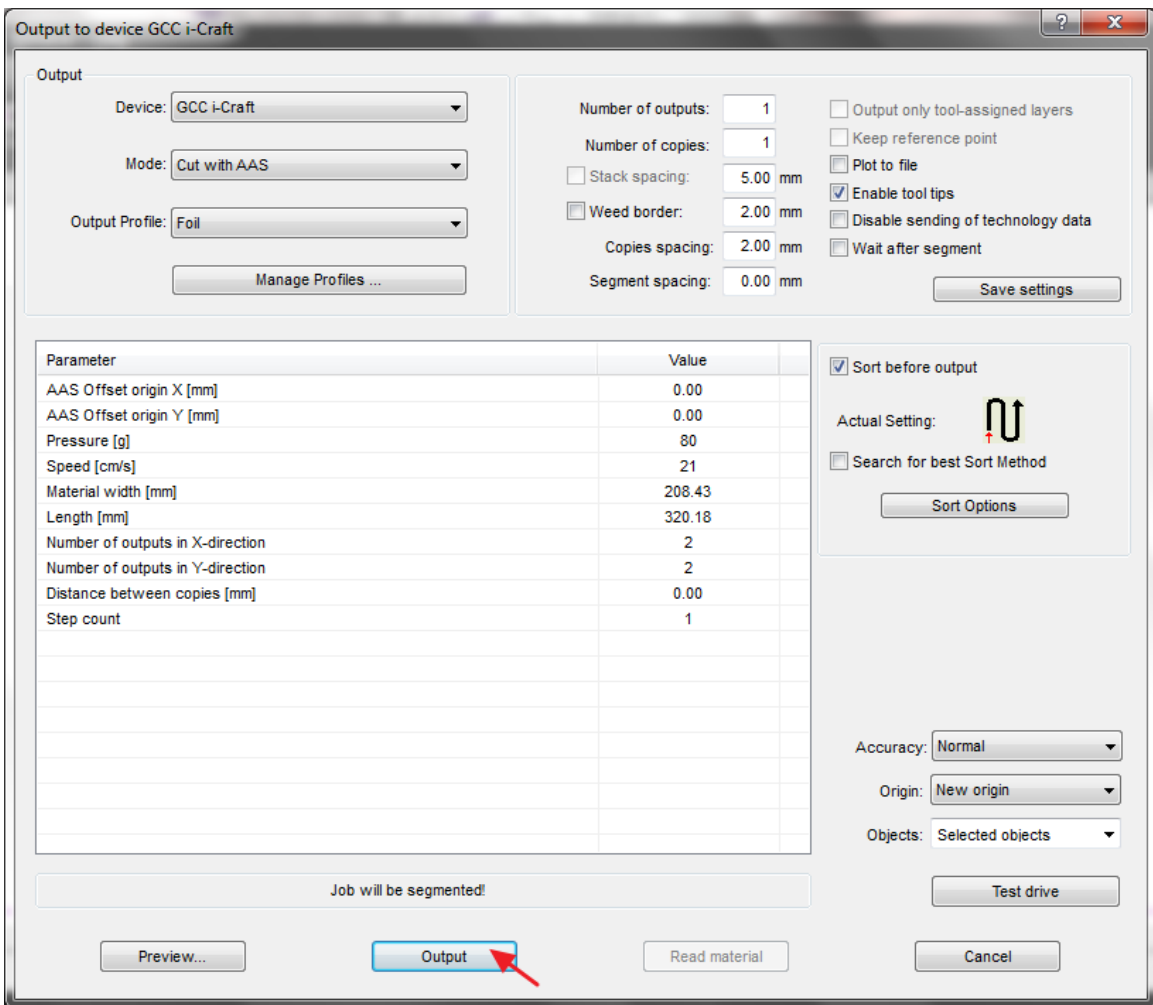

Edit your image in Adobe Illustrator

4-Point Positioning

Step 1 Create a new file in Adobe Illustrator.



Step 2 Select the image and go to Contour in GreatCu in File.

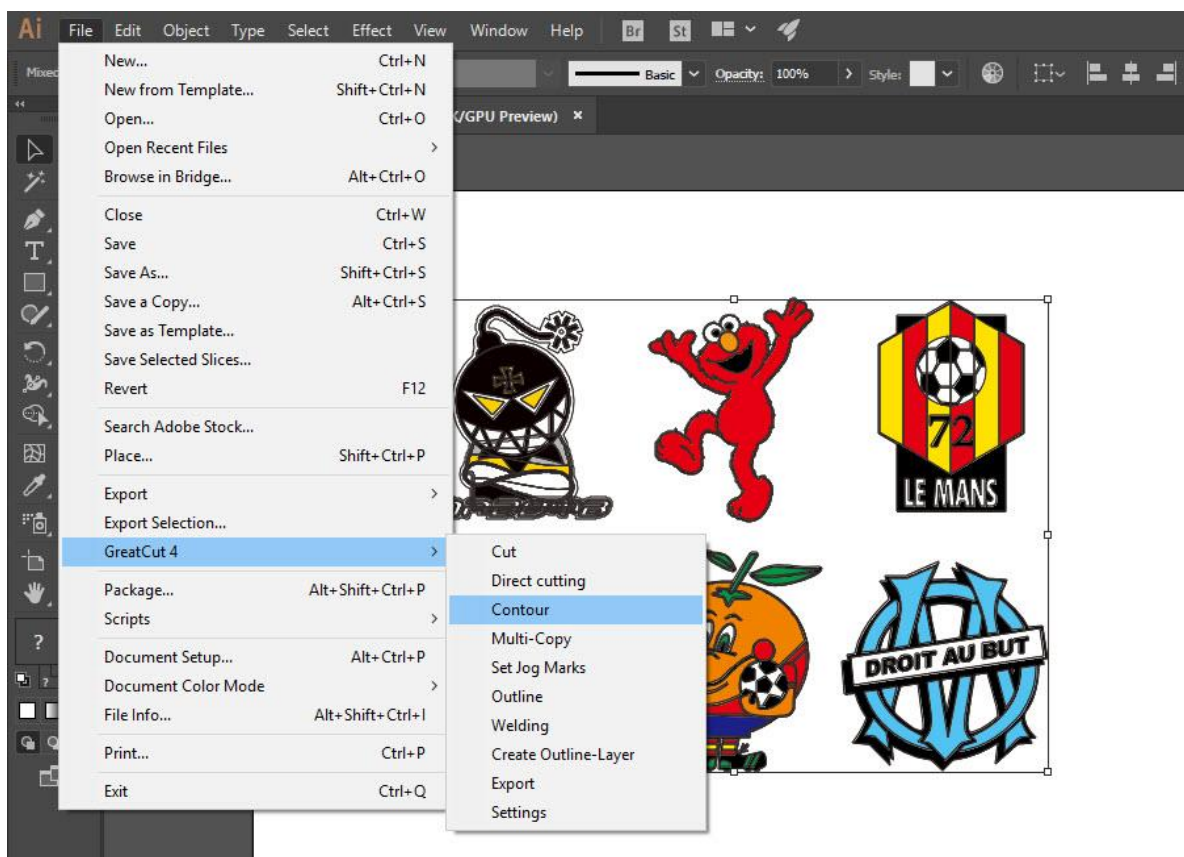

Step 3 Complete contour line settings (including contour offset value) and press Calculate to confirm.

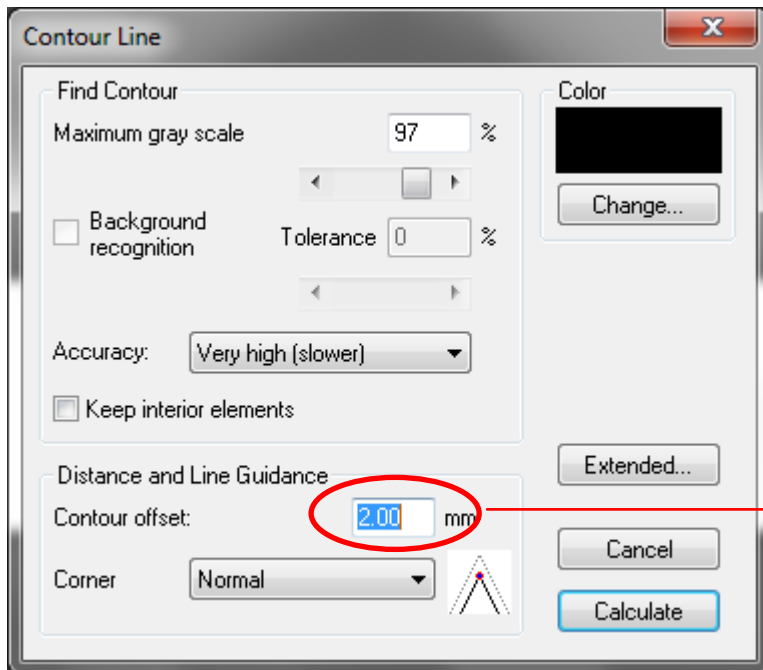

Contour offset is the distance between the object and the contour line.

Contour line is now added to the object.



Tips: Vector object to create round outline

In general for vector objects you will get better results with the outline function. You will see the difference between "Normal" and "Round" in sharp corners. The picture is shown as below:

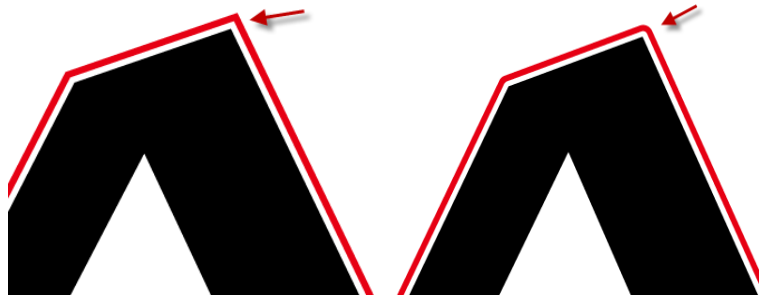

Normal

Round

1. Select the "Outline" in GreatCut option under File to create contours in a freely definable distance around text objects.

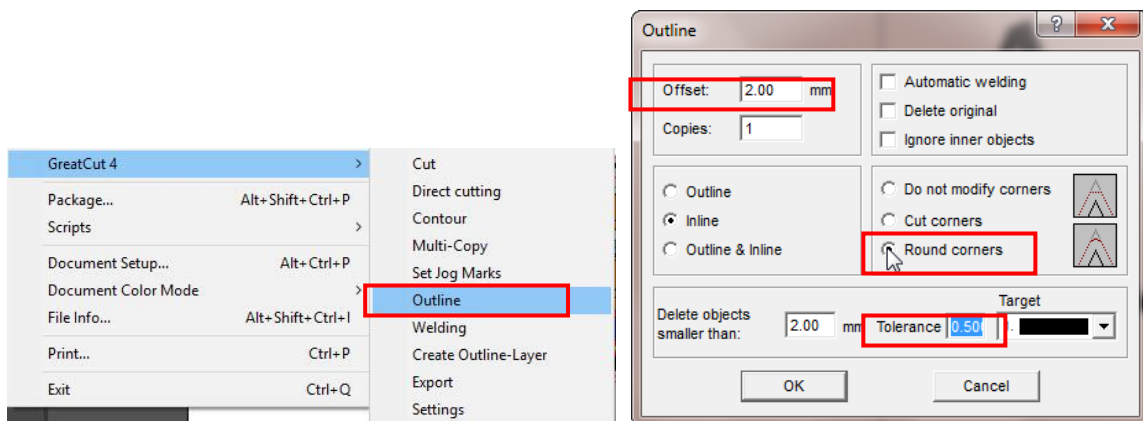

2. Select "Round corners" and set the value of "offset" and "tolerance."

Offset is the value for the distance of the inline and outline from the original object. The field **tolerance** indicates in which offset from the corner dot is cut respectively rounded.

Step 4 Click Settings on GreatCut under File.

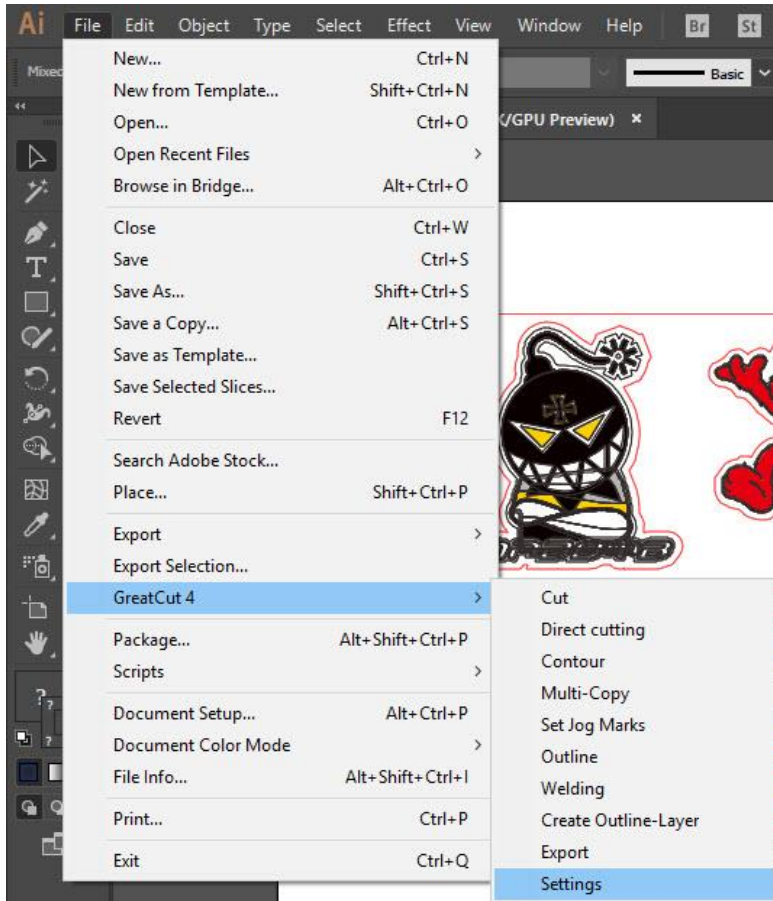

Step 5 Press the button on the right of Jog marks.

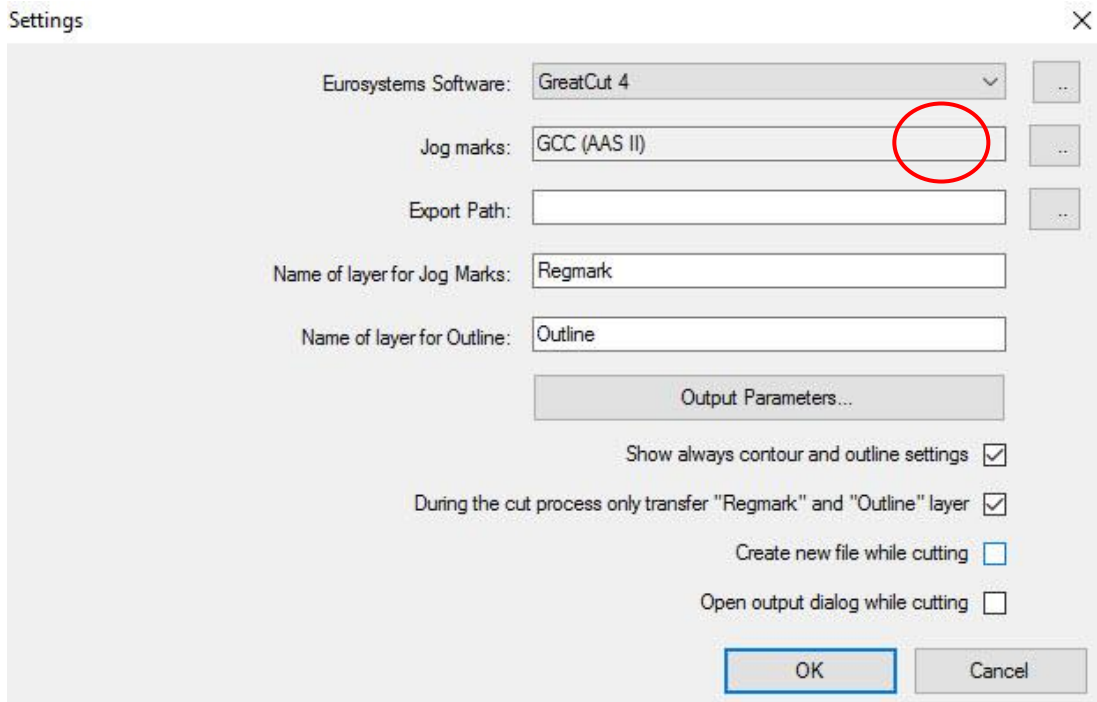

Step 6 Adjust the size, object margin and line thickness of your registration marks and click OK.

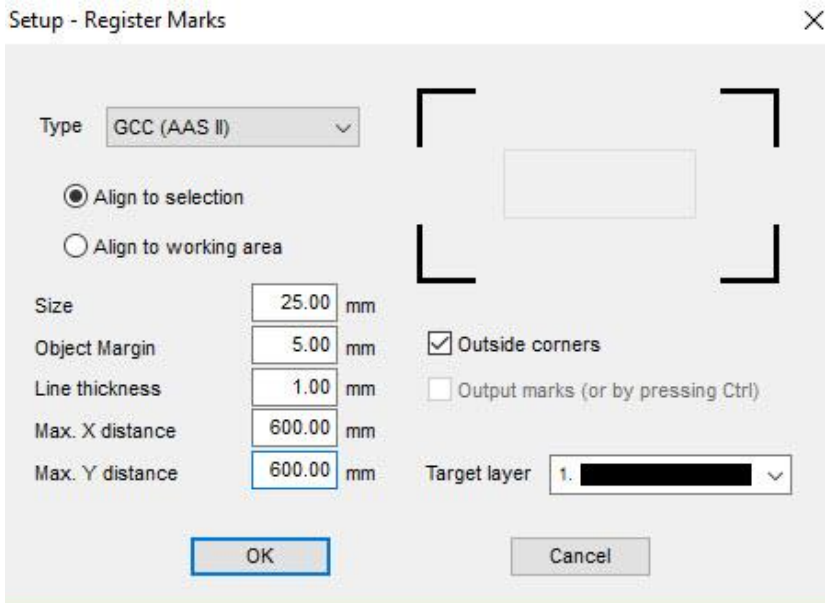

4-Point Positioning

- **Size:** The length of marks
→ Range: 5mm~50mm
→ Optimized Setting: 25mm
- **Object margin:** The distance between marks and images
→ Range: 0mm~50mm
→ Optimized Setting: 5mm
- **Line thickness:** the line thickness of marks
→ Range: 1mm~2mm
→ Optimized Setting: 1mm

Step 7 Ensure the three items below are selected and click OK.

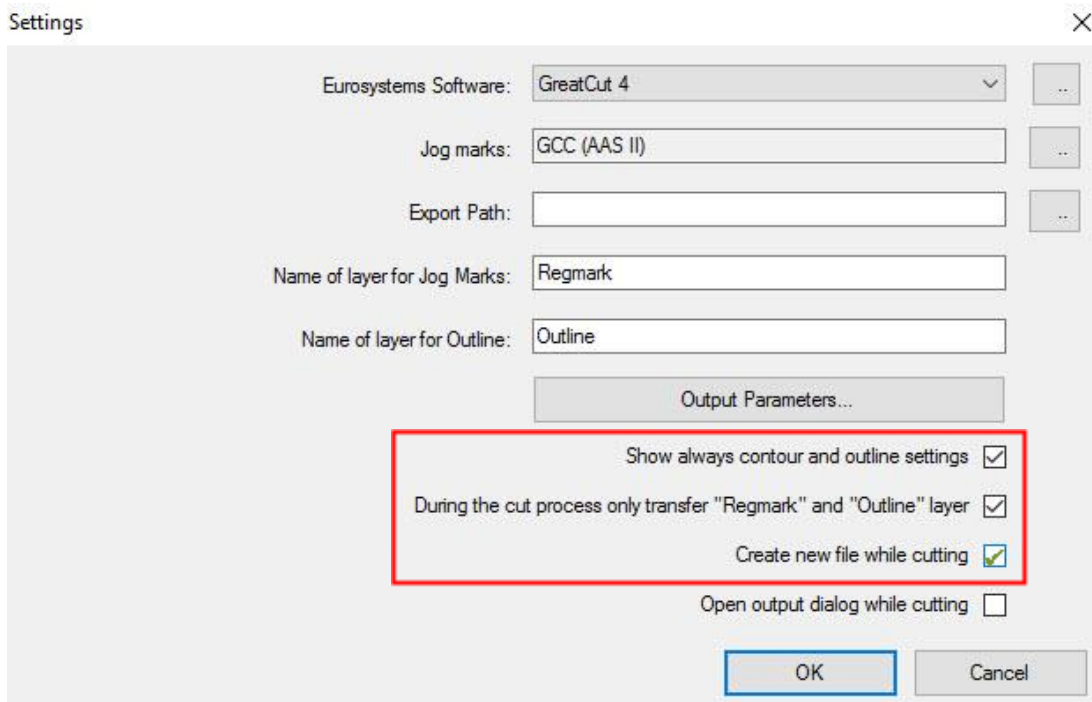

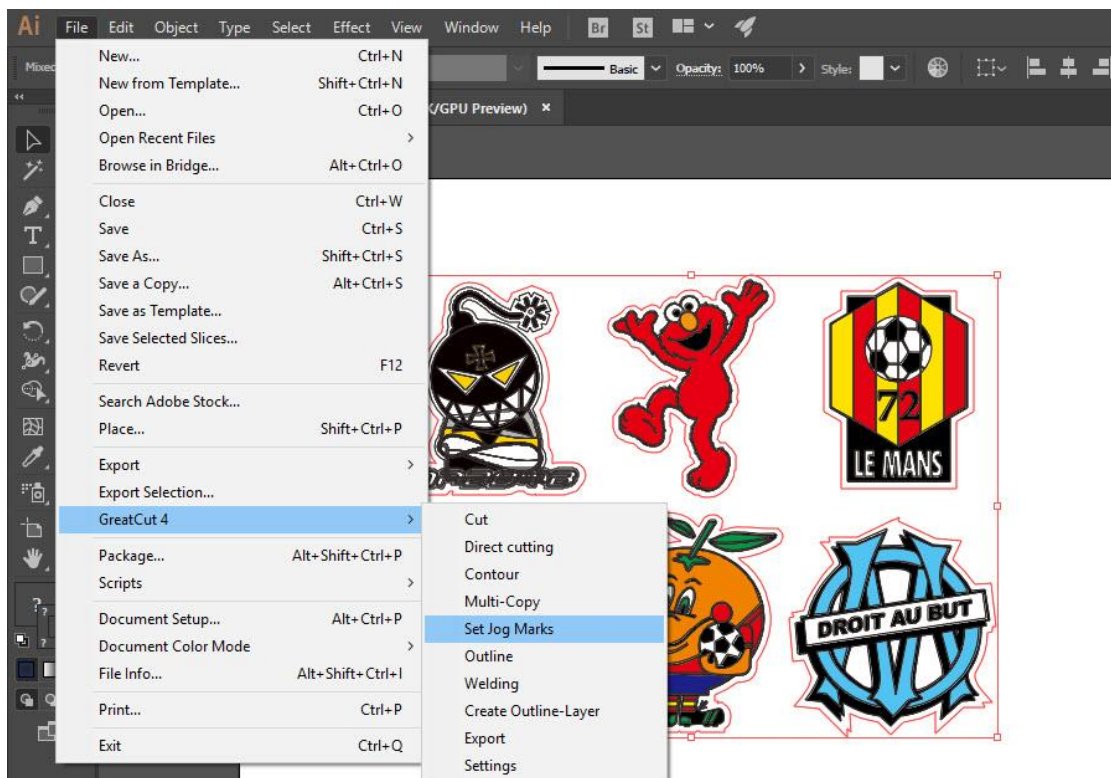
Step 8 Click Set Jog Marks on GreatCut under File.

The system will create the 4 marks as shown in the picture below.

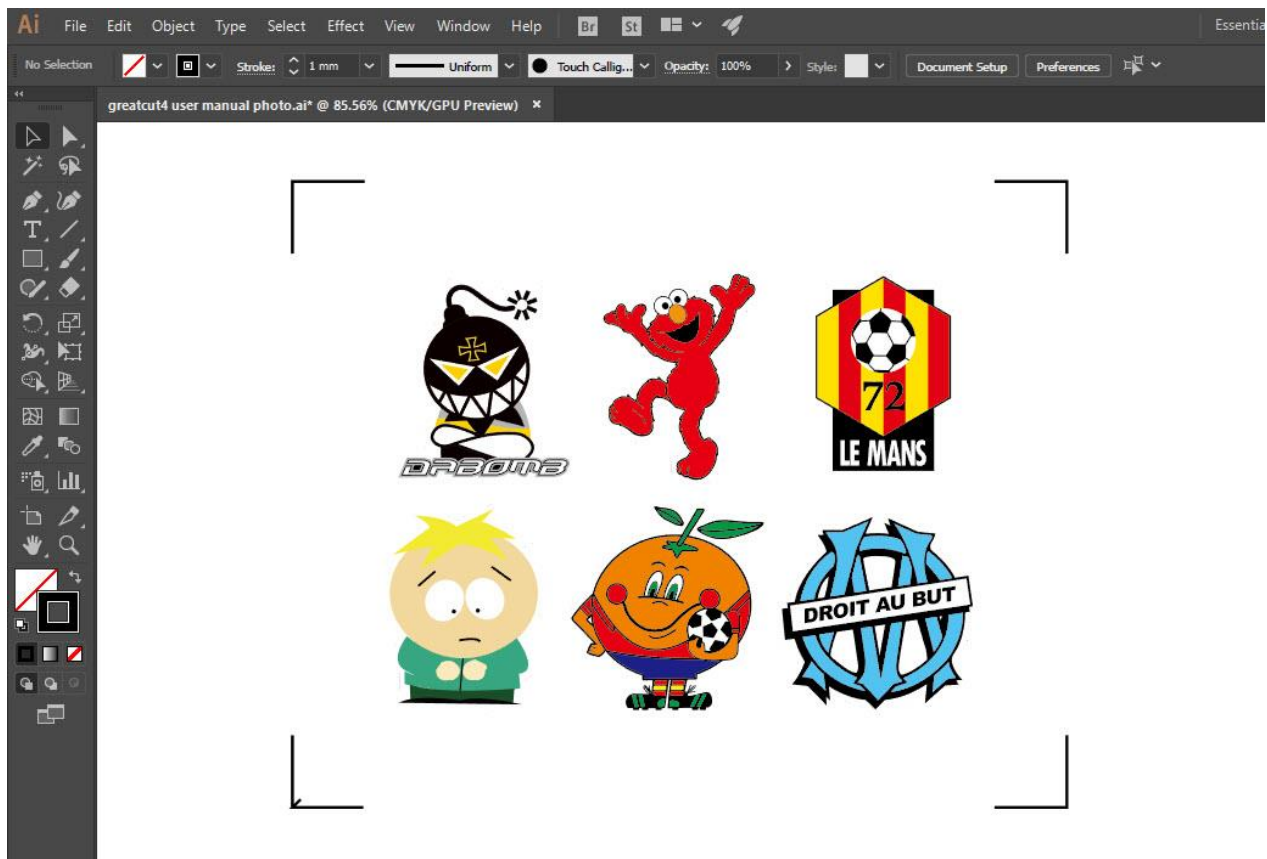

Output

Step 1 Select both the entire object (including registration marks and the contour line) then click Cut on GreatCut under File.

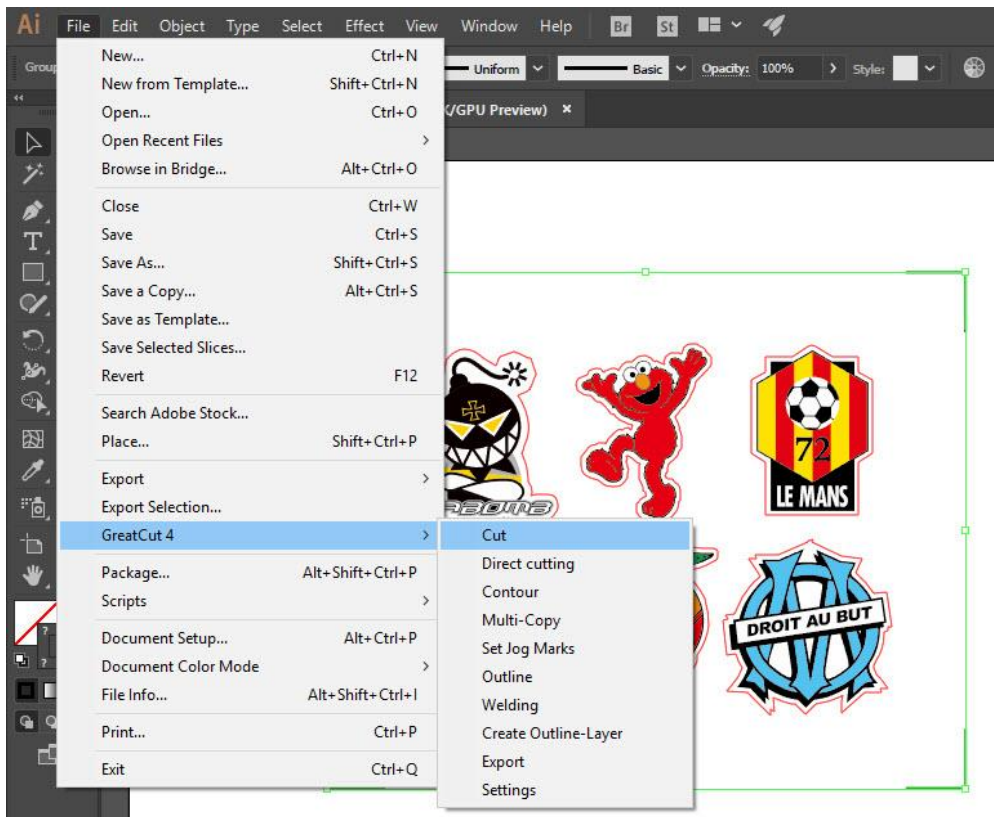

Step 2 The system will activate GreatCut automatically and import the registration marks and contour line to GreatCut.

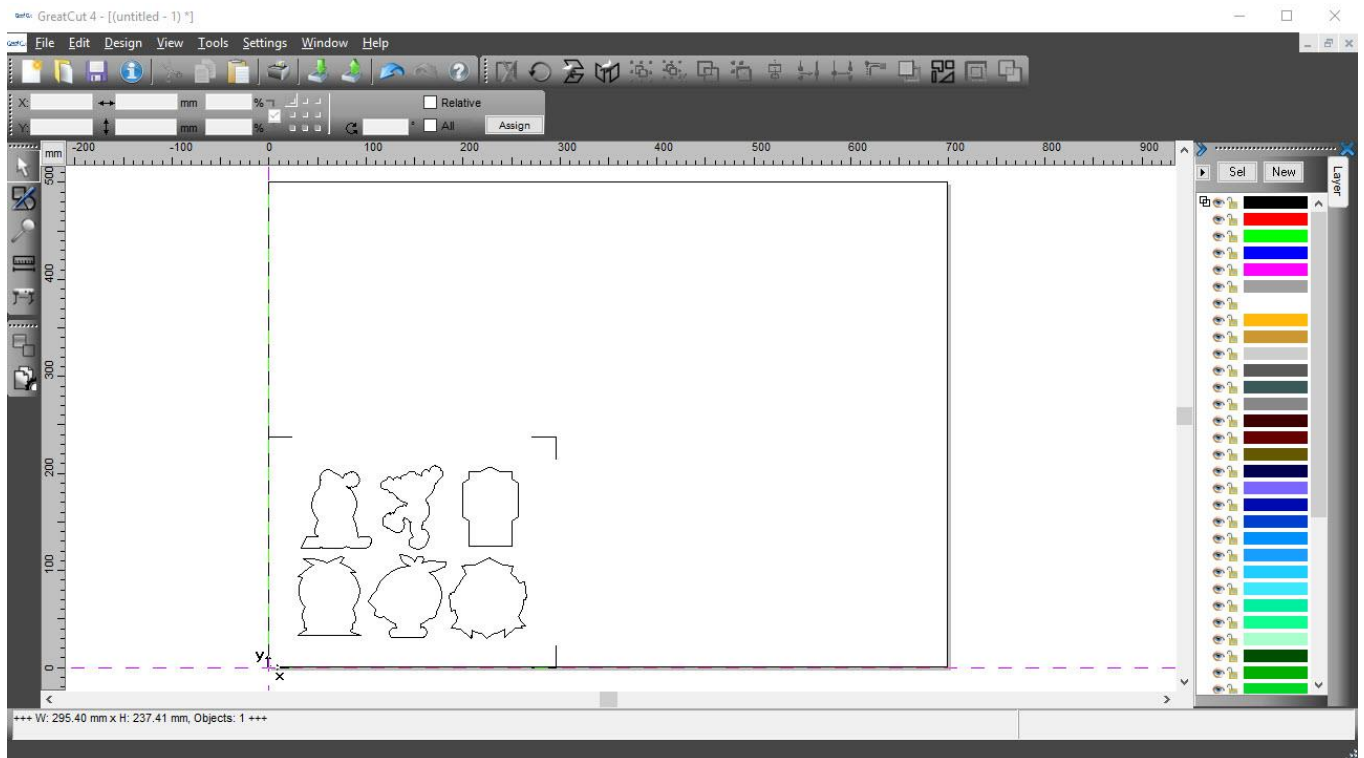

Step 3 Select Output under File.

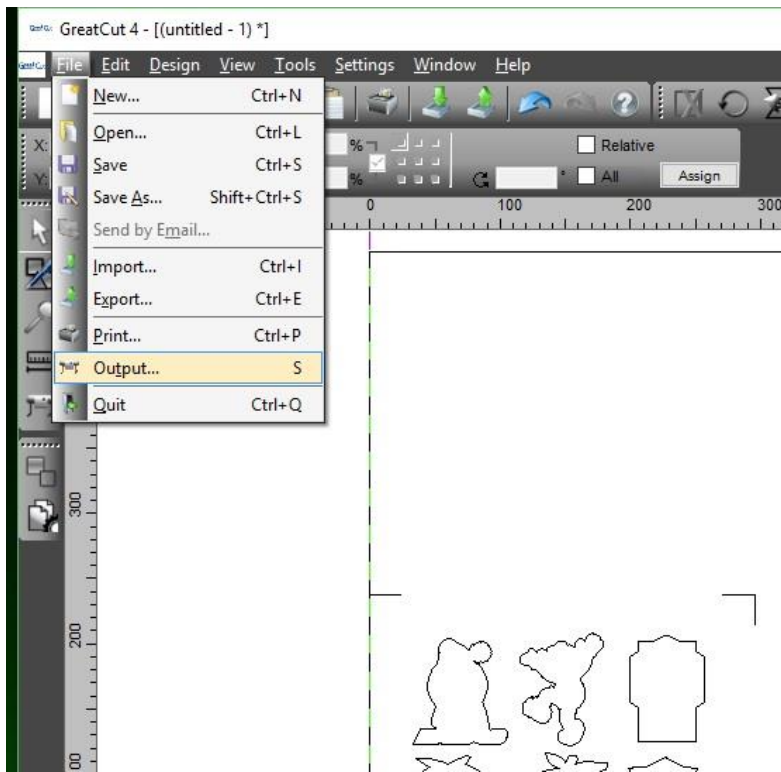

Step 4 Select Cut with AAS in Mode/Tool in the Output to device window.

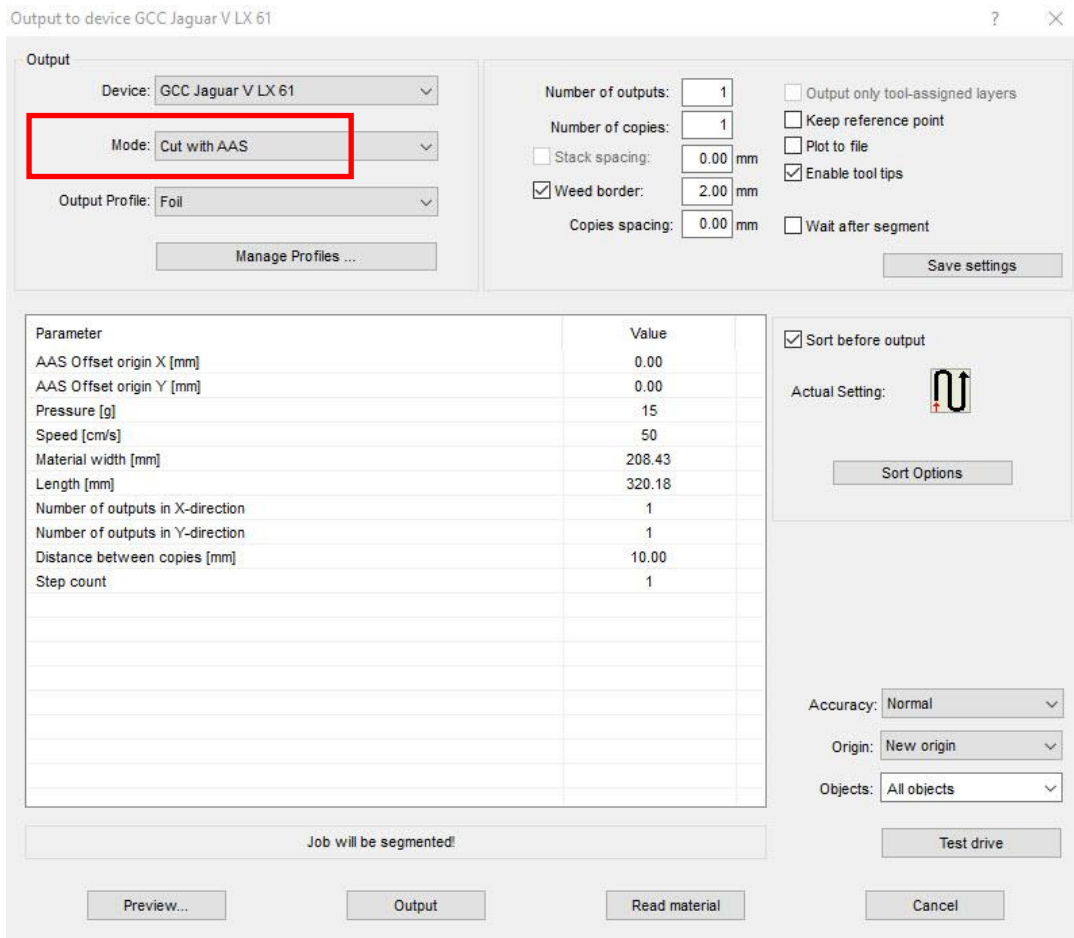

Step 5 Click output and the object will be sent to GCC Cutting Plotter

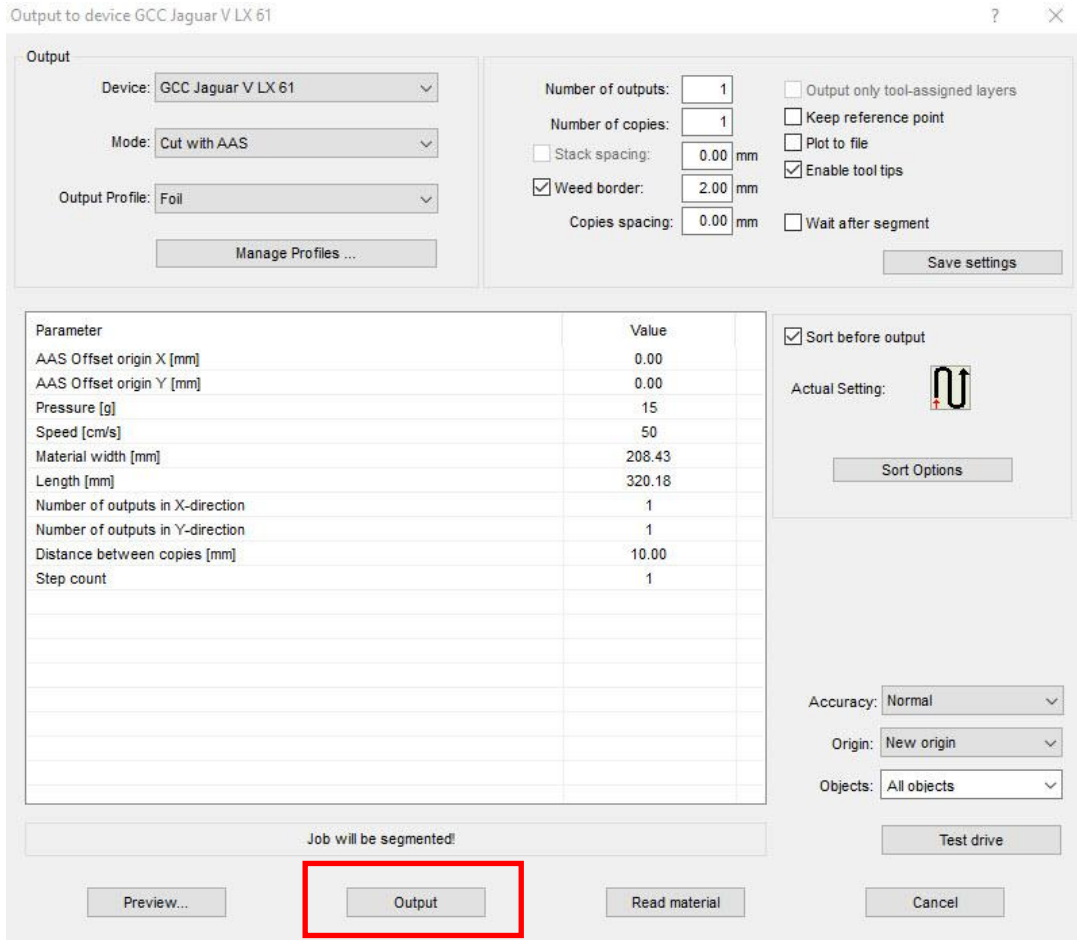

Note: The difference amount Number of outputs, Number of copies, and Step count in the Output window.

Output to device GCC Jaguar V LX 61

Output

Device: GCC Jaguar V LX 61

Mode: Cut with AAS

Output Profile: Foil

Manage Profiles ...

Number of outputs: 1

Number of copies: 1

Stack spacing: 0.00 mm

Weed border: 2.00 mm

Copies spacing: 0.00 mm

Output only tool-assigned layers

Keep reference point

Plot to file

Enable tool tips

Wait after segment

Save settings

Parameter	Value
AAS Offset origin X [mm]	0.00
AAS Offset origin Y [mm]	0.00
Pressure [g]	15
Speed [cm/s]	50
Material width [mm]	208.43
Length [mm]	320.18
Number of outputs in X-direction	1
Number of outputs in Y-direction	1
Distance between copies [mm]	10.00
Step count	1

Sort before output

Actual Setting: 

Sort Options

Accuracy: Normal

Origin: New origin

Objects: All objects

Test drive

Job will be segmented!

Preview... Output Read material Cancel



1. When **Number of outputs** is set as 2, the square and the triangle will be cut 1 time and then the square and the triangle will be cut 1 time at next position.
2. When **Number of copies** is set as 2, the square and the triangle will be cut 2 times at the same position.
3. When **Step count** is set as 2, the square will be cut 2 times at the same position and then the triangle will be cut will be cut 2 times at the same position.

Advanced Settings

Segmental Positioning

For precise cutting quality, it is suggested to apply “Segmental Positioning” by adjusting the x and y distance when you are working on an extra long or large-size image to increase cutting quality.

Follow the same steps in the **4-Point Positioning** section to complete the contour line setting and registration mark creation procedures. Adjust the size, object margin and line thickness of your registration marks and the space between registration marks by changing X, Y distance in the Setup-Jog Marks window and click OK.

Step 1 Click Settings on GreatCut under File.

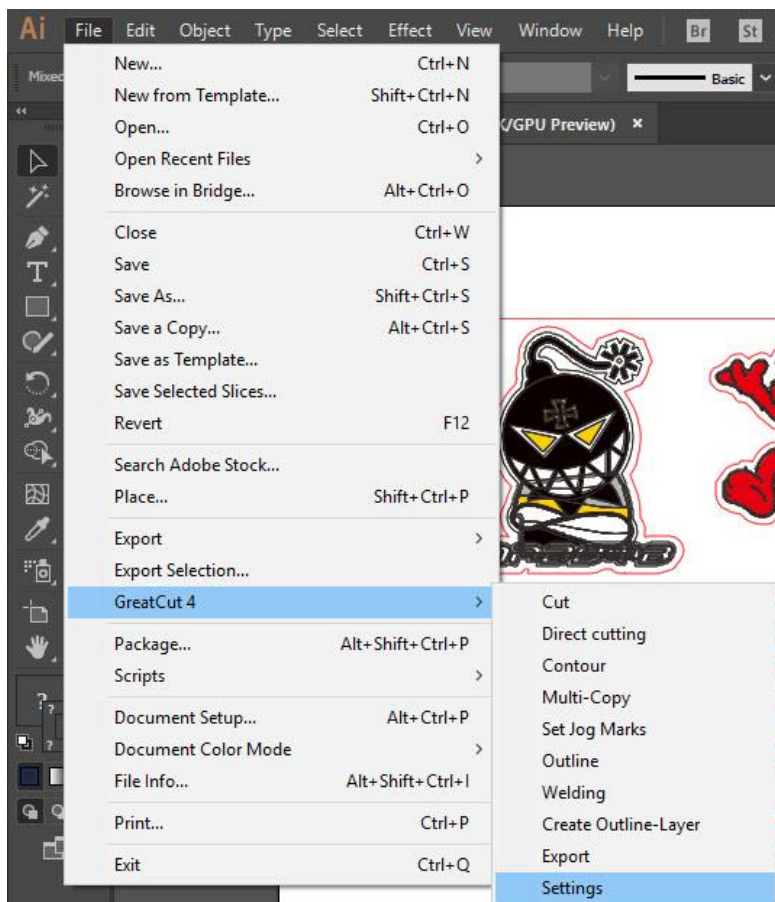

Step 2 Press the button on the right of Jog marks.

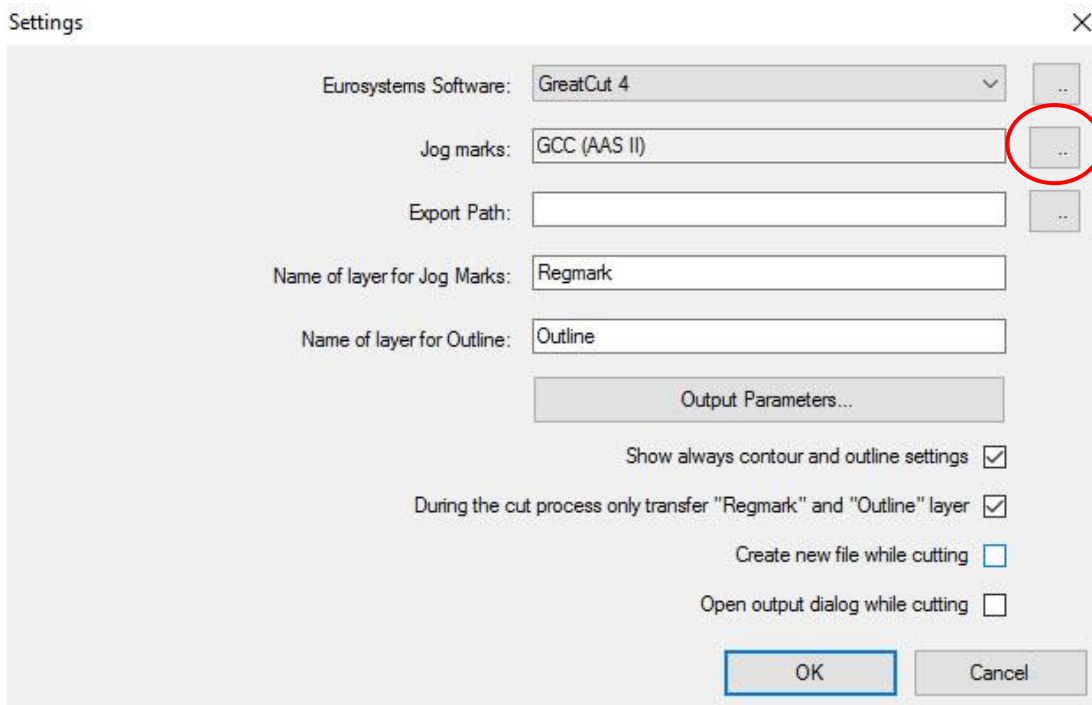

Step 3 Adjust the size, object margin and line thickness of your registration marks and click OK.

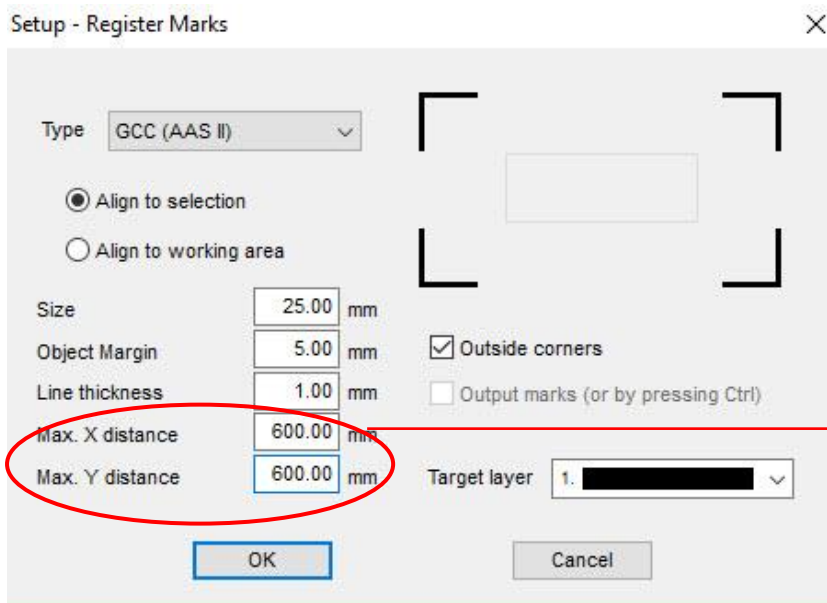

Segmental Positioning

- **Max. x Distance:** The distance of intermediate position on the X axis
→ Range: 200-500 mm
- **Max. y Distance:** The distance of intermediate position on the Y axis
→ Range: 200-500 mm

Step 4 Select the Set Jog Marks on GreatCut under File and 4 marks will be created as shown in the picture below.

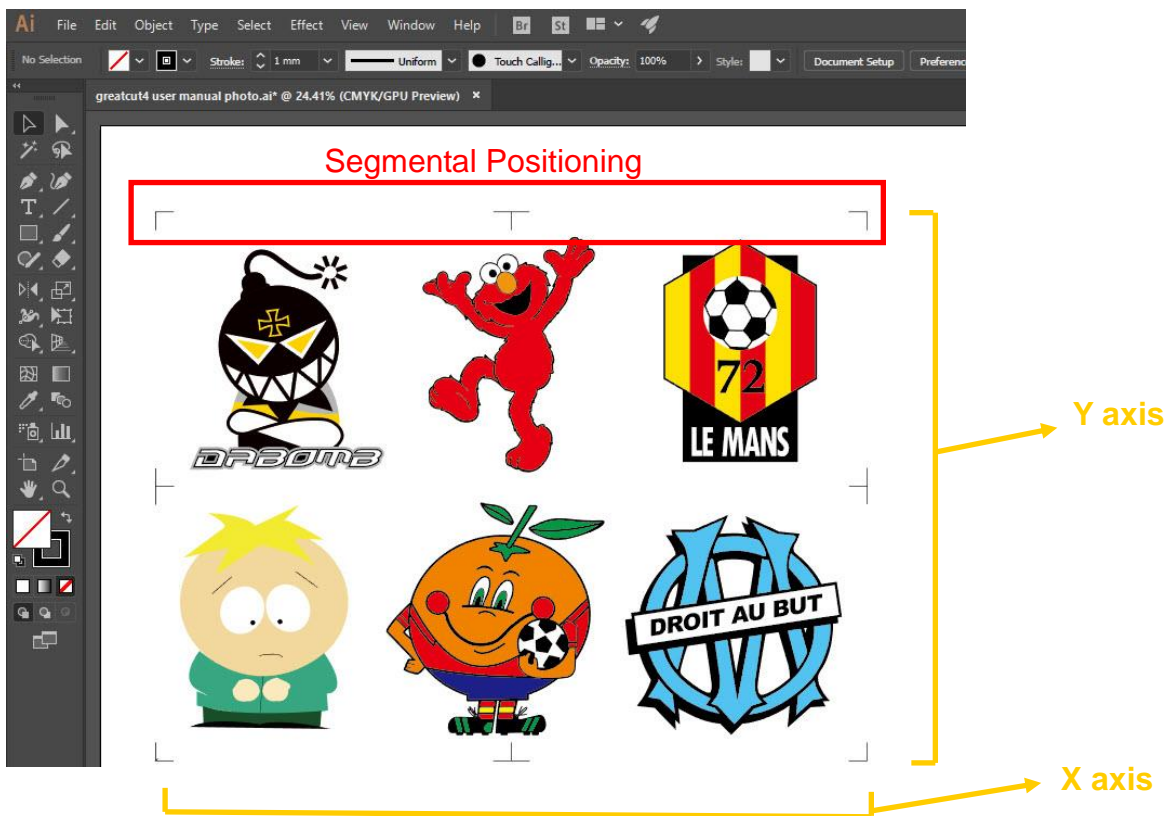
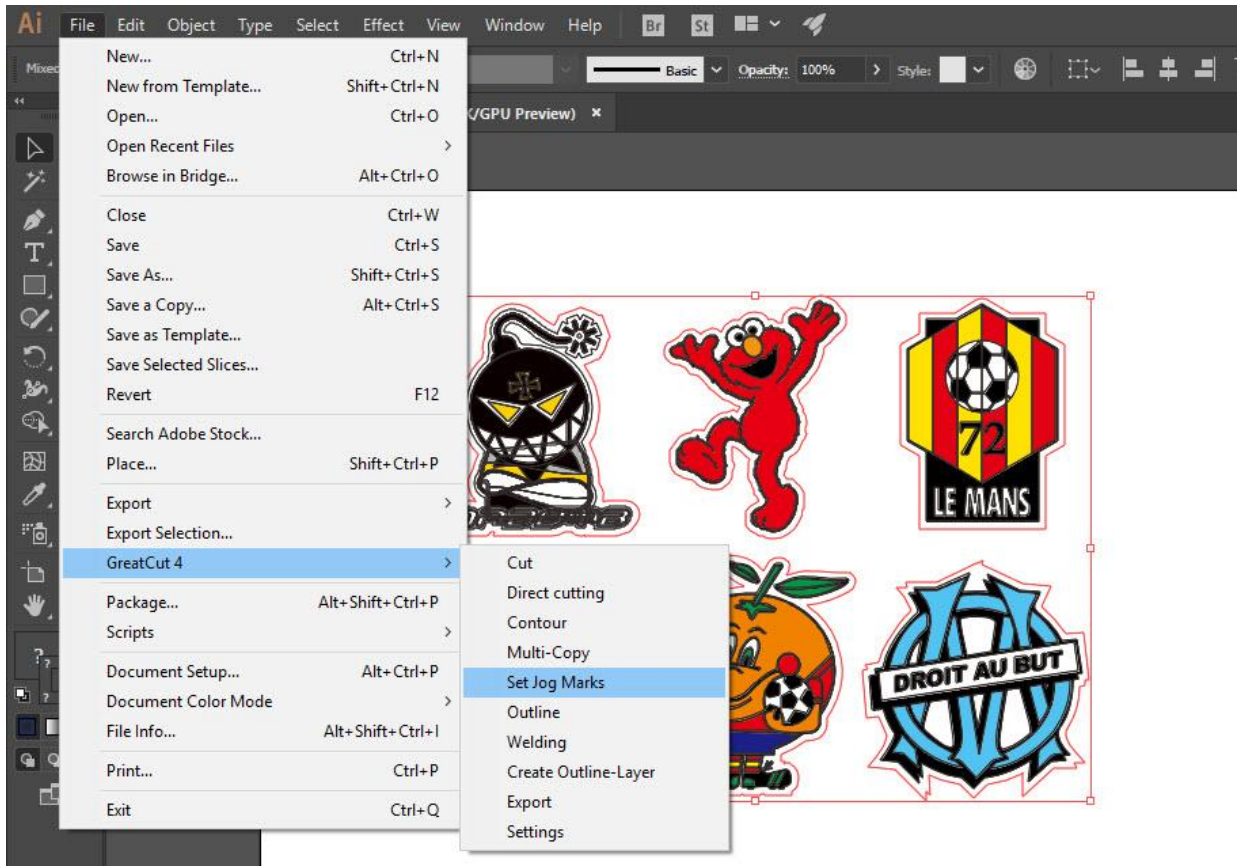

Multi-Copy

Step 1 Follow the same steps in the **4-Point Positioning** section to complete the contour line setting and registration mark creation procedures.

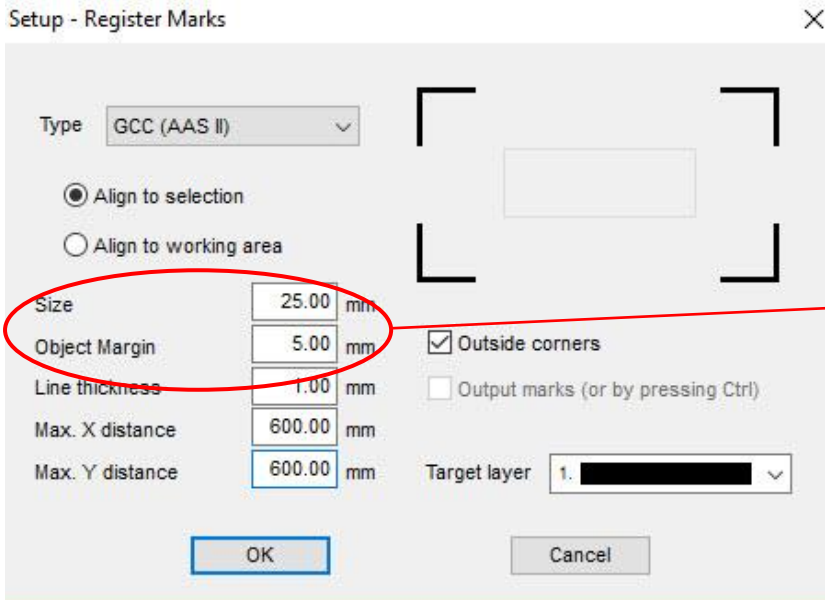

When you apply the “Multiple Copies” function, the value that has been set in this section will still be applied.

Step 2 Select the Set Jog Marks on GreatCut under File and 4 marks will be created as shown in the picture below.

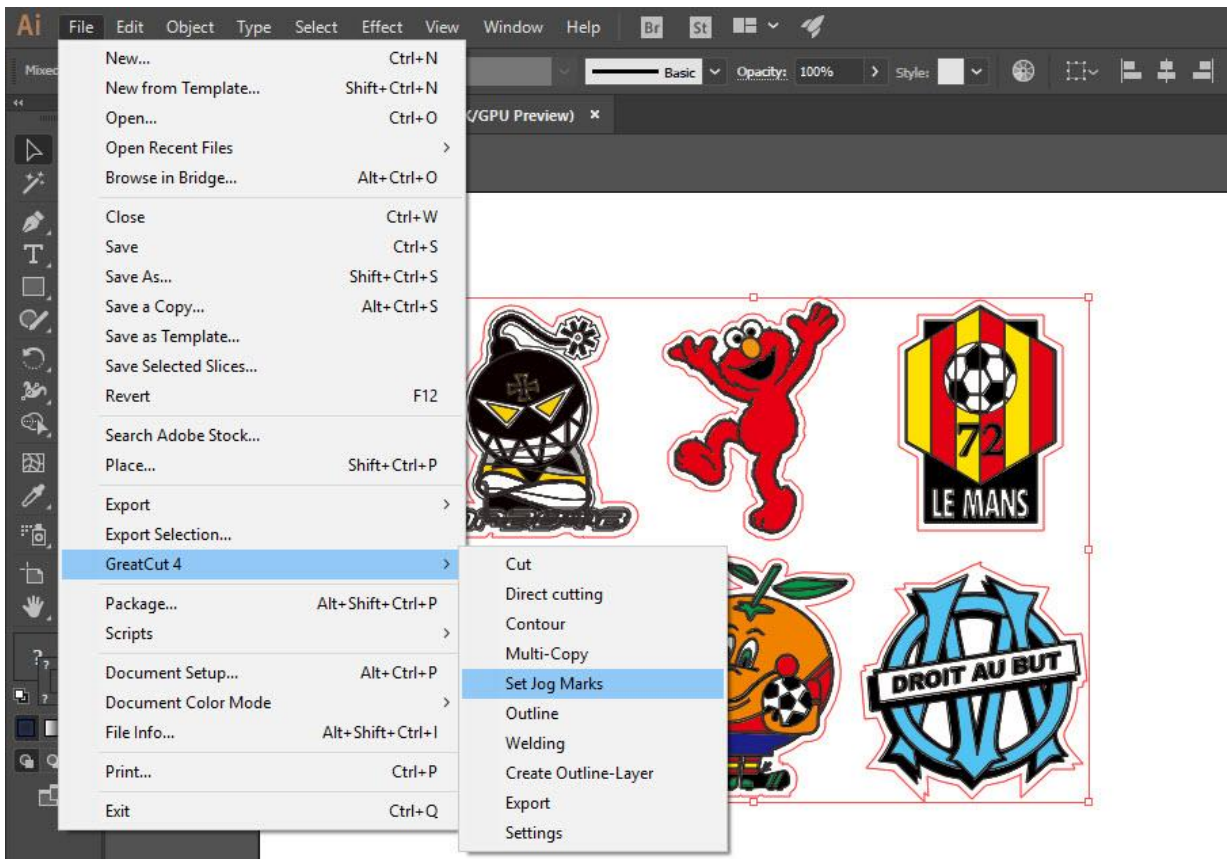



Step 3 Select both the entire object (including registration marks and the contour line) then click Cut on GreatCut under File.

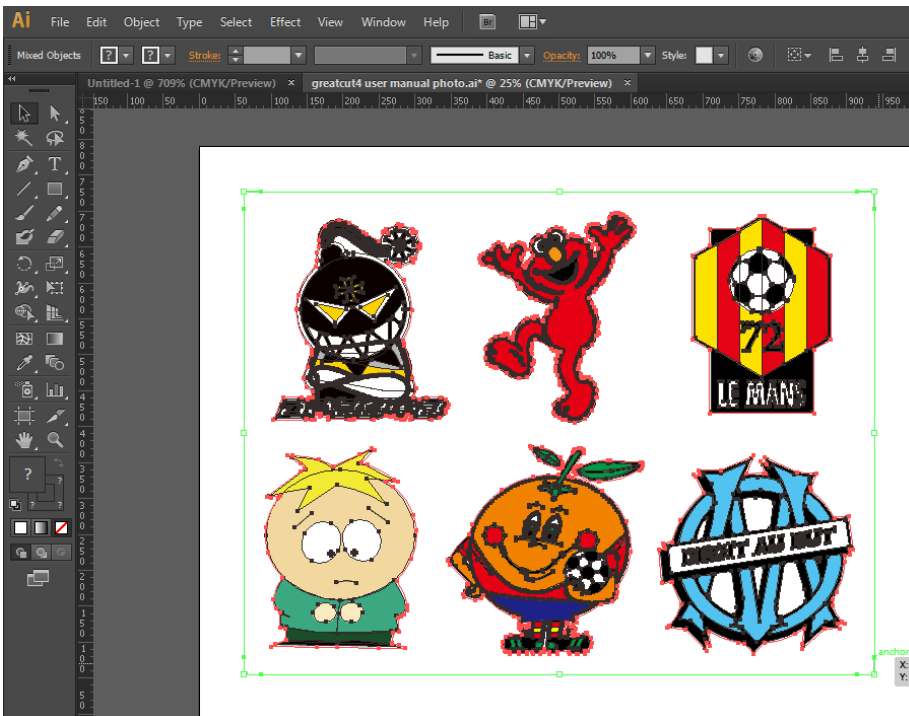

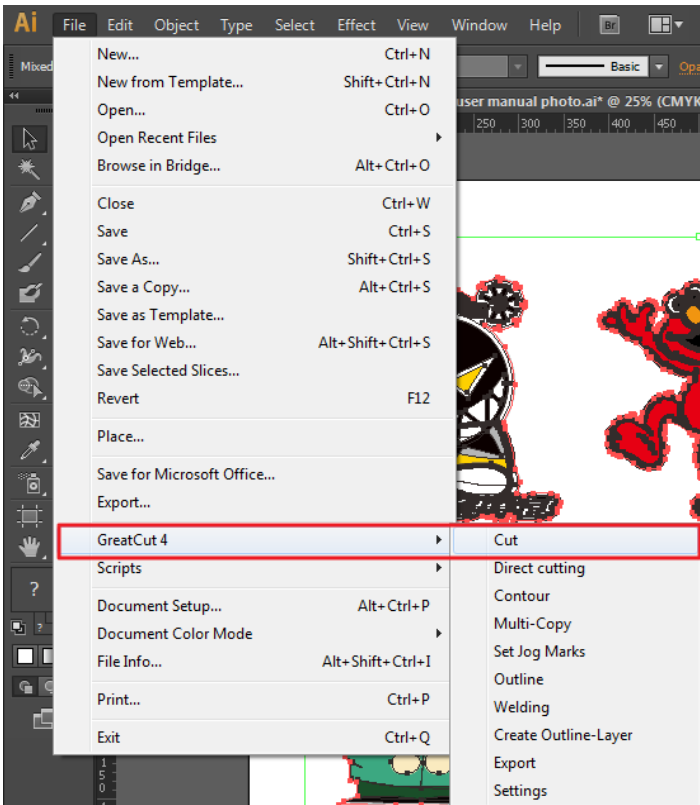

Step 4 The system will activate GreatCut automatically and import the registration marks and contour line to GreatCut.

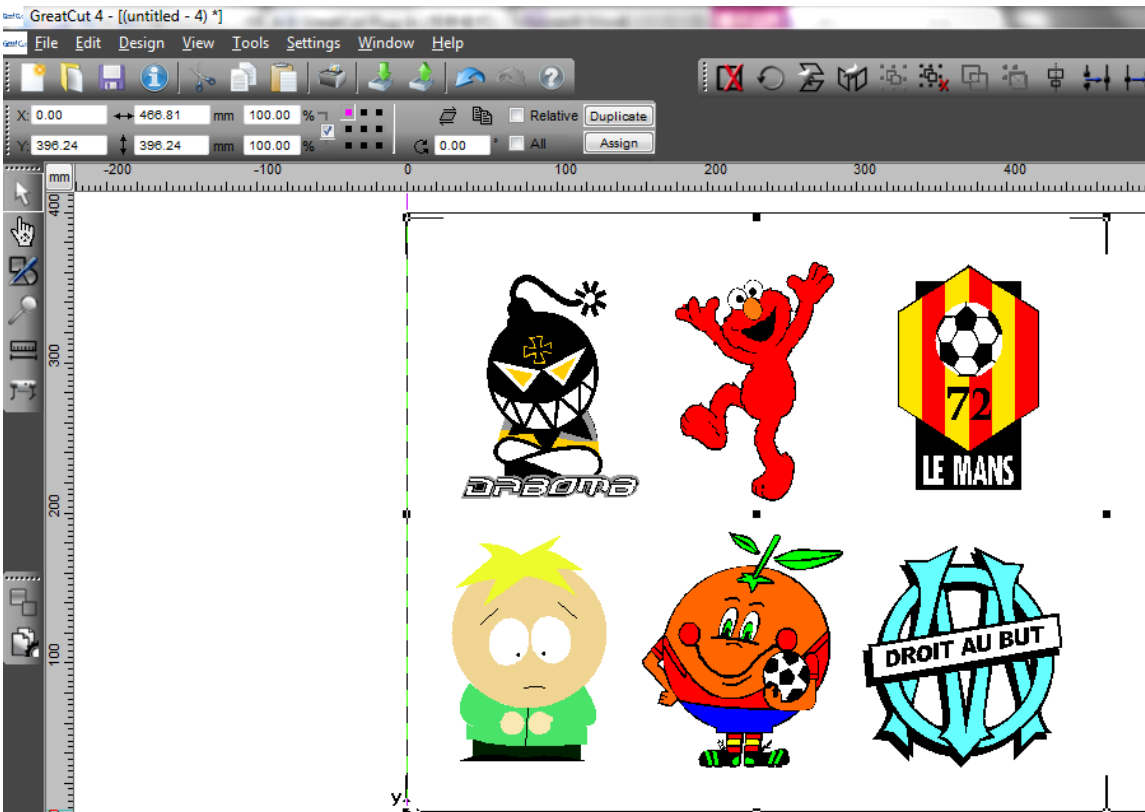

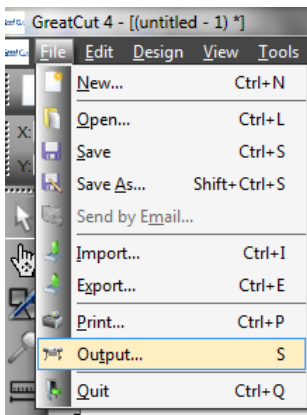
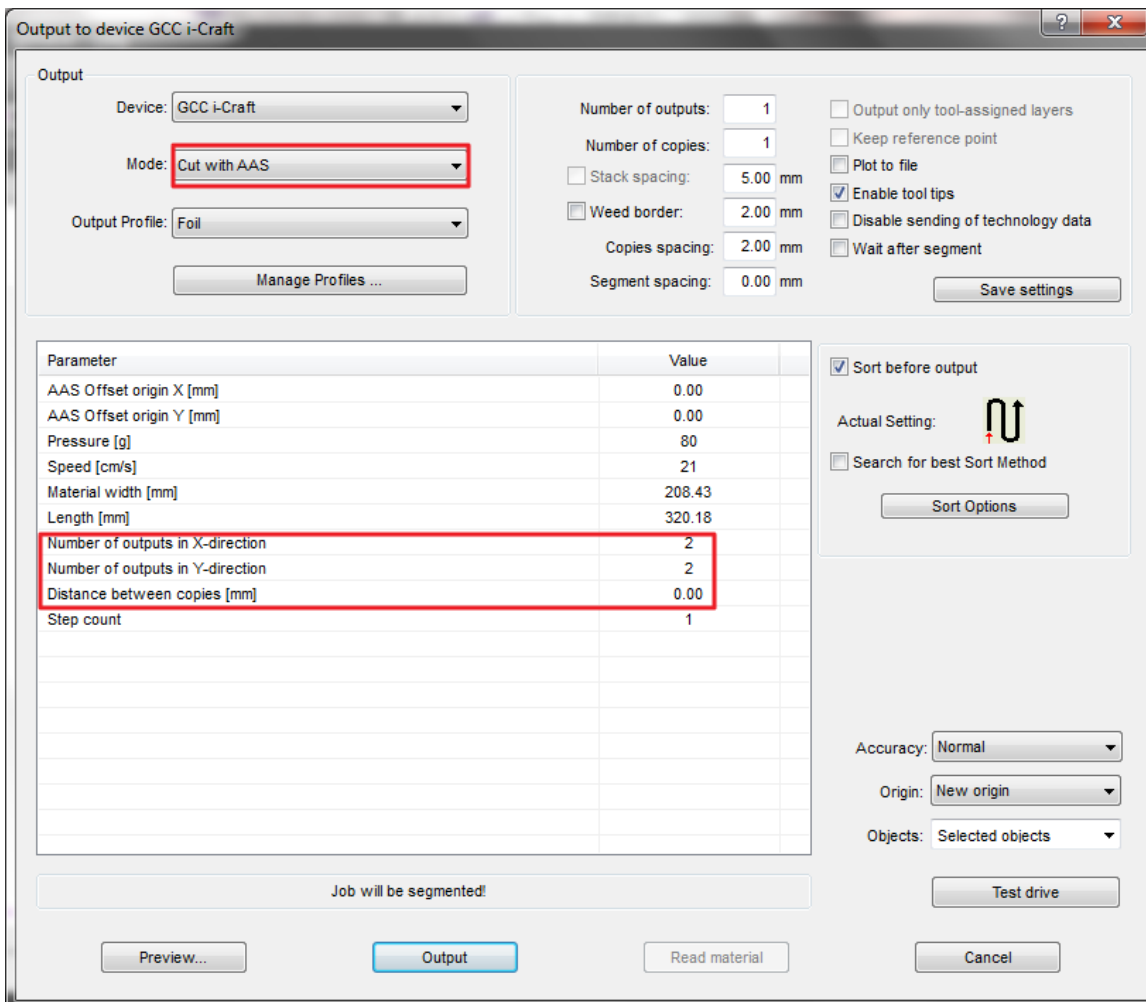
Step 5 Select Output under File.**Step 6** Select Mode as “Cut with AAS” and input the Number of outputs in X-direction and Y-direction and Distance between copies, please don't press output button.

Step 7 Back to Adobe Illustrator, Click Multi-Copy on GreatCut under File.

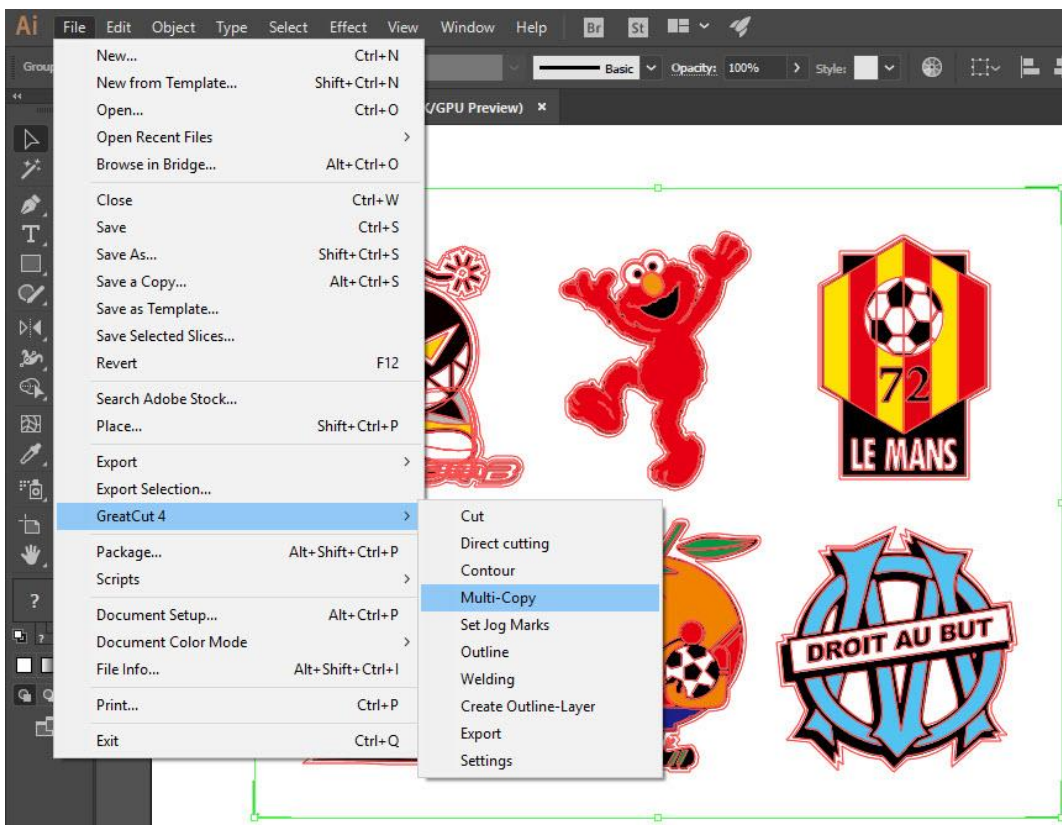

Step 8 Complete the Number in X/Y (the number of copies desired on the X/Y axis) and Distance in X/Y (distance between each copy) settings then click OK. Confirm that the value of Distance in X/Y must be the same with step 6.

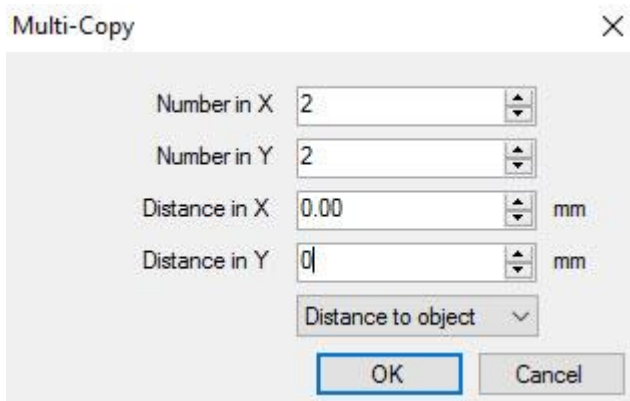

Note: The spacing of vertical & horizontal (Offset X & Y) should be $\geq 20\text{mm}$ or $= 0\text{mm}$; users are advised to set the Distance in X/Y as 0 mm to remove the space between each copy to avoid the waste of materials.

Step 9 The system will create several copies of the object with registration marks as shown in the picture below.

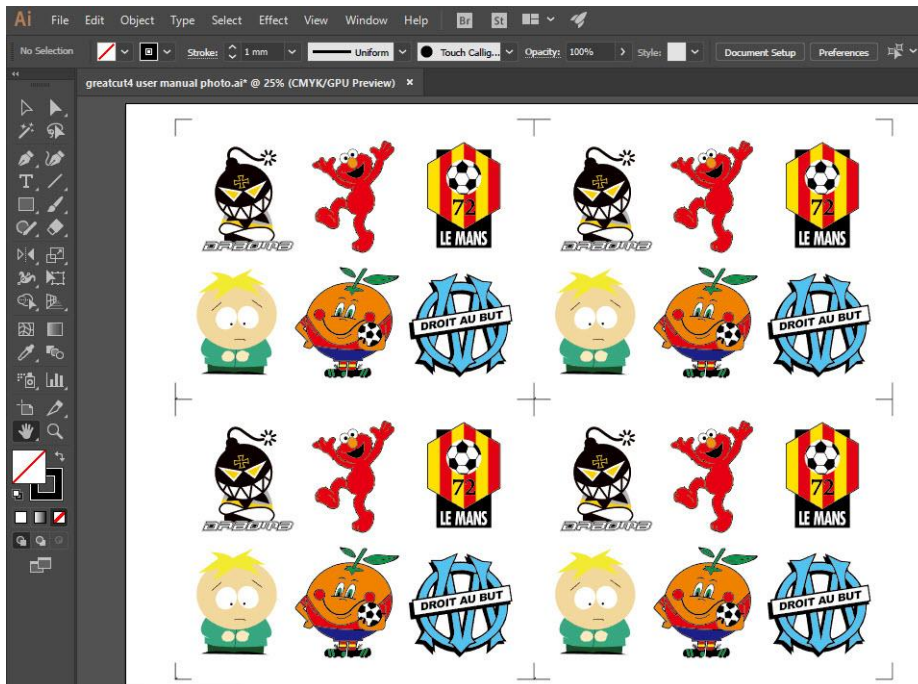

Step 10 Print the Multi-Copy images out, and put the printed media on the GCC cutting plotter.

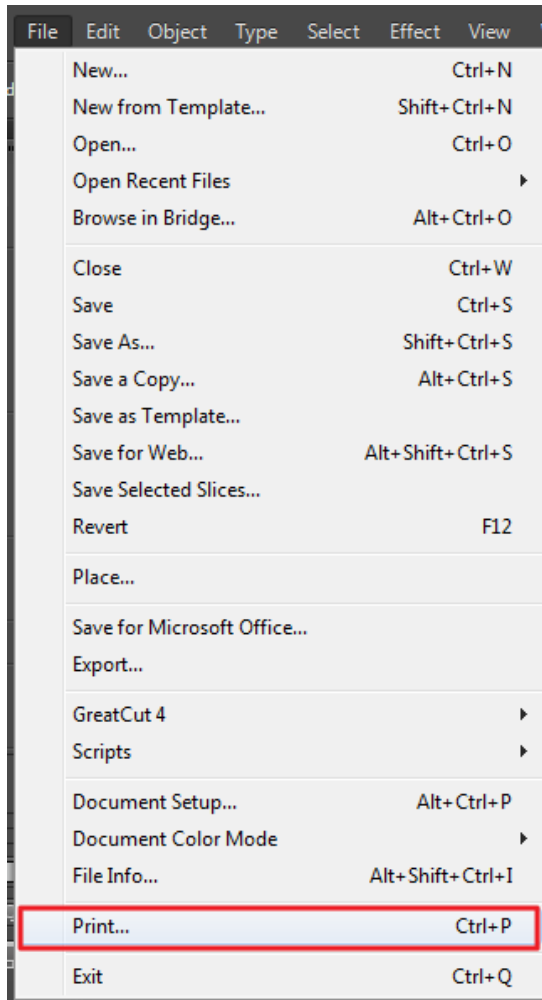

Step 11 Go to GreatCut window, press Output button.

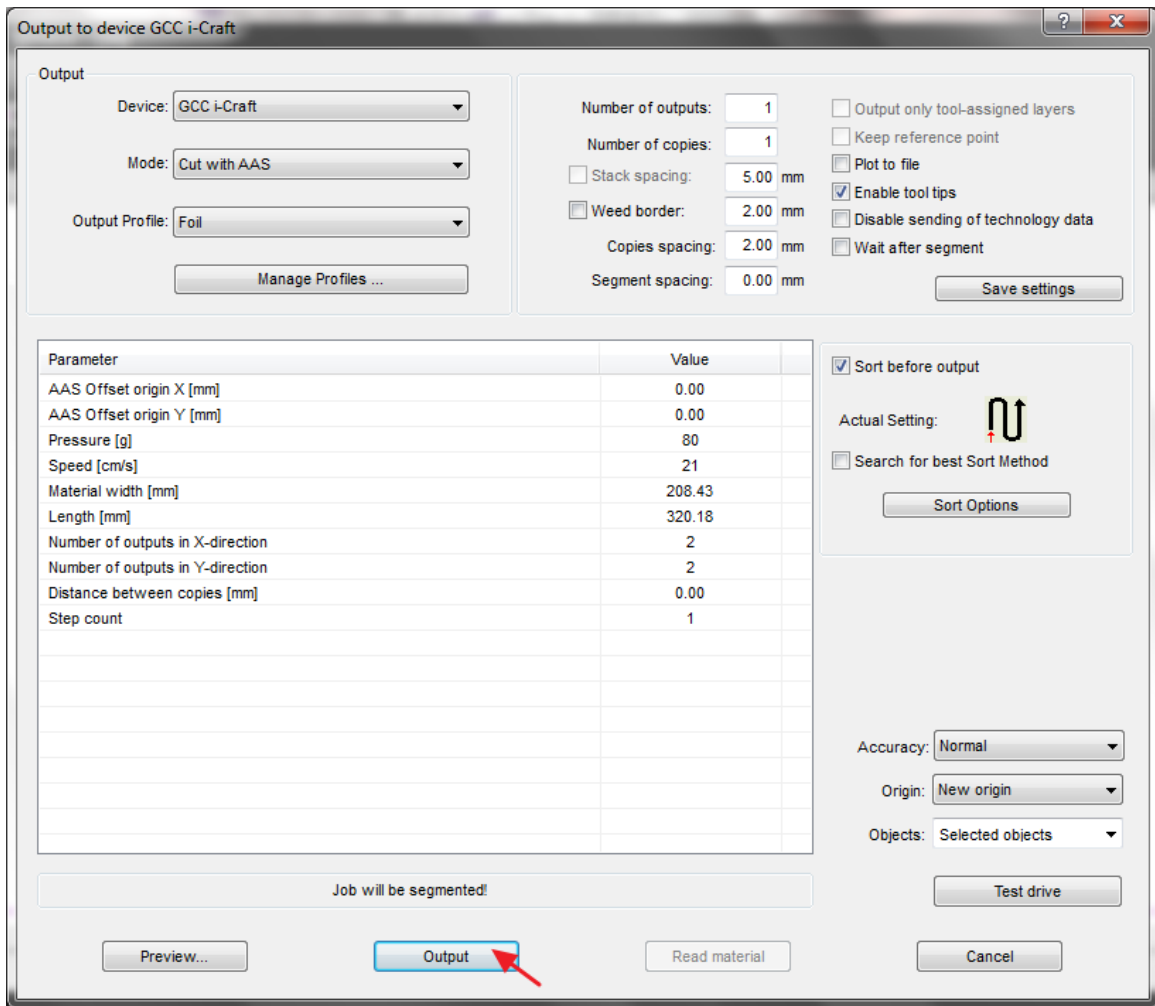

SignPal 12 Instruction

The SignPal 12 Software is Windows System compatible and all versions support the AAS II contour cutting function.

SignPal 12 Instruction Index:

- [1] Installing the SignPal 12 software
- [2] Set up your GCC Cutter on Production Manager
- [3] SignPal AAS II Quick Start
- [4] SignPal 12 Features List

[1] Installing the SignPal 12 software

To install the software, you must have Administrator privileges. To use the software, you must have Administrator or Power User privileges. See your Windows user guide for more information.

1. Uninstall any previous version of the software.
2. Go to GCC Club (<http://gccf.gcc.com.tw/gccclub/login.aspx>) and login, and select **Drivers > Cutter > Others > SignPal 12** to download the WinRAR file.

The screenshot shows the GCC Club website interface. On the left is a navigation menu with the following items: Tech Support, Drivers (highlighted with a red box), User Manual, Clipart Download, Product Video, Showcase, Product Registration, and GCC Bonus Credit (North America). The main content area is titled 'Drivers' and contains a message: 'Below you will find drivers for GCC cutting plotters and ID card printers. Simply choose from the selections below and press the "Download" button. As to laser engraving/cutting/marketing systems or other products, please contact your local distributors for further assistance.' Below this message are three dropdown menus labeled Step 1, Step 2, and Step 3. Step 1 is set to 'Cutter', Step 2 is set to 'Others', and Step 3 is open, showing a list of options: GreatCut 3 v16.0.10, SignPal 10.5.1, SignPal 12 (highlighted with a red box), and VCCB v2.05-01. A 'Please note' section below the dropdowns states: 'For some of the driver(s) version might cause problem(s) on your system. To ensure the correct version on your system, please contact your local supplier for support before you update your system.' A 'Download' button is located at the bottom right of the page.

3. Follow the installation and activation instruction for SignPal 12 below.

(1) Install and activate software on an online computer

1. Launch your browser and type <https://www.saicloud.com> in address bar and press enter, then input your activation code, then click **Activate**, activation code can be found in the code label in software package.

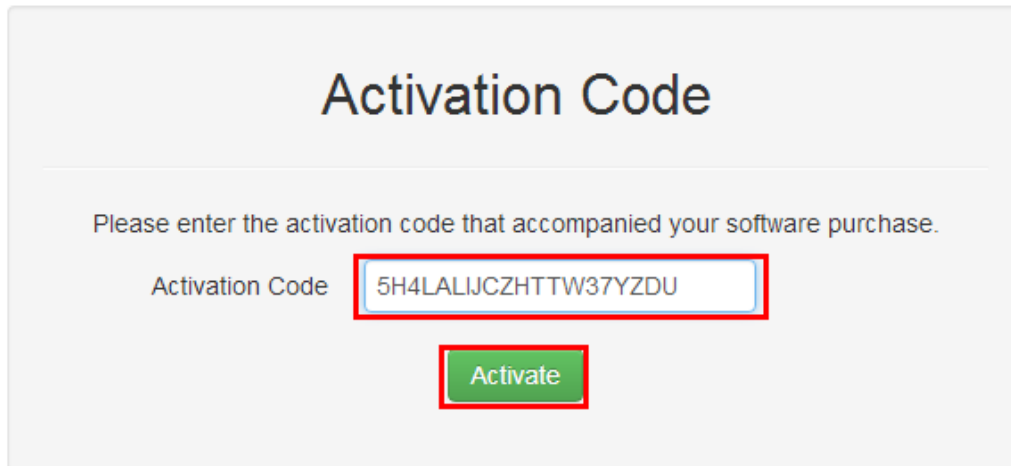

Activation Code

Please enter the activation code that accompanied your software purchase.

Activation Code

2. In login section, click **I am new to the SAi Cloud** and input your email address, then click **Create Account**, an email will be sent to your mailbox.

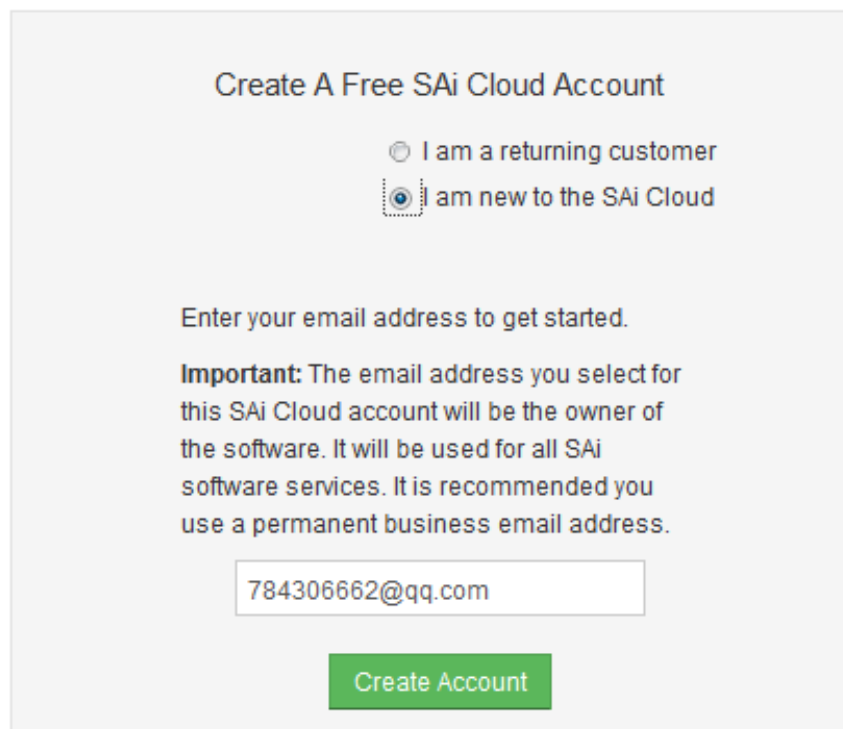

Create A Free SAi Cloud Account

I am a returning customer

I am new to the SAi Cloud

Enter your email address to get started.

Important: The email address you select for this SAi Cloud account will be the owner of the software. It will be used for all SAi software services. It is recommended you use a permanent business email address.

3. Check your mailbox and click website link in the email then complete the information fields.

Create Account

*** Email**

*** Password**
Password must be at least 5 characters

*** Retype Password**

*** Name**

*** Company Name**

*** Country**

*** Time Zone**

Address Line 1

Address Line 2

City

State/Province

Zip/Postal

Terms And Conditions

Terms and Conditions

User Agreement

IMPORTANT—READ CAREFULLY:

This Account User's Agreement is a legal contract between You (defined below) and SA International Inc.

BY USING YOUR SAI CLOUD ACCOUNT, YOU (AS THIS TERM IS DEFINED BELOW) AGREE BY CLICKING ON THE "ACCEPT" BUTTON TO BE BOUND BY THE TERMS OF THIS AGREEMENT (AS THIS TERM IS DEFINED BELOW), INCLUDING, BUT NOT LIMITED TO, ANY WARRANTY DISCLAIMERS, LIMITATIONS OF LIABILITY, JURISDICTION, AND TERMINATION PROVISIONS. IF YOU DO NOT AGREE TO THE TERMS OF THIS AGREEMENT, DO NOT OPEN AN SAI CLOUD ACCOUNT AND EXIT NOW

Article I. Defined Terms:

1. Account means your account on the SAI Cloud
2. Agreement means this End-User Account Agreement.
3. Entity means any individual, partnership, joint venture, corporation, limited



Step 2. Add Software to your SAI Cloud Account

Add To SAI Cloud Account

This software license will be added to your SAI Cloud Account.

4. Open **Autorun** in the WinRAR file. Then install software step by step by following the wizard.

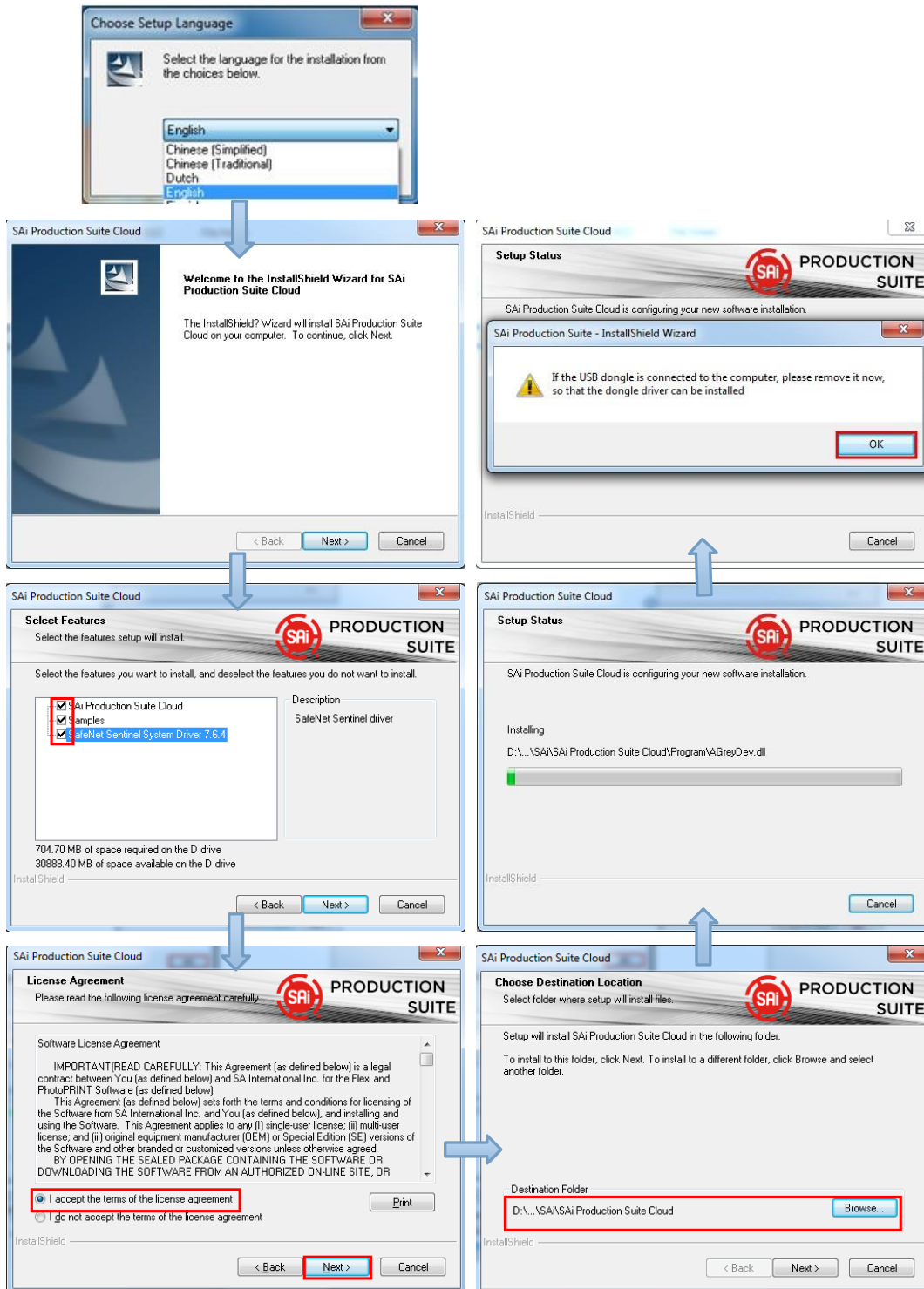

5. Paste your code into activation code field.

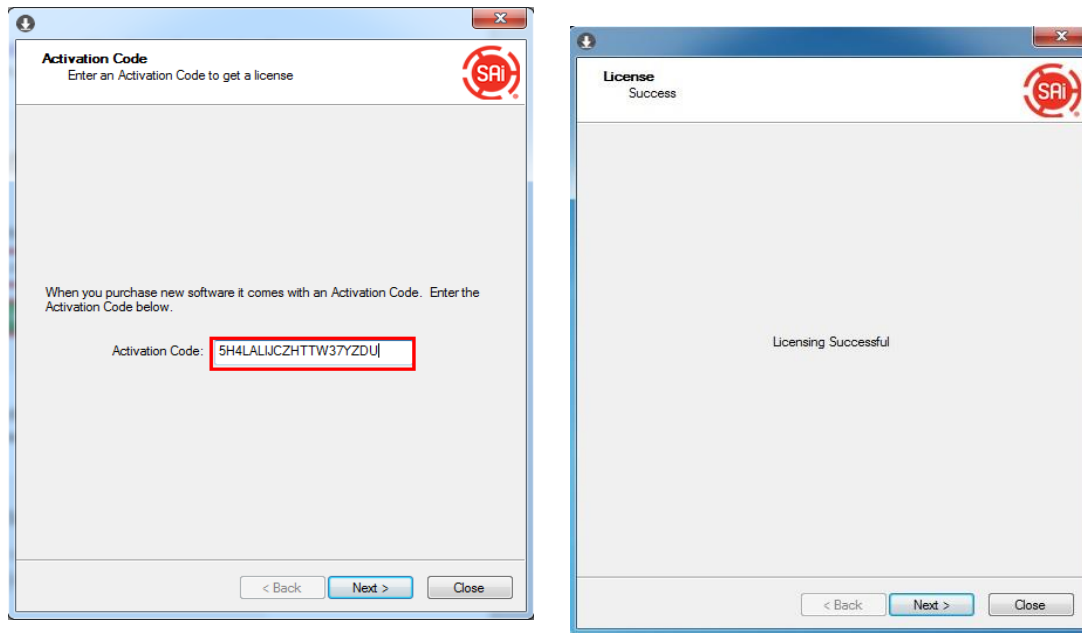

6. Select language you need, click **OK** and finish installation.

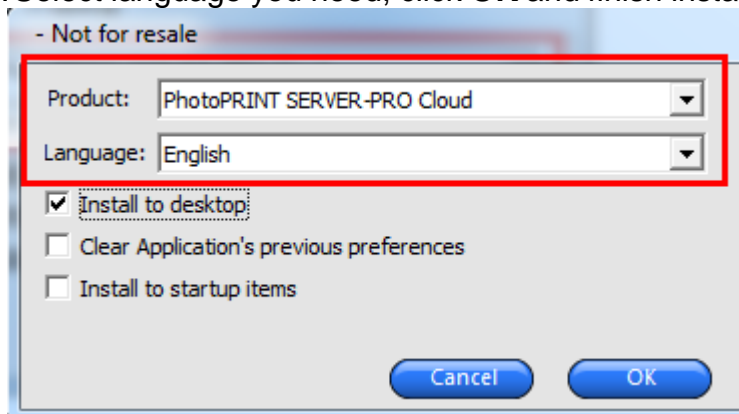

(2) Install and activate software on an offline computer

1. Open **Autorun** in the WinRAR file. Then install software step by step by following the wizard.

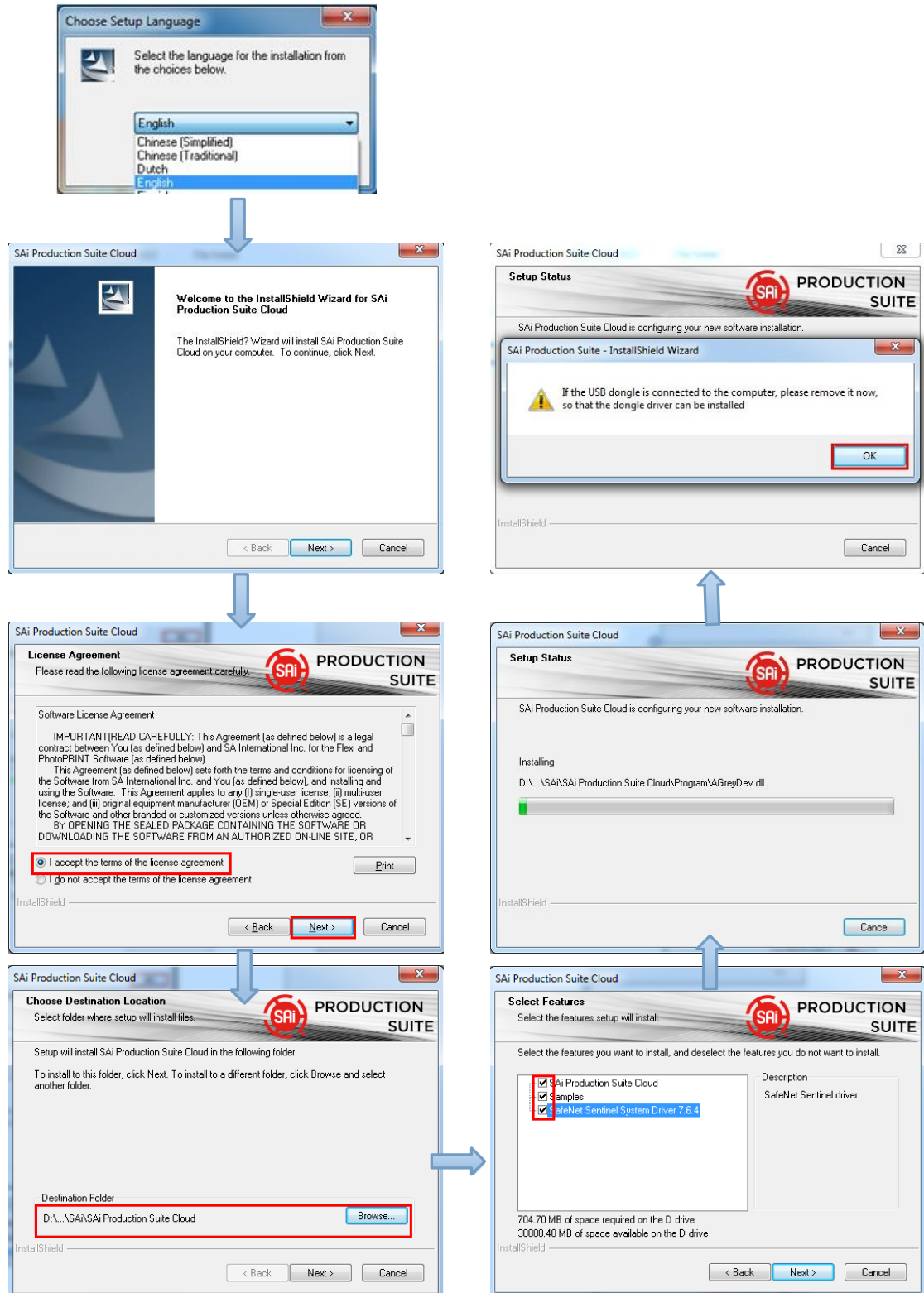

- Record your computer ID in the dialog box below and look up your computer name, You can find your computer name by right-click on **My Computer** and choose **Properties**.

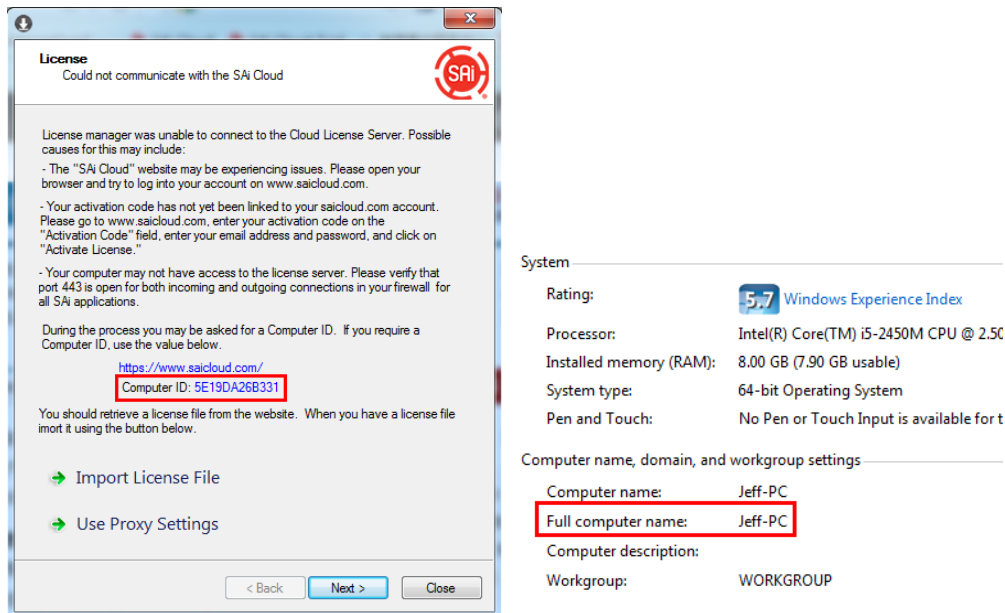

- Launch your browser on another online computer and type <https://www.saicloud.com> in the address bar and press enter, then input your activation code and click **Activate**.
The Activation code can be found in the software package certificate.

Activation Code

Please enter the activation code that accompanied your software purchase.

Activation Code

4. In login section, click **I am new to the SAi Cloud** and input your email address, then click **Create Account**, an email will be sent to your mailbox.

Create A Free SAi Cloud Account

I am a returning customer
 I am new to the SAi Cloud

Enter your email address to get started.

Important: The email address you select for this SAi Cloud account will be the owner of the software. It will be used for all SAi software services. It is recommended you use a permanent business email address.

5. Check your mailbox and click website link in the email then complete the information fields.

Step 2. Add Software to your SAi Cloud Account

Add To SAi Cloud Account

This software license will be added to your SAi Cloud Account.

6. Click **“License Manager” can’t connect** and input your computer ID and computer name that you recorded for the offline computer before, then click **Create license Now** and **Download License**, save license file to local.

Step 1 - Download
Clicking on the download button below will download a small application. Run the application to do

[Download Now](#)

Step 2 - Install
Once the download is complete, run the installer. The final step in the install process will run a "Lic application.

Step 3 - License
The "License Manager" application will ask for an activation code. Use the activation code below to

QTP5NDB8FXUYUXGXHLTA6

"License Manager" can't connect?



Create License

[Go Back](#)

Your software will be licensed to be used on the computer wit

Computer ID

Computer Name

[Create License Now](#)



Current Install

Computer ID: 5E19DA26B331

Computer Name: JEFF-PC

User Name: Administrator

Mar 21, 2014

[Download License](#)

[License Removed?](#)

[Download Now](#)

7. Copy license file to offline computer via a removable disk device, then import it.

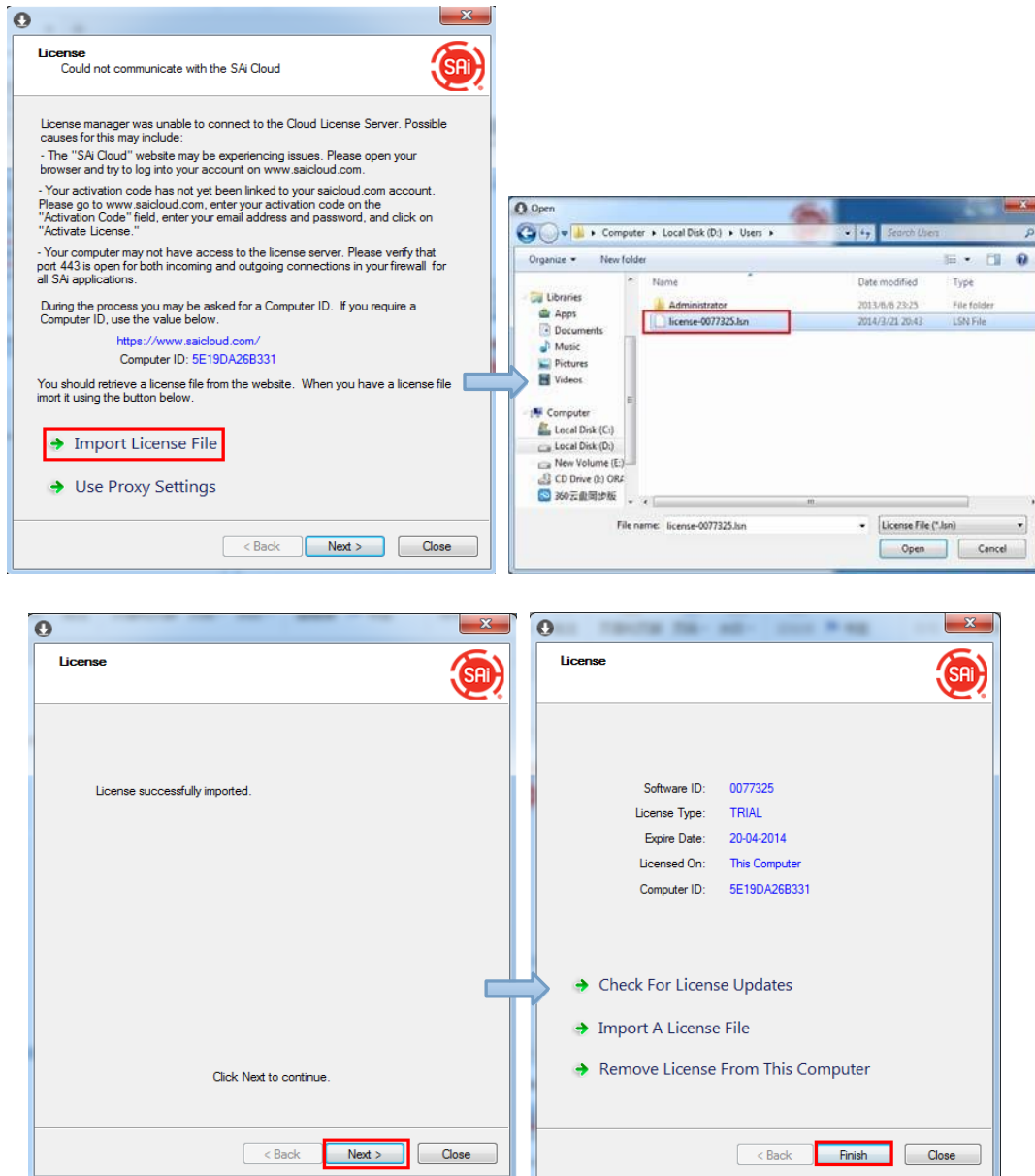

8. Select language you need, then click **OK** and finish installation.

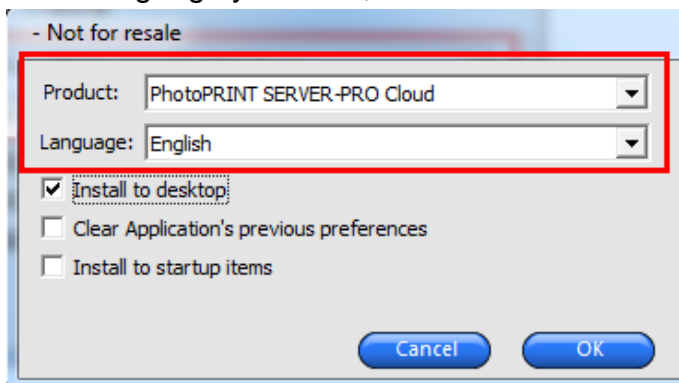

(3) Transfer license on an online computer

1. Open **License Manager** from **Start** menu.

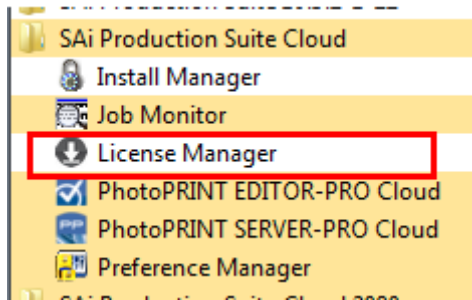

2. Click **Remove License From This computer**, Now you can install the software on another computer.

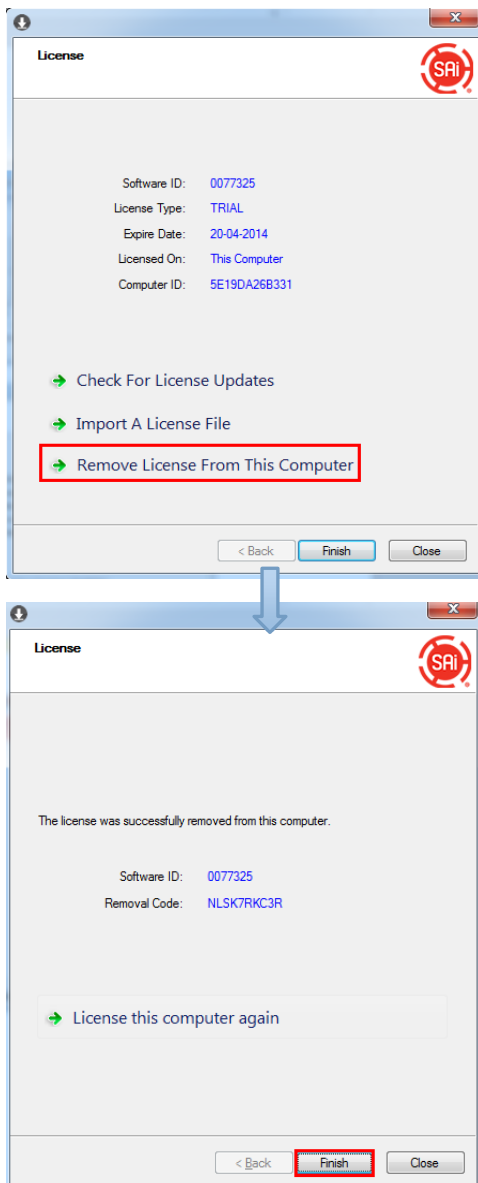

(4) Transfer license on an offline computer

1. Open **License Manager** from **Start** menu.

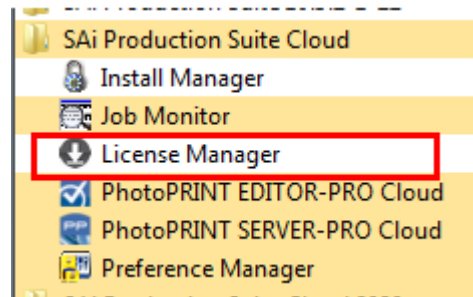

2. Click **Remove License From This computer**, then record removal code in license dialog box.

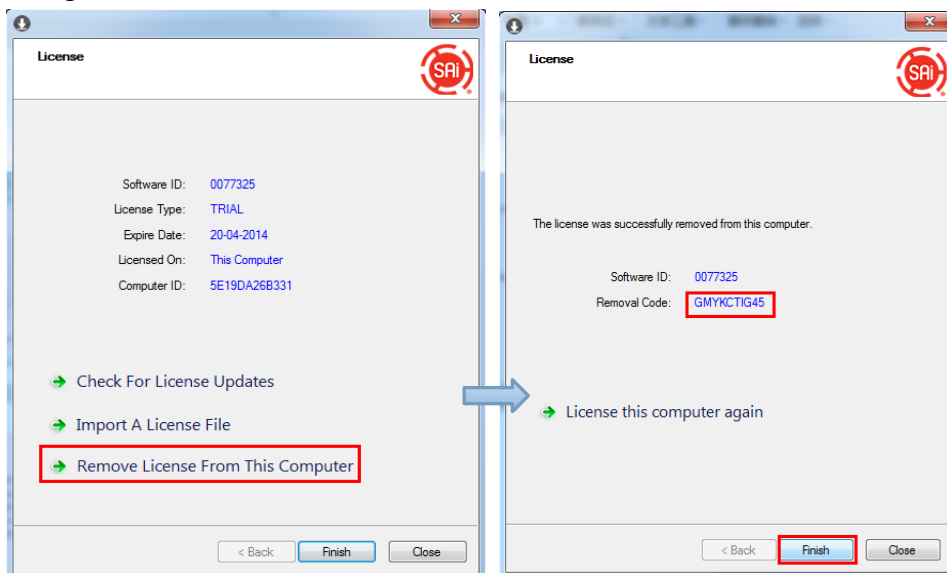

3. Launch your browser on another online computer, access <https://www.saicloud.com> and login with your account. Click **License Removed** then input removal code and click **Remove**. After this you can install software on another computer.

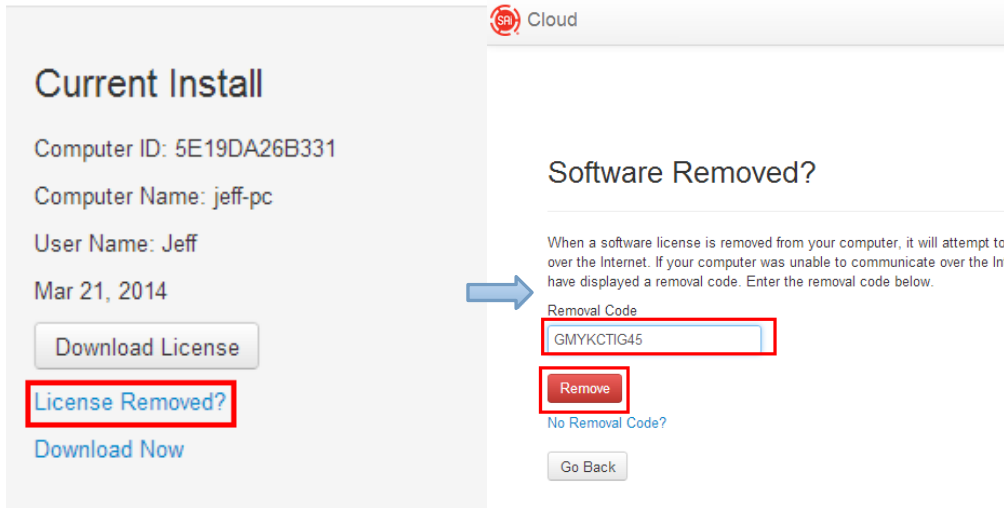

[2] Set up your GCC Cutter on Production Manager

1. Open Production Manager 12
2. Choose and set up your GCC cutter.

(Note that AAS II System only works on RX II, Jaguar V LX, Puma III, Expert II LX models.)

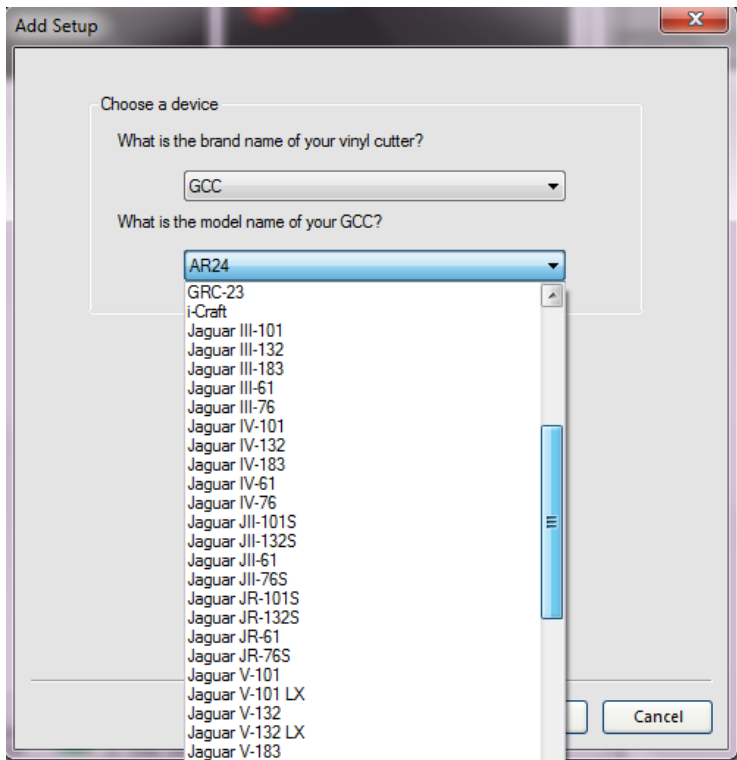

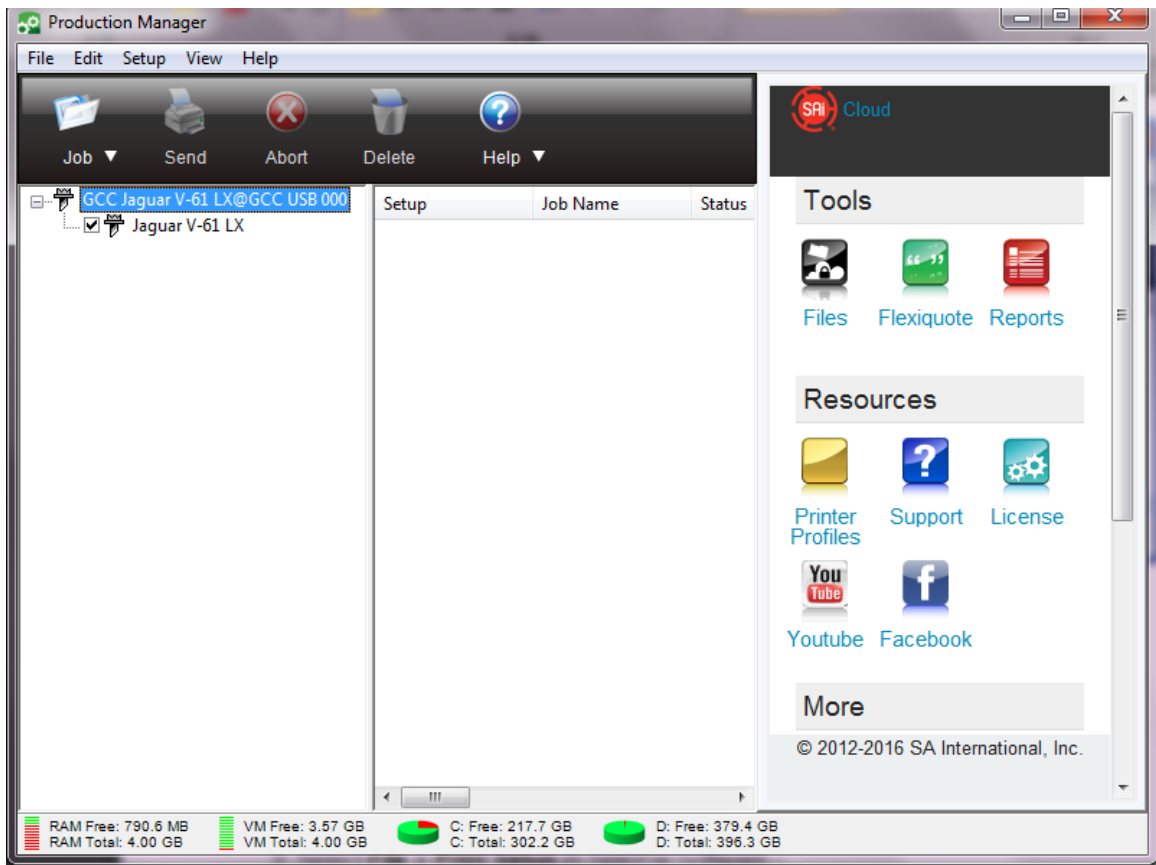
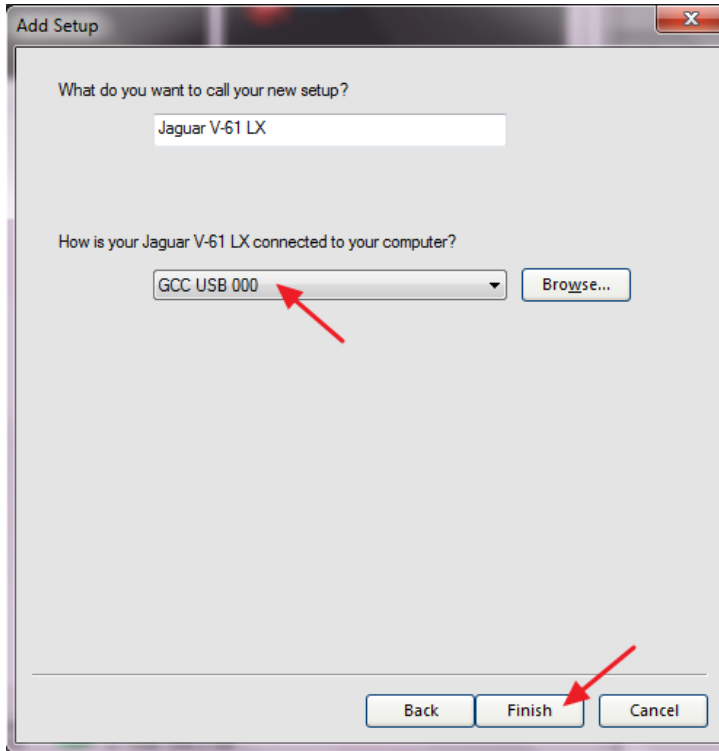

3. Select **File > Print Setup** in SignPal Software and select the printer.

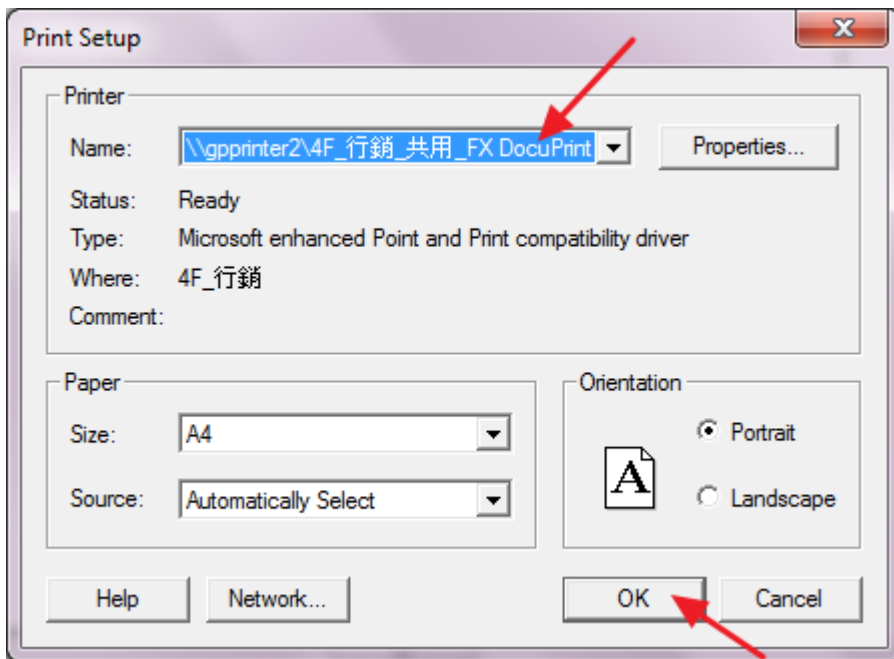
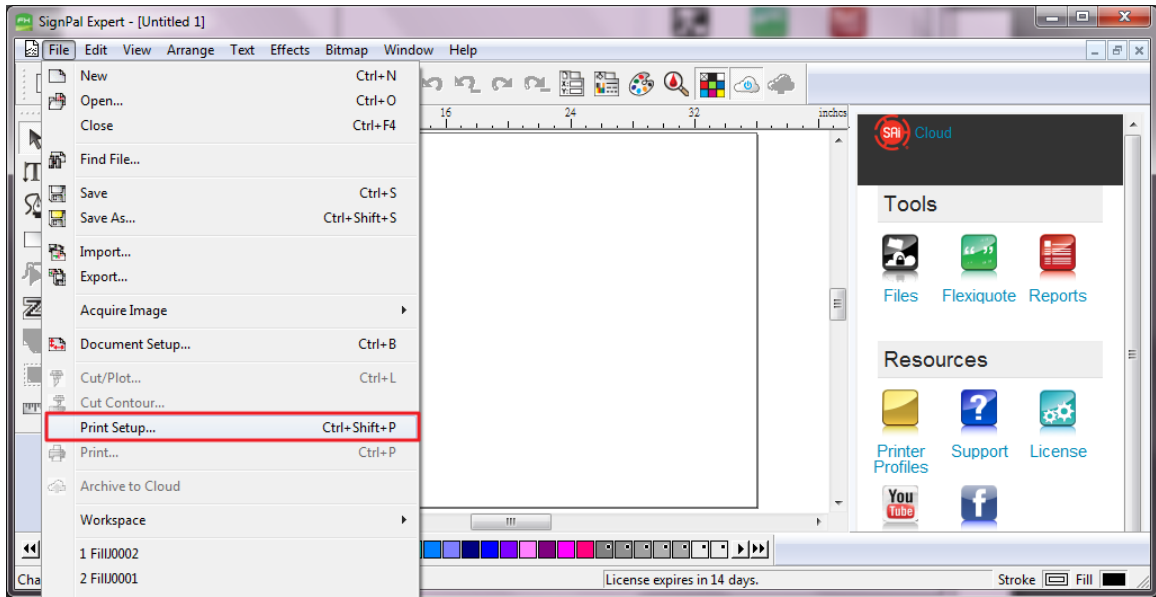

4. Select **File > Document Setup** in SignPal and select paper size .

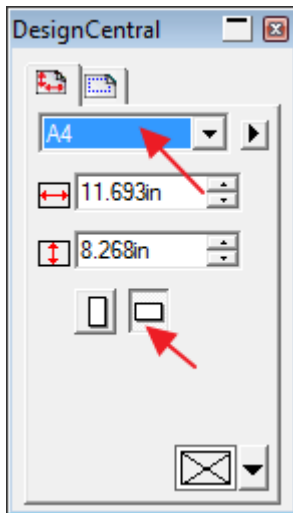
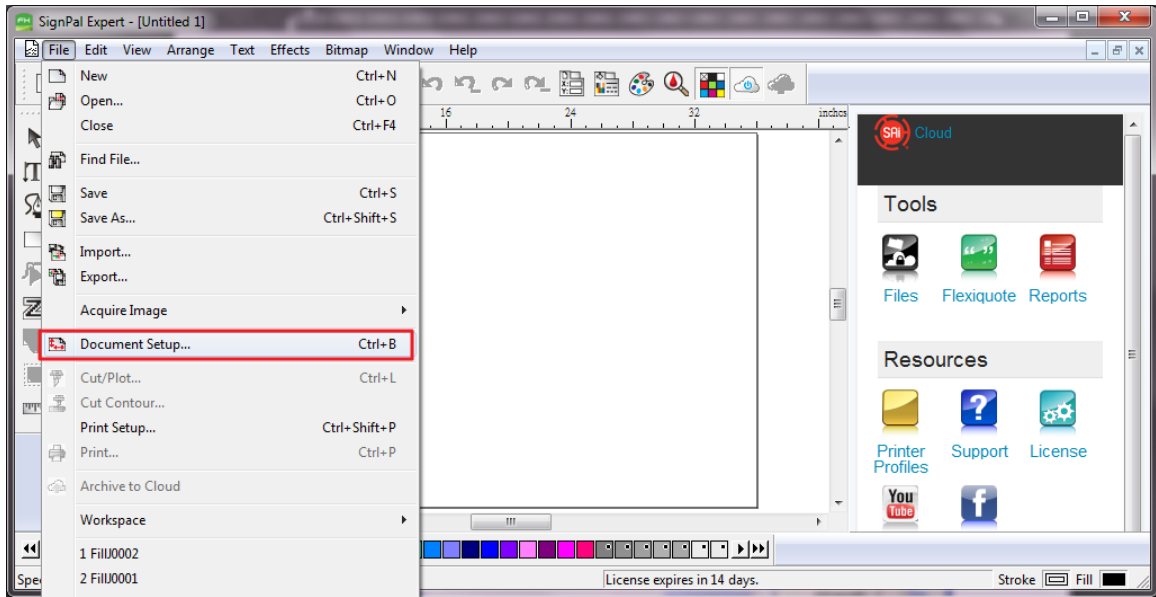

[3] SignPal AASII Quick Start

1. Use the **Rectangle Tool** to create a rectangle.

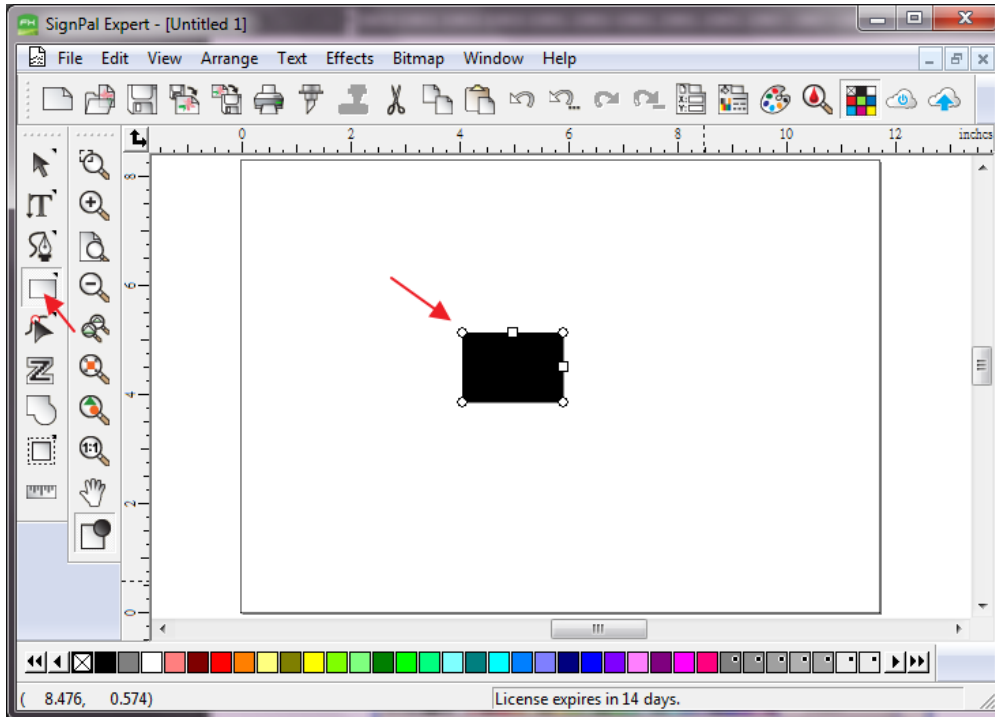

2. Select **Effect > Contour Cut**. Then click 'Apply' in DesignCentral window.

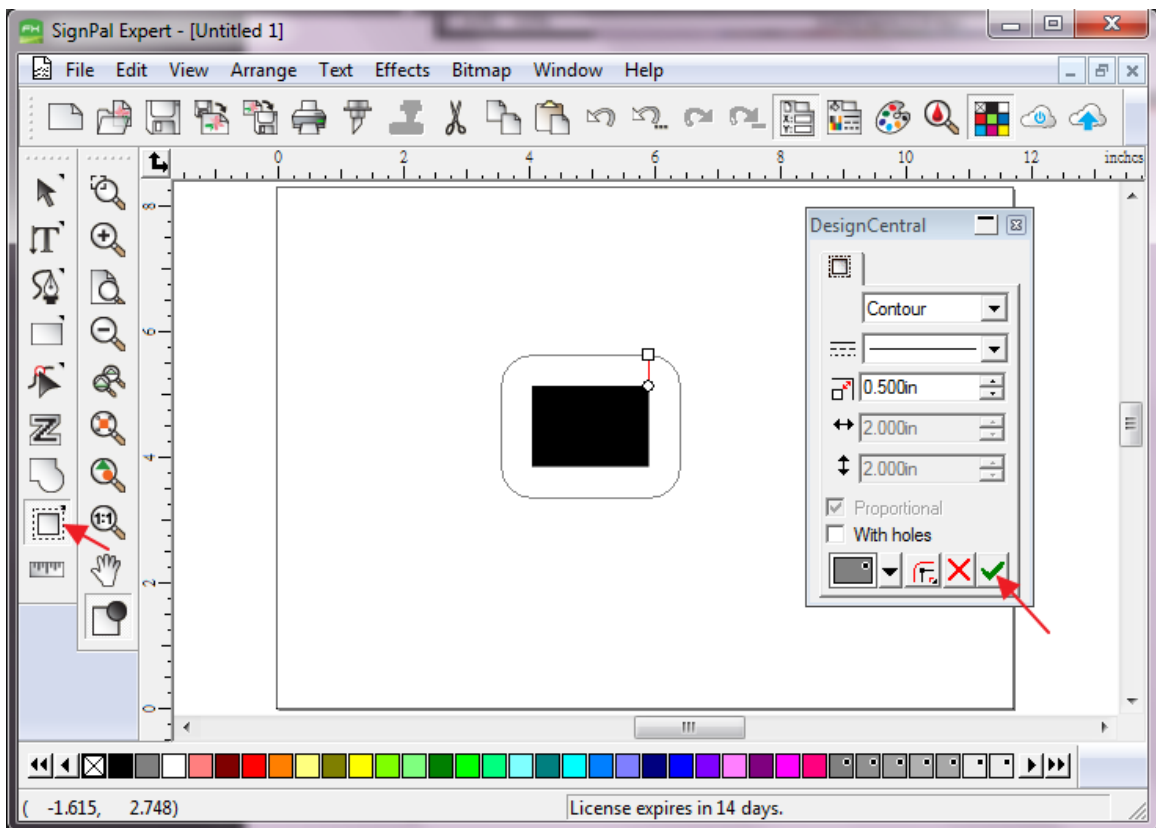

3. Apply the contour cut mark of GCC AASII by selecting **Effect > Contour Cut Mark**.

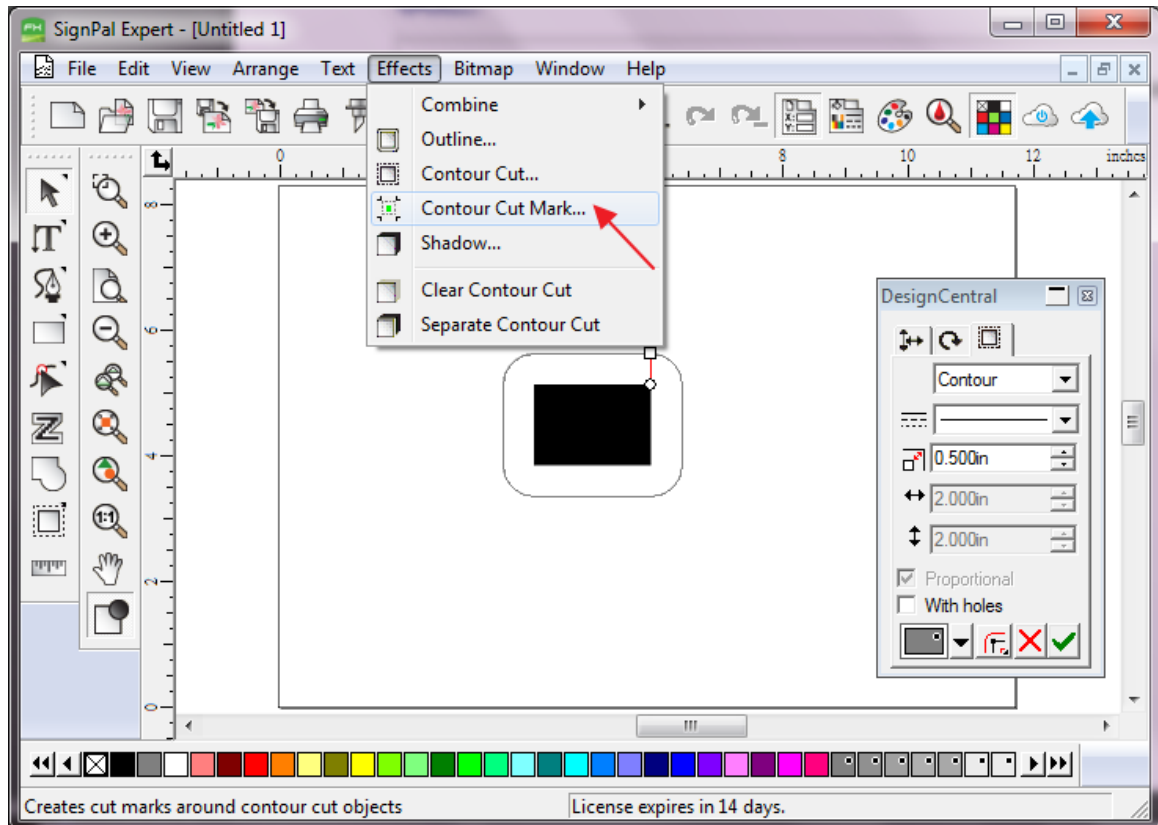

4. Select “**GCC AASII**” in SignPal DesignCentral window to create the AAS II registration marks (4-Point Positioning) and click ‘**Apply**’ in DesignCentral window.

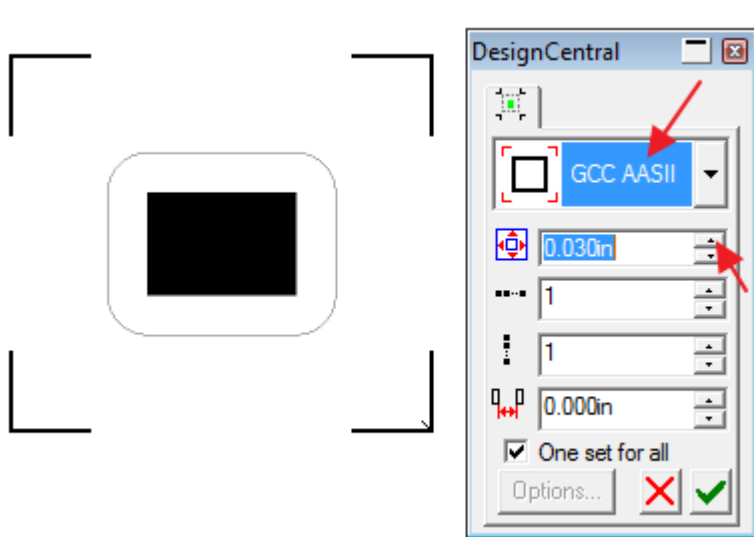

5. There are three types of GCC AASII registration marks: 4-Point Positioning, Segmental Positioning, and Multiple Copies. To make 'Segmental Positioning' marks, please select "**GCC Segmentation**" in DesignCentral window and then click '**Apply**'.

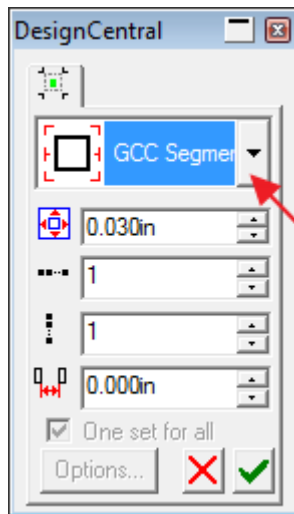

6. For 'Multiple Copies', this function is not available in SignPal. Currently the 'Multiple Copies' function is only available under CorelDraw plug-in.

7. Select **File > Print** to print out the image.

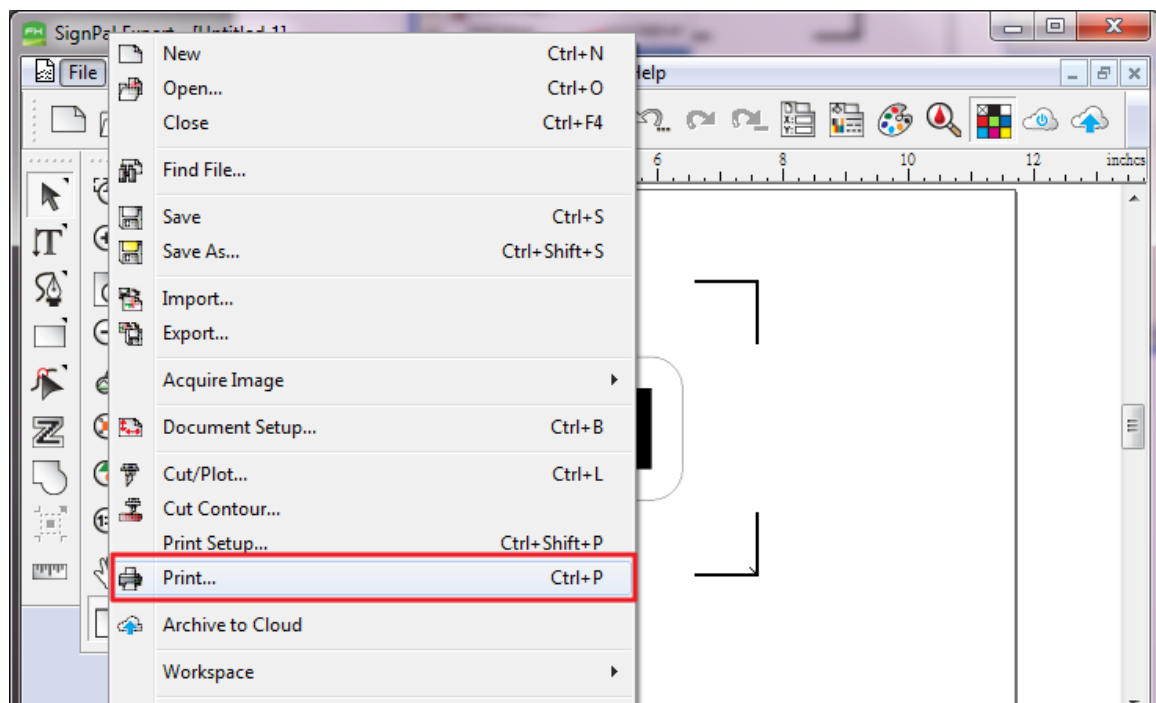

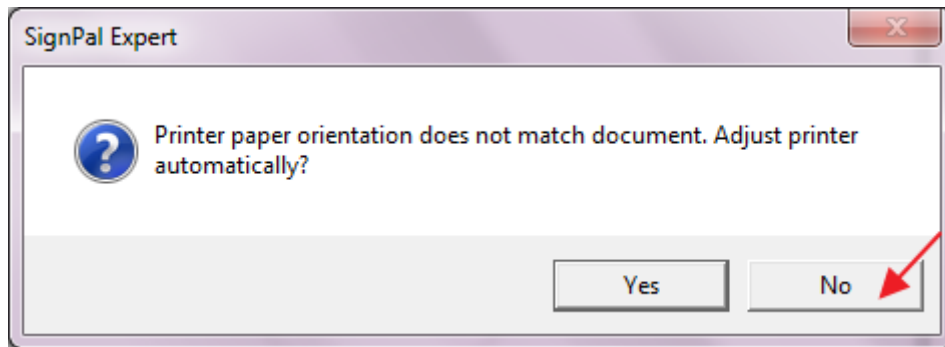

8. Set the Scale as 100% in Print page.

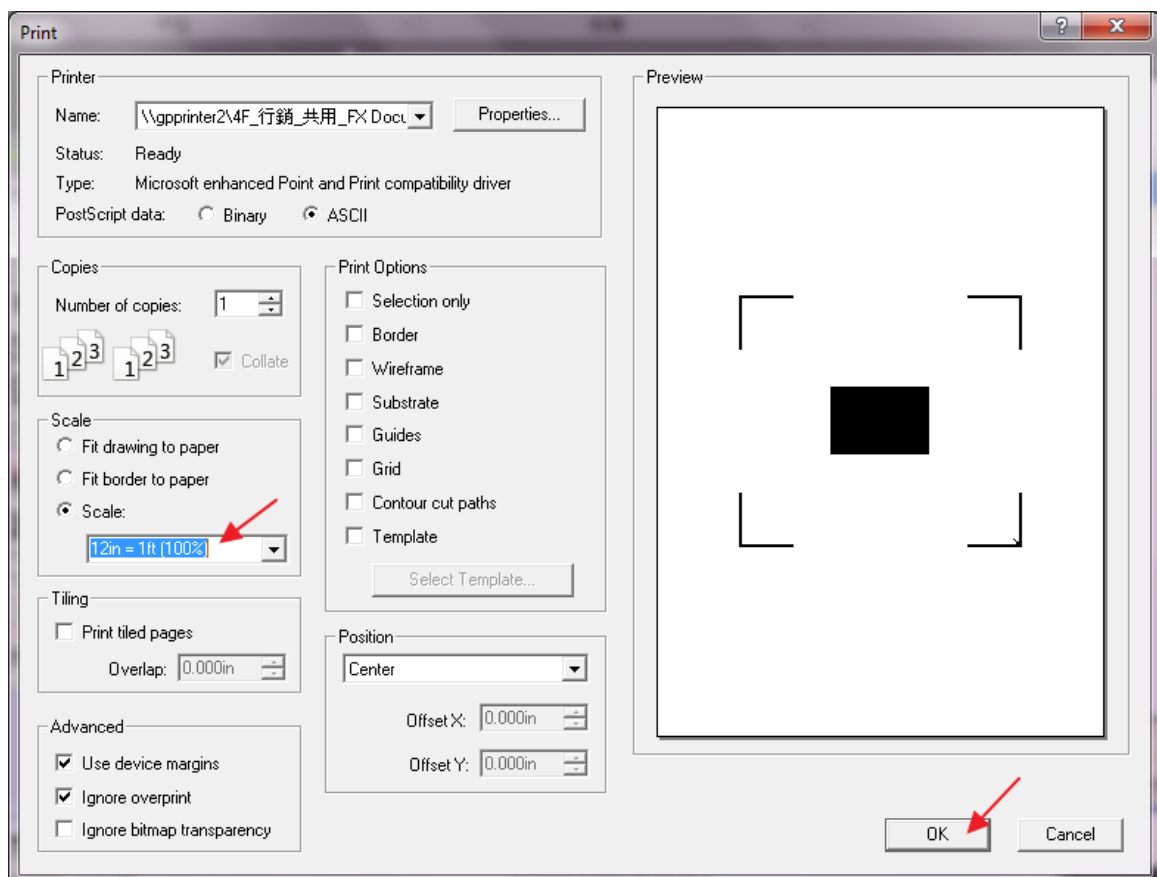

9. Load the printout vinyl on the plotter and select **File > Cut Contour** to send data. You can preview the job and change cutter's parameter settings in 'Properties' tab of Cut Contour window. The Production Manager will be automatic activated to complete the job.

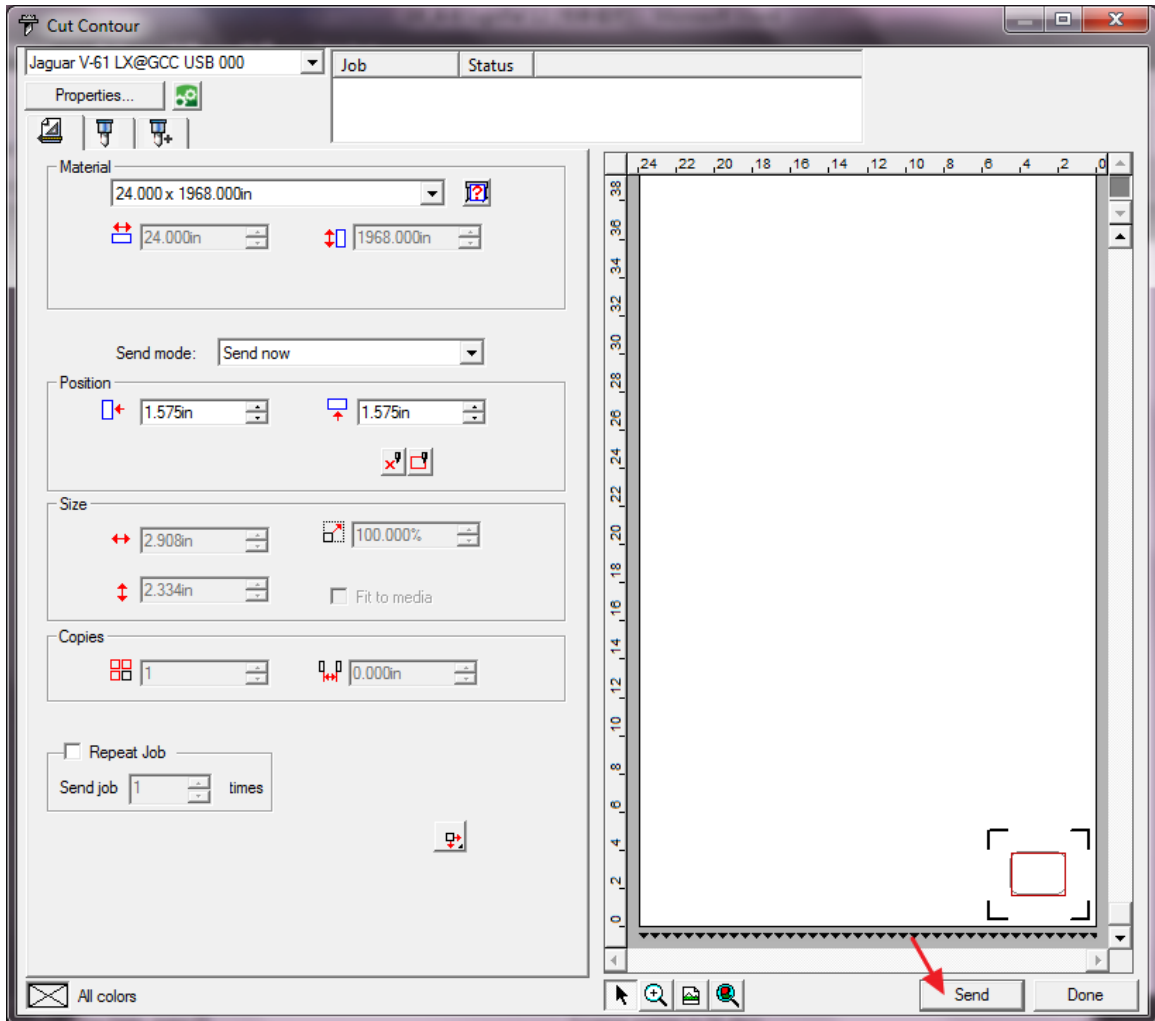
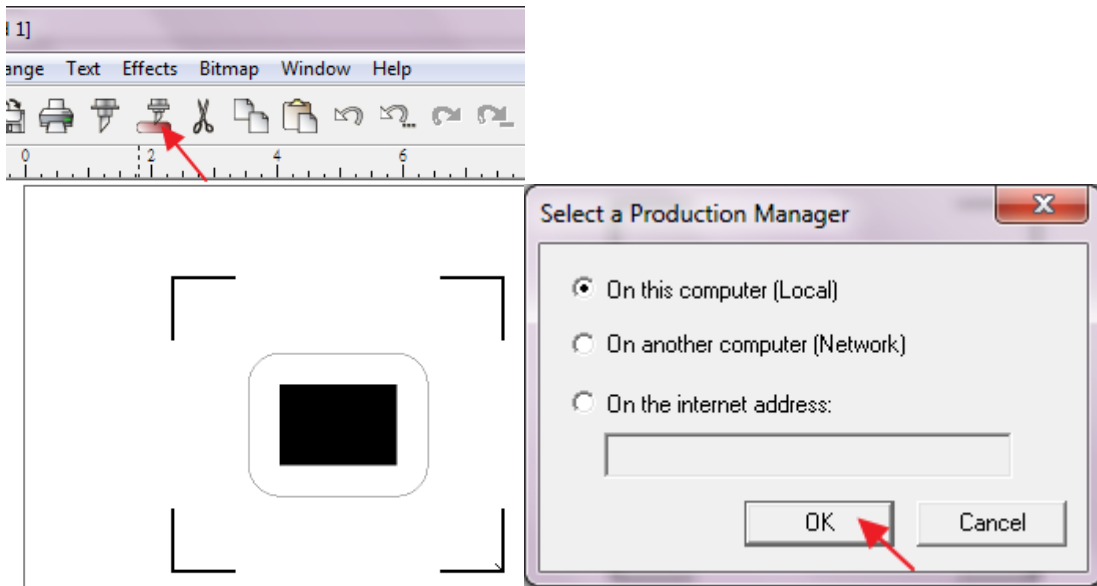

[4] SignPal 12 Features List

	Expert	Apprentice
Text		
Text Tool	•	•
Arc Text	•	
Path Text	•	
Vertical Text	•	•
Vertical Path Text	•	
Kerning	•	
Break Apart/ Join	•	•
Drawing		
Bezier	•	•
Freehand Drawing	•	•
Shapes		
Rectangle	•	•
Oval	•	•
Registration Mark Tool	•	•
Measure Tool	•	•
Path Editing		
Select Point Tool	•	•
Remove Point	•	
Add Point	•	
Straighten Path	•	
Round Corner	•	
Sharpen Corner	•	
Optimize by Curve	•	
Optimize by Smooth		
Arc	•	
Optimize by 3point Arc	•	
Make Arc	•	
Reduce Points	•	
Close Path	•	
Change Start Point	•	
Cleaver	•	

Scissors	•	
Make Right Angle	•	
Break Path	•	
Join Paths	•	
Align Horizontal	•	
Align Vertical	•	
Align Points	•	
Apply Length and Angle	•	
Remove Tiny Objects	•	
Vector Eraser	•	
Cleaver by Path	•	

Working with Files

Job Info	•	
Scanning	•	
Achieve to Cloud	•	•
Workspaces	•	•

View

DesignCentral	•	•
Color Mixer	•	•
Snap	•	•

Arrange

Group	•	•
Compound	•	•
Mask	•	•
Guides	•	•
Contour Cut	•	•
Convert to Outlines	•	•
Convert Stroke to Outlines	•	•
Convert Linked to Native	•	•
Path Direction	•	•
Order	•	•
Cut Order	•	•

Align	•	•
Spacing	•	•
Rotate	•	•
Resize	•	•
Deskew	•	•
Mirror	•	•
Step and Repeat	•	

Effects		
Combine	•	
Outline	•	
Contour Cut	•	•
Contour Cut Mark	•	•
Shadow	•	

Bitmap		
Autotrace	•	
Color Mode	•	

Production		
Cut/Plot	•	•
Manual Split Lines	•	•
Tile All Copies	•	•
Panel to Border	•	•
Auto-weld	•	•
Auto-trap	•	•
Overcut	•	•
Optimize Cutting Order	•	•

Sure Cuts A Lot

There are basic instructions of Sure Cut A Lot below. If you need detailed instruction, please refer to Sure Cut A Lot Help.

1. Select the cutter you want to output and change the work area.

Step 1 Run Sure Cuts A Lot software.

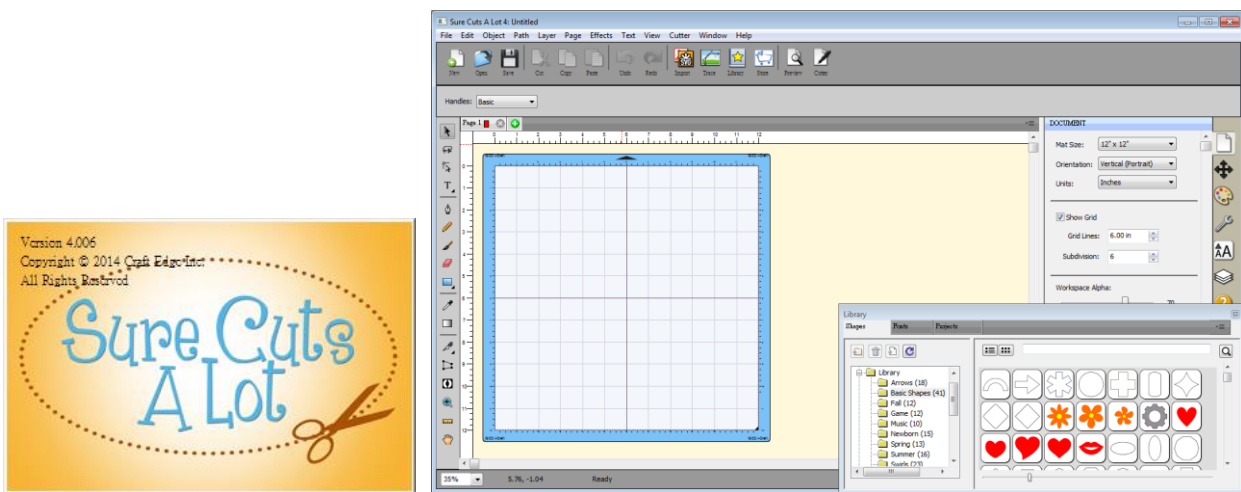

Step 2 Select "Cutter" and select "Manage Cutters" under My Cutter to change the work area.

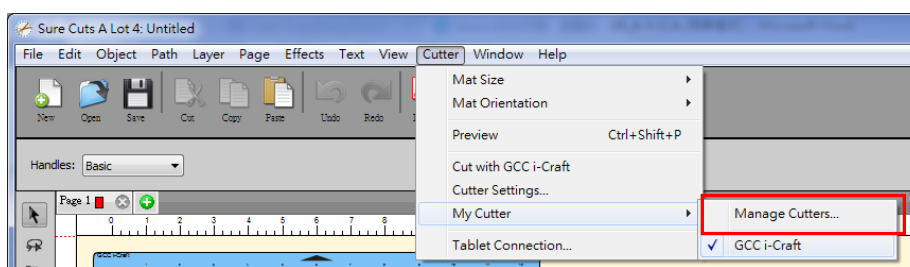

Step 3 Select company / brand as GCC and select model you want to output and then click the “<--Add to list” button.

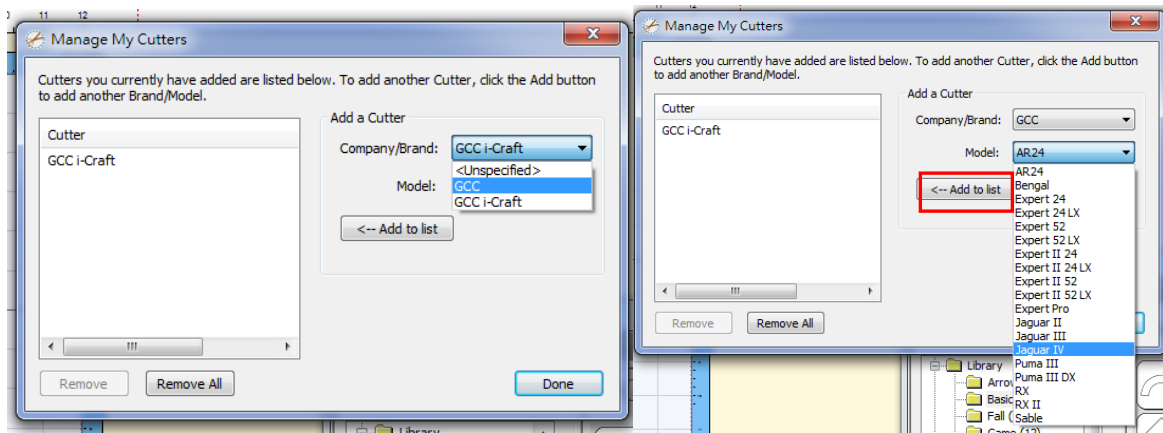

Step 4 Select GCC on the left and click “Done.”

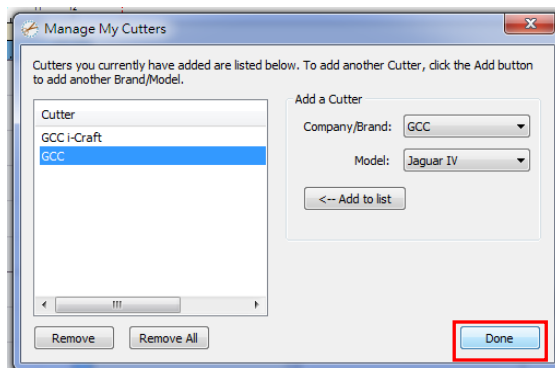

Step 5 If you want to change the material size and orientation, you can fill a proper value in the Document window.

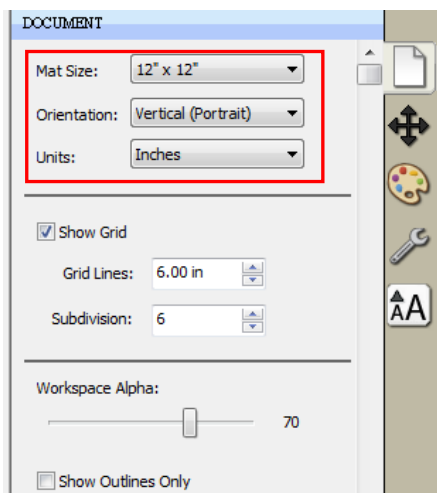

2. Insert Graphics from Library

Step 1 Select graphics from library to insert a selected design.

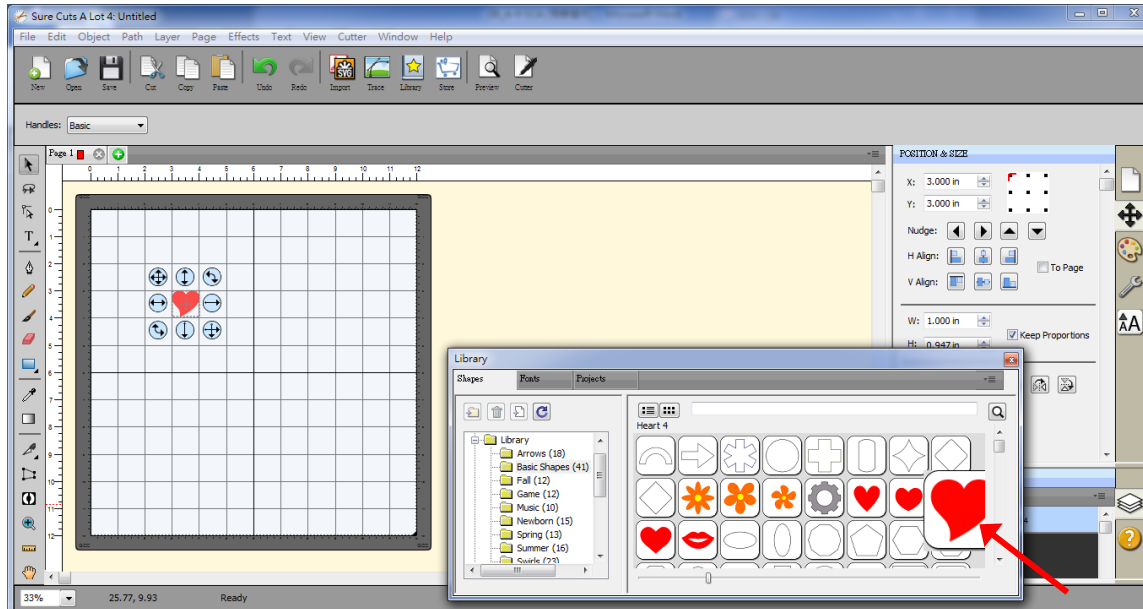

3. Draw Text

Click on the T icon at left side to create the text and select the font you like at text window.

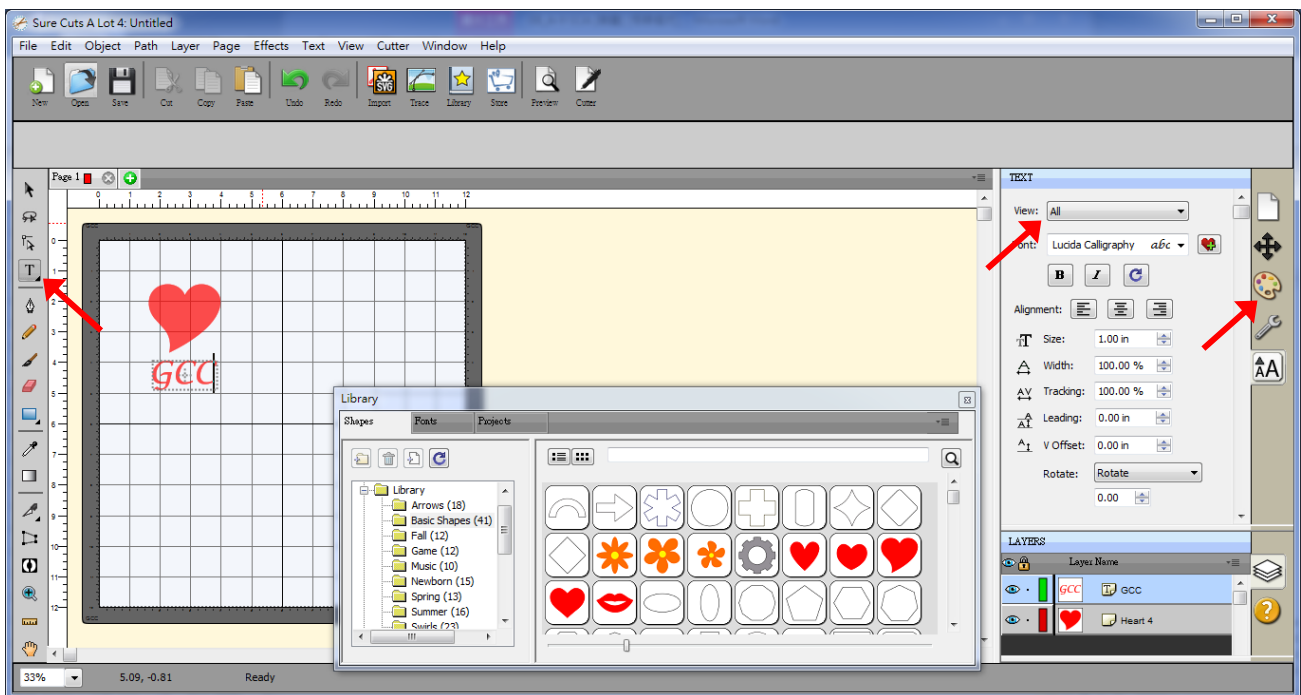

4. Import Design

If you have created your design in other design software, go to “import” or “place image” under file to import it, SCA supports svg, scut, scal, pdf, ai. wpc eps, bmp, gif, jpg and png files.

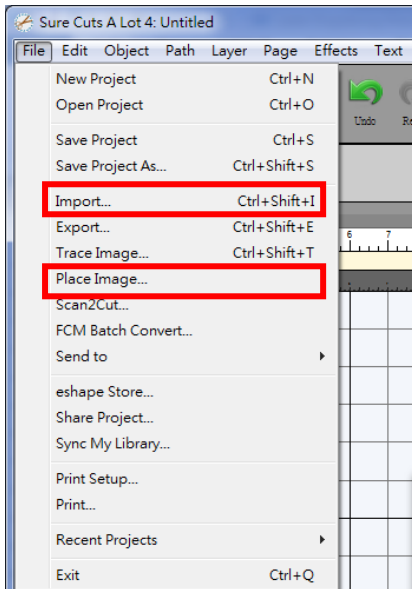

Tips Thousands of SVG files designed specifically for Sure Cuts A Lot!

- ✓ <http://SVGCuts.com> is the top of source for designer SVG files for Sure Cuts A Lot. Thousands of high quality elements including: shapes for card-making, scrapbooking, as well as gift bags, boxes and 3D flowers.

5. Convert Image to Cutting File

Step 1 Go to Trace Image under File, or select Trace Image button on the toolbar to open the setting window.

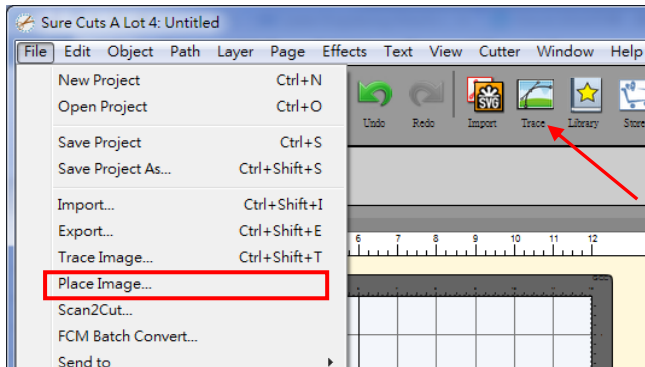

Step 2 Click on “Choose an image” to input the image, adjust Image Settings and Output Settings, and click OK. Then the outline of the image will be outputted automatically.

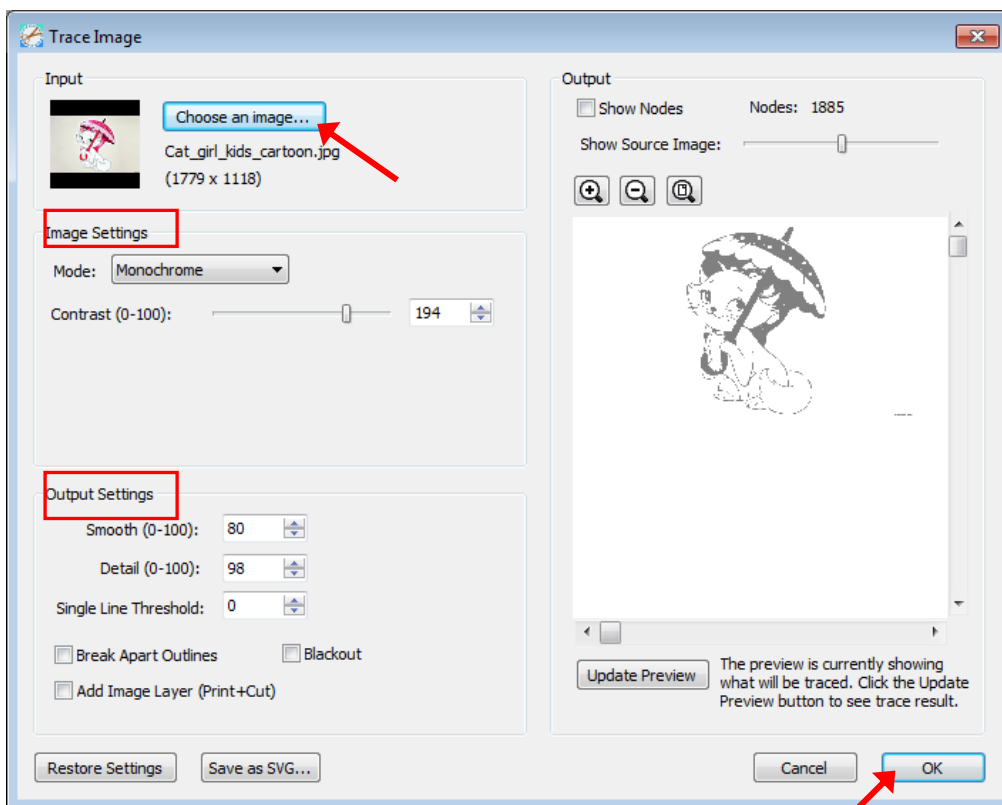

Note

- ✓ The **contrast** and **pixels** of import images will affect the trace image result. High contrast graphics are recommended.

6. Cut the Design

Step 1 Click on the “Cutter” button on the toolbar and Cut Settings window will appear.

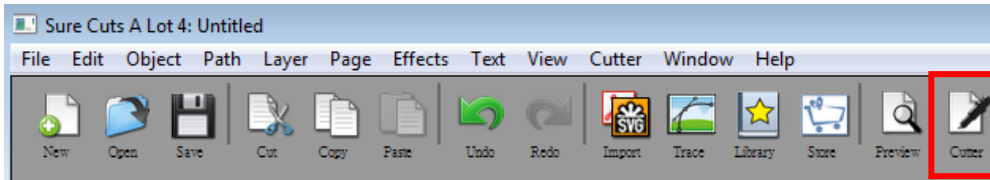

Step 2 Click on “Settings...” to open GCC Cutter Settings window.

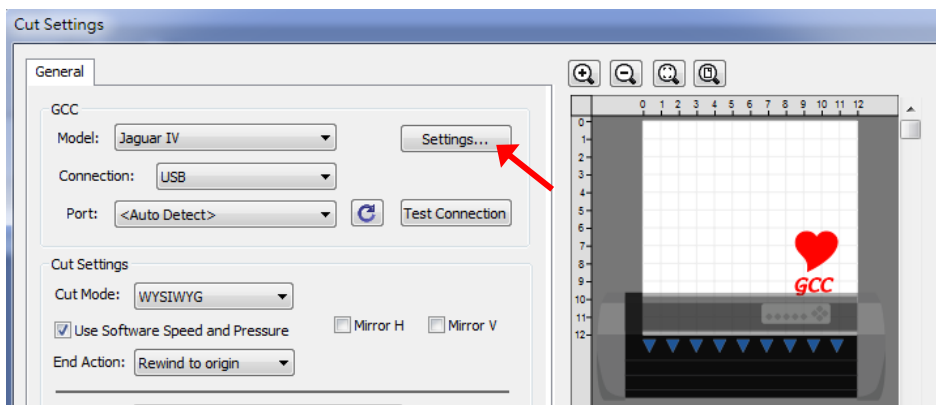

Note

- ✓ The origin point is on the bottom right.

Step 3 Adjust Registration Marks setting under GCC Cutter Settings window if needed.

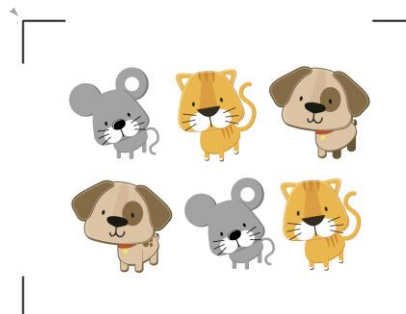
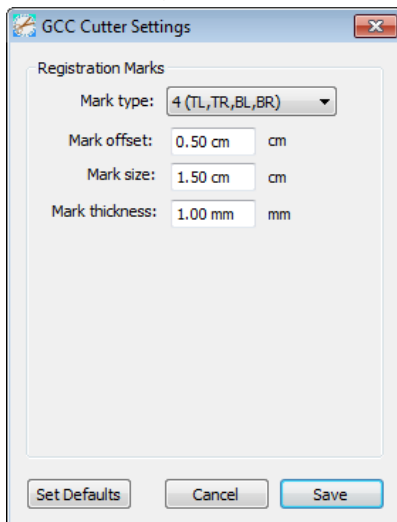

***Registration Marks:** set the distance between the edge of the material and the registration marks in Mark Offset; set the size of marks in Mark Size; set the line thickness of marks in Mark Thickness.

Step 4 Adjust Blade Offset, Overcut Value, Multi-Cut and Quality under Cut Settings window if needed.

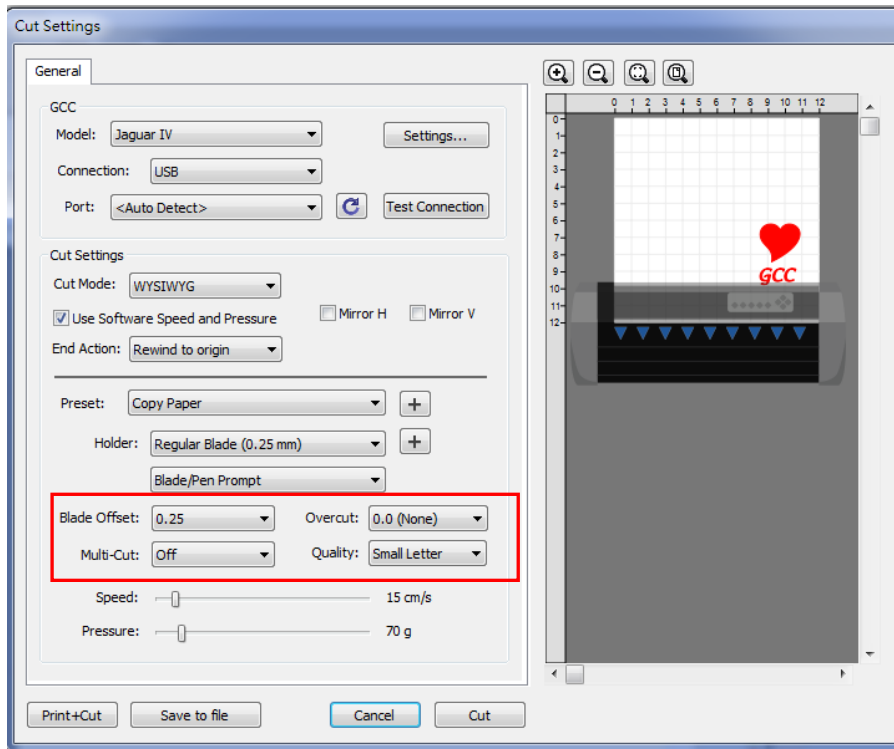

***Blade Offset:** set the offset value according to different blade, for a standard blade, set the offset value at 0.25mm, 0.5mm for an optional advanced blade and 0mm for an optional plotting pen.

***Quality:** associated with the cutting result; please note the better cutting quality, the slower cutting speed.

***Multi-Cut:** to repeat the cutting job at same position which is suitable for cutting thick material.

***Overcut:** allows for easier weeding and makes up for incomplete cut lines.

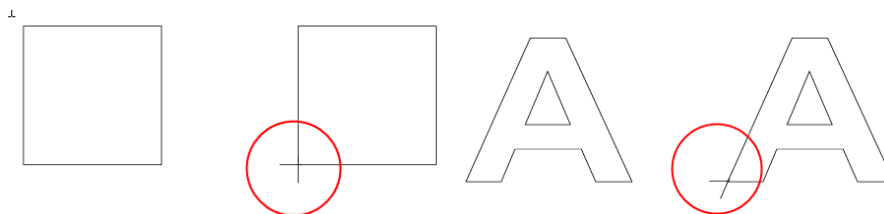

Step 5 Under “Cut Settings” section, there are some useful functions. After setting the parameters, click on “Cut” to send the data to the GCC cutter and the GCC cutter will start the cutting job.

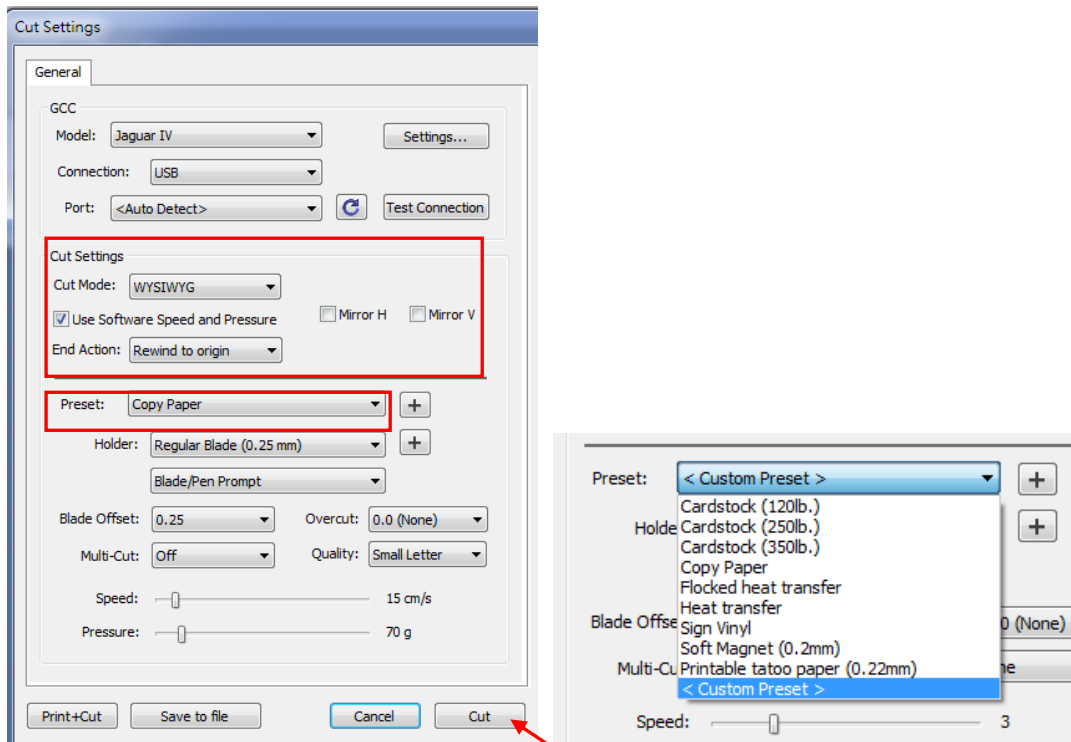

***Cut Mode**: there are “WSIWYG” and “Origin Point” options, WSIWYG means what you see is what you get, the cutter will output the graphic at same position in preview window. While with Origin Point mode, the cutter will cut the graphic from bottom right origin point of the material.

***Use Software Speed and Pressure**: tick this section, and you can set the values of speed and pressure manually.

***Preset**: select a proper material to apply the preset speed and pressure parameter automatically.

***Speed & Pressure**: you may adjust values of speed and pressure manually to get quality results.

7. Print and Cut Your Design

The Print and Cut function allows you to print the graphics from Sure Cuts A Lot to printer, and then put the printed materials on the GCC cutter to cut out the contour of printed jobs from Sure Cuts A Lot.

Step 1 Open an image file in Sure Cuts A Lot.

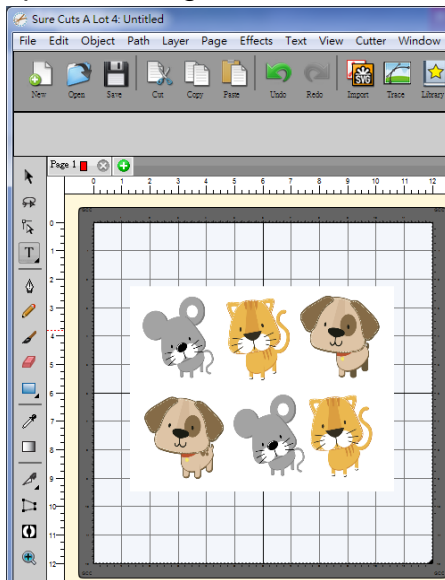

Step 2 Click on the Cutter icon on the toolbar, set the parameters and click on “Print+Cut” to add the registration marks and print out the image.

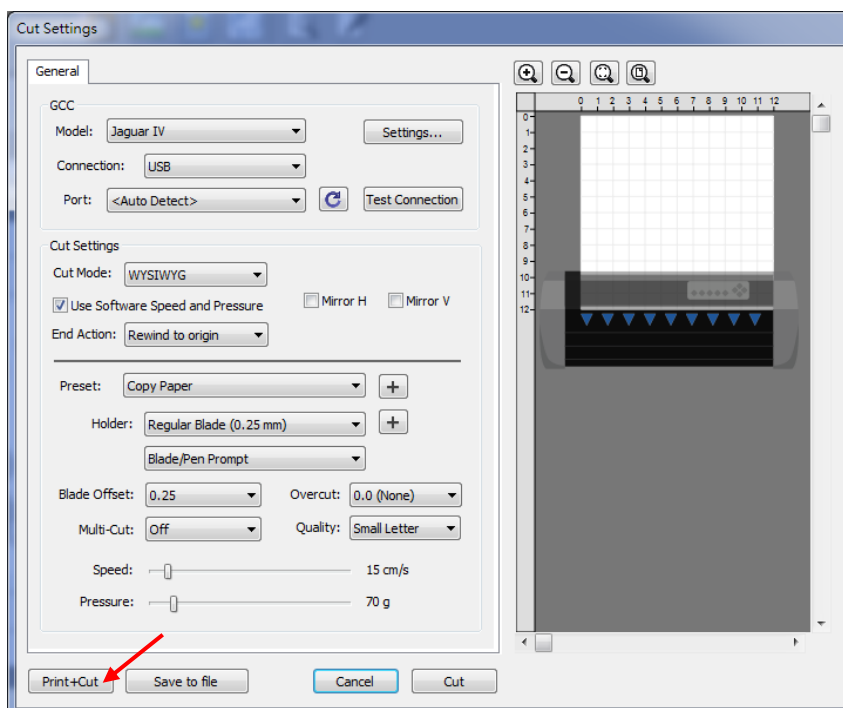

Step 3 Click on “Print...” to open printer setting window and click OK.

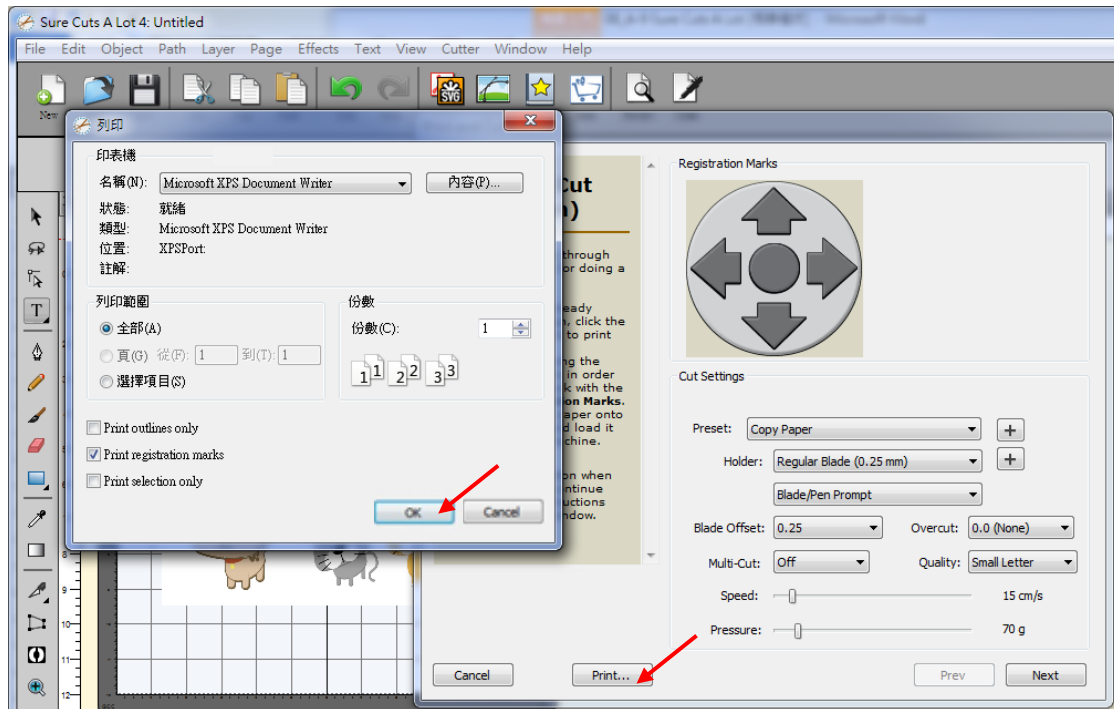

Step 4 Print your design with registration marks out.

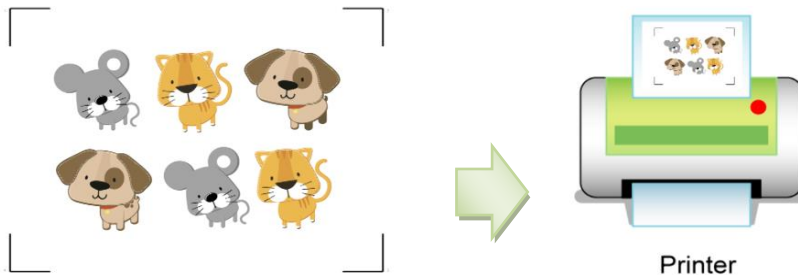

Step 5 Load the printed media to the GCC cutter.

Step 6 Press “Next” and then press “Scan+Cut”, and then the GCC cutter will detect the registration marks and cut the contour lines automatically.

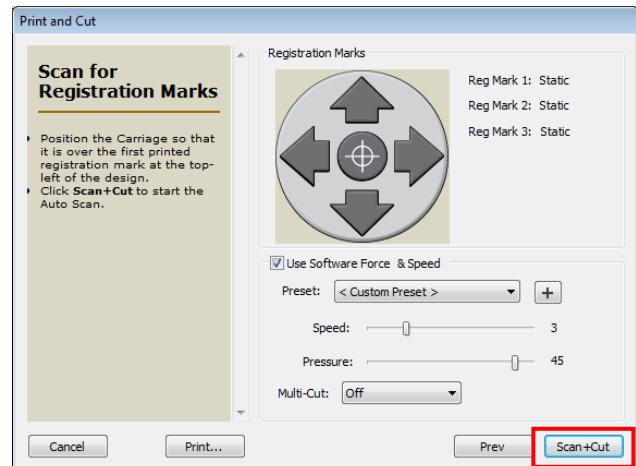
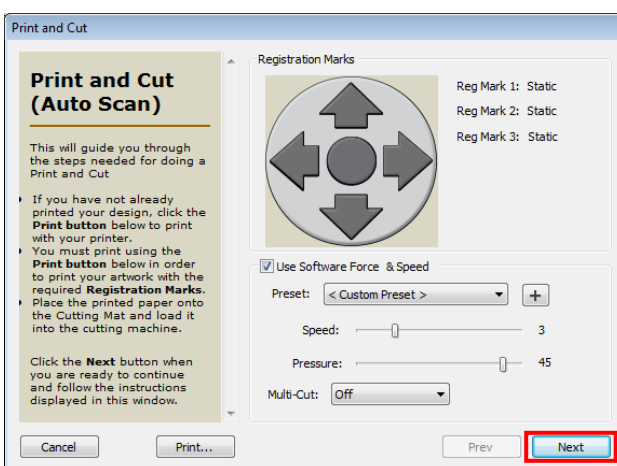

Tips Test Connection function can save your materials.
✓ Click on “Test Connection” to exam if set the connection properly.

